

ED 023 879

08

VT 006 862

By -Duncan, Otis Dudley; And Others

Socioeconomic Background and Occupational Achievement: Extensions of a Basic Model. Final Report.

Michigan Univ., Ann Arbor.

Spons Agency -Office of Education (DHEW), Washington, D.C. Bureau of Research.

Bureau No -BR -5 -0074

Pub Date May 68

Contract -OEC -5 -85 -072

Note -312p.

EDRS Price MF -\$1.25 HC -\$15.70

Descriptors - \*Achievement, Aspiration, Behavioral Science Research, Children, Employment Experience, Ethnic Origins, Family Environment, Income, Intelligence, Marital Instability, Models, Motivation, Occupational Aspiration, \*Occupational Mobility, \*Occupations, Race, \*Socioeconomic Background, Socioeconomic Influences, Statistical Analysis, \*Status

To synthesize knowledge concerning factors which affect occupational achievement through a set of explicit models based upon the concept of the socioeconomic life cycle, six major bodies of data from various sources were collected and subjected to secondary analysis. A number of items of lesser scope were gleaned from additional sources for use in particular analyses. The technique of path analysis was utilized as a methodological approach for interpreting choice of appropriate statistics. The basic model of occupational achievement specifies family socioeconomic background and educational attainment as influences on the level of occupational status achieved. National origin, race, family size, stability, intelligence, aspirations, motivation, influences of others, first job, migration, disruption of marriage, fertility, and child spacing were used in elaborations of the basic model, and income, subjective achievement, and occupational status were utilized as outcomes. Analysis of substantial bodies of data provided estimates of the relative strength of factors influencing achievement for the adult male population. (DM)

BR-5-0074  
PA 08

FINAL REPORT  
Project No. 5-0074 (EO-191)  
Contract No. OE-5-85-072

SOCIOECONOMIC BACKGROUND AND OCCUPATIONAL ACHIEVEMENT:  
EXTENSIONS OF A BASIC MODEL

07 68-2

May 1968

U.S. DEPARTMENT OF  
HEALTH, EDUCATION, AND WELFARE

Office of Education  
Bureau of Research

VT006862

ED023879

Final Report  
Project No. 5-0074 (EO-191)  
Contract No. OE-5-85-072

U.S. DEPARTMENT OF HEALTH, EDUCATION & WELFARE  
OFFICE OF EDUCATION

THIS DOCUMENT HAS BEEN REPRODUCED EXACTLY AS RECEIVED FROM THE  
PERSON OR ORGANIZATION ORIGINATING IT. POINTS OF VIEW OR OPINIONS  
STATED DO NOT NECESSARILY REPRESENT OFFICIAL OFFICE OF EDUCATION  
POSITION OR POLICY.

SOCIOECONOMIC BACKGROUND AND OCCUPATIONAL ACHIEVEMENT:  
EXTENSIONS OF A BASIC MODEL

Otis Dudley Duncan, *and others*  
David L. Featherman  
Beverly Duncan  
The University of Michigan  
Ann Arbor, Michigan

May 1968

The research reported herein was performed pursuant to a contract with the Office of Education, U. S. Department of Health, Education and Welfare. Contractors undertaking such projects under Government sponsorship are encouraged to express freely their professional judgment in the conduct of the project. Points of view or opinions do not, therefore, necessarily represent official Office of Education position or policy.

U. S. DEPARTMENT OF  
HEALTH, EDUCATION, AND WELFARE

Office of Education  
Bureau of Research

## PREFACE

This project was planned to take up where two previous inquiries left off. These studies--Peter M. Blau and Otis Dudley Duncan, The American Occupational Structure (1967), and Beverly Duncan, Family Factors and School Dropout: 1920-1960 (1965)--were both largely devoted to the analysis of a single body of data, those derived from the March 1962 survey of the Bureau of the Census, "Occupational Changes in a Generation." This source was supplemented by various pieces of census information, but there was no opportunity to consider a range of variables not normally available in such sources. At the same time, some interesting analytical possibilities of the OCG data themselves were passed over in view of limitations on resources for analysis. In broadening the scope of research on occupational achievement by comparison with the earlier studies, we have continuously had in mind the ideal of extending, enlarging, or improving the models presented in them. Such an ideal, if it be practical to adhere to it, offers promise of generating a truly cumulative body of knowledge.

The arduous and complex tasks of an ambitious research effort can hardly be performed by a project director alone. It is appropriate to acknowledge first the substantial contributions of the two co-authors: David L. Featherman has been a member of the project staff since its inception; he worked particularly on the materials in Chapters 6, 7, and 8. Beverly Duncan was primarily responsible for sections of Chapter 5 and Chapter 9 and two of the separately published project reports. The two of them jointly supervised a special project involving coding of the DAS occupation data used in sections 4.2, 6.5, and 7.6.

As in the case of the two previous monographs, acknowledgment is due to the staff of the United States Bureau of the Census for its work in conducting the survey of "Occupational Changes in a Generation" and processing the data through the first stage of tabulation.

This project relied heavily on data collected by other investigators who generously permitted us to make use of them in our own way. We greatly appreciate the professional and personal courtesy of C. Norman Alexander, Jr., Ernest Q. Campbell, Harry J. Crockett, Jr., LaMar T. Empey, Archibald O. Haller, Albert D. Klassen, Jr., Edward O. Laumann, Alejandro Portes, Howard Schuman, William H. Sewell, and Charles F. West-off. None of them is responsible for our conclusions.

We wish further to acknowledge the indispensable contributions of the research staff. Bruce L. Warren, Elliot M. Long, and James N. Porter served as research assistants at various times, and Warren wrote a memorandum on which a portion of section 6.1 is based. Ruthe C. Sweet and Susan Bittner, working under the supervision of J. Michael Coble, were responsible for computer programming and data processing. James C. Cramer, Griffith Feeney, Neil Paterson, Steven Peters, Ellen Shantz, and Alexandra Stavrou were part-time statistical clerks. Joanne Raymond, William Allen, and Linda Warren carried out occupational coding. Mary Scott and Alice Y. Sano typed the manuscript. The continuity of the project under often trying circumstances was assured by the resourceful administrative actions taken by Helen Dempster.

The project was conducted at the Population Studies Center of The University of Michigan. The facilities it offered, as well as the atmosphere of dedication to research that it provided, made it possible to carry on our work.

Otis Dudley Duncan  
Project Director

## CONTENTS

<u>Chapter</u>	<u>Page</u>
Preface . . . . .	iii
Summary . . . . .	1
1. Framework and Strategy . . . . .	9
1.1. The Process of Achievement . . . . .	10
1.2. The Socioeconomic Life Cycle . . . . .	12
1.3. Incremental Strategy of Model Building . . . . .	16
1.4. Prospectus . . . . .	22
2. Methods and Models . . . . .	24
2.1. A Recursive Model . . . . .	25
2.2. Reduced Forms . . . . .	30
2.3. Partial, Partitions, and Paths . . . . .	33
3. Sources of Data . . . . .	44
3.1. Description of Data Sets . . . . .	45
4. The Basic Model . . . . .	50
4.1. Occupational Achievement in Four Cohorts . . . . .	50
4.2. Replication and Scales of Measurement . . . . .	59
5. Background Variables . . . . .	64
5.1. National Origins . . . . .	65
5.2. Race . . . . .	69
5.3. Number and Sex of Siblings . . . . .	76
5.4. Family Stability . . . . .	78
6. Intervening Variables, I: Intelligence . . . . .	80
6.1. Observations on the Concept of Intelligence . . . . .	80
6.2. Correlates of Intelligence . . . . .	92
6.3. Preliminary Models . . . . .	101
6.4. Ability and Achievement: Final Model . . . . .	114
6.5. Ability and Achievement: A Replication . . . . .	118
7. Intervening Variables, II: Aspirations and Motives . . . . .	120
7.1. Measurement of Aspirations . . . . .	121
7.2. Measurement of Plans . . . . .	126
7.3. Measurement of Motivation . . . . .	131
7.4. Inferences about Motives . . . . .	145
7.5. Aspirations as Indicators of Motivation . . . . .	150
7.6. Hypotheses about Indicators of Motivation . . . . .	162
8. Intervening Variables, III: Social Influences . . . . .	182
8.1. Wives and Mothers . . . . .	182
8.2. On the Development of Parents' Aspirations . . . . .	199
8.3. Parents and Peers . . . . .	205
8.4. Peers and Schools . . . . .	207

<u>Chapter</u>	<u>Page</u>
9. Career Contingencies . . . . .	222
9.1. First Job . . . . .	222
9.2. Age at First Job . . . . .	227
9.3. Migration . . . . .	243
9.4. Disruption of Marriage . . . . .	251
9.5. Marital Fertility . . . . .	255
9.6. Childspacing . . . . .	265
10. Conclusions . . . . .	274
References . . . . .	277
Appendix A. Publications and Spinoff . . . . .	283
A.1. List of Project Reports Prepared for Separate Publication . . . . .	283
A.2. Spinoff: Related Work . . . . .	284
A.3. Dissertations Related to the Project . . . . .	284
Appendix B. Supplementary Tables . . . . .	286
ERIC Report Resume . . . . .	296

LIST OF TABLES

<u>Table</u>	<u>Page</u>
4.1.1.--Simple Correlations between Variables Entering into the Basic Model, for Non-Negro Men with Nonfarm Background, in Experienced Civilian Labor Force, by Age: March 1962 . . .	51
4.1.2.--Partial Regression Coefficients in Standard Form for Recursive Model Relating Achieved Statuses to Family Background Factors, by Age, for Non-Negro Men with Nonfarm Background, in Experienced Civilian Labor Force: March 1962 . . . . .	54
4.1.3.--Partial Regression Coefficients in Standard Form for Reduced Form of Recursive Model Relating Achieved Statuses to Family Background Factors, by Age, for Non-Negro Men with Nonfarm Background, in Experienced Civilian Labor Force: March 1962 . . . . .	57
4.2.1.--Simple Correlations in OCG and DAS Data Sets, with Alternative DAS Results for Different Measures of Occupational Status . . . . .	60
5.1.1.--Effect of National Origin on Mean Occupational Status, for Native White Civilian Men of Nonfarm Background: Age 25-64, with Foreign Fathers: March 1962 . . . . .	66
5.2.1.--Transition Percentages, Father's Occupation to 1962 Occupation (Condensed Classification), by Race, for Civilian Men 25 to 64 Years Old, March 1962 . . . . .	70
5.2.2.--Differences in Means between White (W) and Negro (N) with Respect to Number of Siblings, Educational Attainment, Occupational Status, and Income, with Components of Differences Generated by Cumulative Effects in a Model of the Socioeconomic Life Cycle, for Native Men, 25 to 64 Years Old, with Nonfarm Background and in the Experienced Civilian Labor Force: March 1962 . . . . .	74
6.1.1.--Barr Rating, Occupation Title, and Description, with Matching Group Socioeconomic Status Score (SES) and NORC Prestige Rating for Occupations Included in Barr Scale . . . . .	82
6.1.2.--F-Tests for Covariance Analysis . . . . .	89
6.2.1.--Per Cent Distribution by Educational Attainment, for Persons 25-34 Years Old Living in Minneapolis in 1940 and for Sample Studied by Benson . . . . .	97
6.3.1.--Correlations Used in Estimating Path Coefficients in Model 6.3.2 . . . . .	103



<u>Table</u>	<u>Page</u>
7.1.1.--Summary of Regressions of Student's Occupational Aspirations and Plans on Father's Occupation, Based on Data of Stephenson (1957) . . . . .	122
7.1.2.--Empey's Data on Occupational Aspiration, with Derived Statistics . . . . .	123
7.2.1.--Coefficients of Determination for Models A and B . . . . .	129
7.3.1.--Frequency Distributions of Respondents' and Fathers' Occupational Statuses, SRC Data Used by Crockett . . . . .	133
7.3.2.--Means and Standard Deviations of Occupational and Educational Variables . . . . .	135
7.3.3.--Redistribution of Crockett's North-Hatt Codes 68-69 . . . . .	138
7.3.4.--Distribution of Occupational Response Items in Table 7.3.3 by Estimated Ambiguity . . . . .	138
7.3.5.--Zero-Order Correlation Matrix for 314 Located Schedules . . . . .	140
7.5.1.--Intercorrelations of Selected Variables in WISC Data Set . . . . .	152
7.5.2.--Components of the SES Index Used in the WISC Data Set . . . . .	154
7.6.1.--Correlation Matrix for Selected Variables in DAS Data Set . . . . .	170
7.6.2.--Correlations of Hypothetical Variables with Observed Variables in DAS Data Set; and Correlations of Social Class with Other Observed Variables Implied by Model in Figure 7.6.1 . . . . .	175
7.6.3.--Partial Regression Coefficients in Standard Form for Regressions of Occupational Status and Educational Attainment on Prior Variables in the Model Shown in Figure 7.6.1 . . . . .	176
8.1.1.--Comparison of Occupational Distributions of Fathers and Sons in FGMA Data and OCG Sample of Urbanized Areas with Populations of One Million or More . . . . .	185
8.1.2.--Comparison of Zero-Order Correlations of Mobility Variables in FGMA Data and for OCG Males, Age 25-34, Nonfarm Background . . . . .	189
8.1.3.--Zero-Order Correlation Matrix for FGMA Data . . . . .	197
8.2.1.--Correlation Matrix for Analysis of Parental Aspirations . . . . .	202
8.4.1.--Average Within-School Correlations in WISC and MICH Data Sets . . . . .	219

<u>Table</u>	<u>Page</u>
9.1.1.--Partial Regression Coefficients in Standard Form for Relationships of First Job and Current Occupational Status to Family Background Factors, by Age, for Non-Negro Men with Nonfarm Background, in Experienced Civilian Labor Force: March 1962 . . . . .	224
9.2.1.--Percentage Distribution by Age at First Job for Native Civilian Non-Negro Males Aged 25 to 64 with Nonfarm Background in Eight Strata Defined by Educational Attainment: March 1962 . . . . .	229
9.2.2.--Mean Socio-economic Status Score of Occupations Held by Native Civilian Non-Negro Males Aged 25 to 64 with Nonfarm Background in 40 Strata Defined by Age at First Job and Educational Attainment: March 1962 . . . . .	231
9.2.3.--Relation of Respondent's Current to First Occupation for Native Civilian Non-Negro Males Aged 25 to 64 with Nonfarm Background in 40 Strata Defined by Age at First Job and Educational Attainment: March 1962 . . . . .	235
9.2.4.--Mean Socio-economic Status Score of Occupation and Mean Number of Grades Completed for Family Heads of Native Civilian Non-Negro Males Aged 25 to 64 with Nonfarm Background in 40 Strata Defined by Age at First Job and Educational Attainment: March 1962 . . . . .	237
9.2.5.--Relation of Respondent's Current and First Occupations to Family Head's Occupation for Native Civilian Non-Negro Males Aged 25 to 64 with Nonfarm Background in 40 Strata Defined by Age at First Job and Educational Attainment: March 1962 . . . . .	239
9.2.6.--Means of Respondent's Number of Siblings and His Oldest Brother's Schooling for Native Civilian Non-Negro Males Aged 25 to 64 with Nonfarm Background in 40 Strata Defined by Age at First Job and Educational Attainment: March 1962 . . . . .	240
9.2.7.--Mean Scores and Standard Deviations on Selected Variables for College Graduates, by Age at First Job, in the Population of Native Civilian Non-Negro Men Aged 25 to 64 with Nonfarm Background: March 1962 . . . . .	242
9.3.1.--Mean Occupational Status Scores for Native Non-Negro Men 25 to 64 Years Old Living in Nonfarm Residences and in the Experienced Civilian Labor Force, by Migration Status: March 1962 . . . . .	245
9.3.2.--Regression Coefficients Describing Relationship of Occupational Status (Y) to Family Background, by Migration Status, for Native Non-Negro Men 25 to 64 Years Old Living in Nonfarm Residences and in the Experienced Civilian Labor Force: March 1962 . . . . .	246

<u>Table</u>	<u>Page</u>
9.3.3.--Regression Coefficients Describing Relationship of Occupational Status (Y) to Family Background and Educational Attainment, by Migration Status, for Native Non-Negro Men 25 to 64 Years Old Living in Nonfarm Residences and in the Experienced Civilian Labor Force: March 1962 . . . . .	247
9.3.4.--Gross and Net Effects of Migration Status on Occupational Status, by Size of Place, for Native Non-Negro Men 25 to 64 Years Old Living in Nonfarm Residences and in the Experienced Civilian Labor Force: March 1962 . . . . .	249
9.3.5.--Mean Number of Years of School Completed, by Migration Status, for Native Non-Negro Men 25 to 64 Years Old Living in Nonfarm Residences and in the Experienced Civilian Labor Force: March 1962 . . . . .	252
9.4.1.--Mean Scores and Standard Deviations on Selected Variables for Native Non-Negro Civilian Males Age 25 to 64, with Nonfarm Background and Reared with Both Parents, by Current Marital Status: March 1962 . . . . .	254
9.4.2.--Summary of Effects of Current Marital Status on Occupational Achievement, for the Population Covered in Table 9.4.1 . . . . .	256
9.5.1.--Partial Regression Coefficients in Standard Form Relating Fertility, Husband's Occupation, and Income to Socioeconomic Background, for Intact White Couples, by Age of Wife: Civilian Noninstitutional Population of the United States, 1962 . . . . .	260
9.5.2.--Simple Correlations between Fertility and Socioeconomic Variables, for Intact White Couples, by Age of Wife: Civilian Noninstitutional Population of the United States, 1962 . . . . .	263
9.6.1.--Means of Selected Variables by Interval from Marriage to First Birth, for Special OCG Subpopulation (Defined in the Text): March 1962 . . . . .	269
9.6.2.--Deviations of Means, by Interval from Marriage to First Birth, from Grand Mean (Gross Effects) and from Values Expected from Regression on Background Factors V,X,T (Net Effects), for Selected Variables Taken from Table 9.6.1 . . . . .	271
9.6.3.--Gross and Net Effects of Interval from Marriage to First Birth on Occupational Status in 1962 (Y), for Special OCG Subpopulation . . . . .	272

Table

Page

B.1.--Correlation Matrix from OCG Data on Native non-Negro Men, 25 to 64 Years Old, in the Experienced Civilian Labor Force: March 1962 . . . . .	288
B.2.--Correlation Matrix from OCG Data on Native non-Negro Men with Nonfarm Background, 25 to 64 Years Old, in the Experienced Civilian Labor Force: March 1962 . . . . .	289
B.3.--Correlation Matrix from OCG Data on Native Negro Men, 25 to 64 Years Old, in the Experienced Civilian Labor Force: March 1962 . . . . .	290
B.4.--Correlation Matrix from OCG Data on Native Negro Men with Nonfarm Background, 25 to 64 Years Old, in the Experienced Civilian Labor Force: March 1962 . . . . .	291
B.5.--Correlation Matrix from OCG Data on Native non-Negro Men with Nonfarm Background, 25 to 34 Years Old, in the Experienced Civilian Labor Force: March 1962 . . . . .	292
B.6.--Correlation Matrix from OCG Data on Native non-Negro Men with Nonfarm Background, 35 to 44 Years Old, in the Experienced Civilian Labor Force: March 1962 . . . . .	293
B.7.--Correlation Matrix from OCG Data on Native non-Negro Men with Nonfarm Background, 45 to 54 Years Old, in the Experienced Civilian Labor Force: March 1962 . . . . .	294
B.8.--Correlation Matrix from OCG Data on Native non-Negro Men with Nonfarm Background, 55 to 64 Years Old, in the Experienced Civilian Labor Force: March 1962 . . . . .	295

<u>Figure</u>	<u>Page</u>
1.2.1.--Schematic Representation of the Basic Model of Occupational Achievement . . . . .	15
2.1.1.--Path Diagram Representing Causal Model Implicit in Turner's (1964) Study of the Determinants of Aspirations, with Path Coefficients Estimated from Correlations Reported by Him .	26
2.2.1.--Reduced Forms of Model 2.1.1 with $X_4$ as the Dependent Variable and with $X_5$ as the Dependent Variable . . . . .	31
2.3.1.--Alternative Interpretations in the Three-Variable Problem .	35
2.3.2.--Alternative Interpretations in the Four-Variable Problem .	39
4.1.1.--Basic Model of the Process of Achievement, with Path Coefficients Estimated for Non-Negro Men with Nonfarm Background, 35-44 Years Old, in Experienced Civilian Labor Force, March 1962 . . . . .	53
4.2.1.--Comparison of Results with OCG and DAS Data . . . . .	61
5.1.1.--Correlation of Two Components of Gross National Origin Effects on Occupational Achievement . . . . .	68
5.2.1.--Regression of Respondent's Occupational Status on Father's Occupational Status, for Civilian Men 25 to 64 Years Old, by Race: March 1962 . . . . .	72
5.3.1.--Alternative Models Representing Effects of Number of Brothers and Sisters . . . . .	77
6.2.1.--Scatter Plot, Mean Standard Scores of Ability on Occupational Status of Parent, Wisconsin High School Seniors, 1929-33 (after Byrns and Henmon) . . . . .	95
6.2.2.--Regression of AGCT Score on Previous Civilian Occupational Status . . . . .	99
6.2.3.--Regression of Mental Ability on Occupational Status: AGCT Data from Stewart (1947), GATB Data from U. S. Bureau of Employment Security (1962) . . . . .	102
6.3.1.--Basic Model, with Estimates Based on OCG Data for All Men, 20-64 Years Old . . . . .	104
6.3.2.--Extended Model, Based on Data in Table 6.3.1 . . . . .	104
6.3.3.--Basic Model of Educational Attainment, with Estimates for Native White Men 27-61 Years Old . . . . .	109
6.3.4.--Educational Attainment as a Function of Family Background and Intelligence . . . . .	109

<u>Figure</u>	<u>Page</u>
6.3.5.--Correlation between Siblings in Regard to Educational Attainment, Interpreted in the Light of Model 6.3.4 . . .	111
6.4.1.--Final Model of Ability and Achievement (Upper Diagram) and Reduced Form Omitting Intelligence at Maturity (Lower Diagram) . . . . .	115
6.4.2.--Reduced Forms of Final Model of Ability and Achievement .	116
6.5.1.--Abridged Version of the Final Model of Ability and Achievement, with Path Coefficients Estimated for Two Populations . . . . .	119
7.2.1.--Alternative Interpretations of Sewell's Data on College Plans . . . . .	127
7.3.1.--Scatter Plot of 1965 NORC on 1947 North-Hatt Scores for 44 Matching Titles . . . . .	137
7.3.2.--Crockett Coding Transformed into Duncan Occupational SES Metric . . . . .	142
7.3.3.--PSC Coding into Census and Occupational SES Metric . . .	142
7.3.4.--Crockett Coding Using 1947 North-Hatt Prestige Metric . .	142
7.3.5.--PSC Coding into Census and 1965 NORC Prestige Metric . .	142
7.3.6.--Crockett Coding Transformed into Duncan Occupational SES Metric . . . . .	144
7.3.7.--PSC Coding into Census and Occupational SES Metric . . .	144
7.4.1.--Role of Two Hypothetical Motivational Variables in the Process of Achievement, on Specified Assumptions Concerning Validity of Indicators . . . . .	147
7.4.2.--Role of Two Hypothetical Motivational Variables in the Process of Achievement, on Specified Assumptions Concerning Validity of Indicators . . . . .	148
7.5.1.--Alternative Models Interpreting Aspirations as Indicators of Motivational Factor in Achievement . . . . .	153
7.5.2.--Reduced Forms of Model WISC-1 . . . . .	160
7.5.3.--Reduced Forms of Model WISC-2 . . . . .	161
7.5.4.--Modification of Model WISC-1 to Treat M as Dependent on SES, IQ, and Earlier Motivation (M') and Reduced Form of Modified Model . . . . .	163

<u>Figure</u>	<u>Page</u>
7.6.1.--Hypothetical Factors, F and G, Indicated by Three Observed Variables and Interpreted as Intervening Variables in the Process of Achievement, with Path Coefficients Estimated for DAS Data Set . . . . .	172
7.6.2.--Simplification of Figure 7.6.1 for Use in Estimating Path Coefficients for Indicator Variables and Correlations Involving Hypothetical Factors F and G . . . . .	173
7.6.3.--Alternative Interpretations of Relationship of Hypothetical Factors to Background Variables . . . . .	178
8.1.1.--Path Diagram Showing Husband's Characteristics as Determinants of Husband's Occupational Status . . . . .	190
8.1.2.--Path Diagram Representing Husband's Occupational Status as Depending on Wife's Psychological and Background Characteristics . . . . .	190
8.1.3.--Path Diagram Representing Husband's Occupational Status as a Function of His Background and Wife's Education . . . . .	192
8.1.4.--Initial Path Diagram for Explaining Mother's Aspirations for Her Children's Education . . . . .	194
8.1.5.--Revised Causal Model of Mother's Aspirations for Children's Education . . . . .	194
8.1.6.--Hypothetical Model: Background Influences on Son's Education Through Mother's Aspirations Only . . . . .	196
8.1.7.--Hypothetical Model Modified . . . . .	196
8.2.1.--Development of Parental Aspiration for Child's College Education, Depending on Background Factors, as Represented in Two Models . . . . .	201
8.3.1.--Aspirations of Respondents and Best Friends Related to Family Background, Parental Aspiration, and Friend's Aspirations . . . . .	206
8.4.1.--Causal Interpretation of the Within-School and Between-School Components of the Correlation between Educational Aspirations and Parental Socioeconomic Status in Unpublished Data of Campbell and Alexander . . . . .	210
8.4.2.--Data of Figure 8.4.1 with Between-School Variation in Y due to X Allocated to Compositional ( $\tilde{Y}_j$ ) and Non-Compositional ( $Y_j^*$ ) Components . . . . .	212
8.4.3.--Total, Between-School, and Within-School Correlations for Respondents' and Friends' Educational Aspirations (Y) and Socioeconomic Status (X), Computed from Data of Alexander and Campbell . . . . .	216

<u>Figure</u>	<u>Page</u>
8.4.4.--Model of Peer Influences and Effects of Intelligence and Socioeconomic Status on Educational Aspirations Within Schools Combined with Within-School vs. Between-School Decomposition of Correlation between Friends' Aspirations	220
9.1.1.--Synthetic Cohort Models Based on Combination of Data for Older Cohorts with Those for Men 25-34 Years Old . . . .	225
9.2.1.--Relationships of Mean Status of Current and First Occupations to Age at First Job, within Educational Strata . .	233
9.2.2.--Relationships of Mean Occupational Status and Educational Attainment of Heads of Respondents' Families of Orientation to Respondents' Age at First Job, within Educational Strata . . . . .	238
9.5.1.--Causal Model Interpreting Fertility as a Career Contingency . . . . .	258
9.6.1.--Mean Occupational Status, by Interval from Marriage to First Birth, for Specified (see Text) OCG Subpopulation .	268



## SUMMARY

The first three chapters of this report describe its objectives and strategy, its techniques, and the available data resources. The fourth chapter is an exposition of the basic model for which extensions are attempted in the remaining five chapters. This summary takes the form of a chapter-by-chapter abstract of the content of the report. Details and qualifications of the findings are, of course, suppressed in this concise statement.

Framework and Strategy (Chapter 1). The aim of this research is to synthesize a body of knowledge about factors affecting occupational achievement in terms of a set of explicit models of the process of achievement.

The concept of the socioeconomic life cycle guided the construction of models. It suggests that family-background factors influence early achieved statuses, and these in turn influence later ones. This scheme can be represented either by an arrow-diagram or by a set of linear equations.

An incremental strategy of model building dictates efforts to enlarge upon the basic model with which the research began by including (1) additional background factors, (2) new intervening variables, (3) a variety of career contingencies, and (4) ultimate outcomes of the process in addition to the one given primary emphasis (occupational status).

All the models presented here serve to convey interpretations of data that are regarded as tentative. There is every reason to expect further improvements and elaborations of all the models.

Methods and Models (Chapter 2). Much of the work reported here was carried out by the technique of path analysis. The causal diagram or equivalent set of linear equations that represents the assumed scheme of direct and indirect influences holding among a set of variables can be used to infer equations that are to be solved for the values of unknown path coefficients. The coefficients indicate the relative strength of the determinants of specified dependent variables. In a recursive model, there is a sequence of dependent variables as well as a set of predetermined variables taken as antecedent to all the dependent variables.

The reduced form of a model is obtained upon eliminating one or more of the dependent variables intermediate between the predetermined variables and the dependent variable of interest at the moment. The full model and its reduced form are equally valid representations of the process under analysis. The former makes explicit the "mechanisms" of influence that are only implicit in the latter. With respect to its reduced form, the full model may be regarded as an "extended" model.

A confusing variety of correlation and regression statistics are in use in sociological research on the topics studied here. The choice of the appropriate statistics and the placing of a correct interpretation on them are facilitated by the adoption of the methodological approach exemplified in this project.

Sources of Data (Chapter 3). Research will become truly cumulative only when different studies use common specifications of populations and standardized techniques of measurement. In this project we sought bodies of data as nearly comparable as possible with our basic data from the 1962 survey of "Occupational Changes in a Generation" (OCG). Some six major sets of data from other large-scale investigations were obtained and subjected to secondary analysis. In addition, a number of items of lesser scope were gleaned from other sources for use in particular analyses. In all cases, we were concerned to bring the borrowed data to bear upon the specific objectives of this project rather than to accomplish a comprehensive summary.

The Basic Model (Chapter 4). The basic model derives from research using the OCG data. The version of it presented here represents educational attainment as depending on three family-background factors--father's education, father's occupation, and number of siblings. Occupational status is taken to depend on education and the three family characteristics. Income is taken to depend on the two prior achievements (occupation and education) and on the three family-background factors. Estimates of the coefficients in this basic model are given for four age groups; there is great similarity in the four sets of estimates.

A close replication is obtained when 1966 Detroit data are used to estimate coefficients in the basic model. This same set of data affords an opportunity to compare results using, alternatively, an occupational prestige score and an occupational socioeconomic index as the measure of occupational achievement. The results suggest that the latter is for present purposes the preferable measure; it is used in most of the remainder of the study.

Background Variables (Chapter 5). In the native white population, national origin (father's country of birth) is not a major factor in occupational achievement. Only two origin groups show substantial departures from the average: U.S.S.R. origin is favorable and Latin-American origin unfavorable to achievement, when national origin groups are equated for family-background factors. In both cases origin operates via education as well as directly.

Like the Latin-American minority, Negro Americans are disadvantaged both by the low status of their families of orientation and by handicaps to educational and occupational achievement superimposed upon the family factors. The impediments are especially severe for Negroes. Only about one-fourth of the income gap between Negro and white men can be attributed to the three family characteristics in the basic model (head's education and occupation, and family size). Other major components are due to educational discrimination (unequal education attained by men with equivalent family backgrounds), occupational discrimination (unequal occupational achievement for men with equivalent education and family backgrounds), and economic discrimination (unequal earnings for men in the same kinds of occupations, with the same number of years of schooling, and with equivalent family backgrounds).

Number of siblings is, in the basic model as well as in extended models presented later, a consistently negative influence on occupational achievement. It operates mainly via its depressing effect on educational attainment. The effect is equally apparent when either number of brothers or number of sisters is considered. Inasmuch as the sex composition of the sibship seems irrelevant, it suffices to accept total number of siblings as the measure of size of family of orientation.

Rearing in a broken family (headed by a female) is somewhat unfavorable for occupational achievement for both Negroes and whites. Contrary to the import of some discussion on this topic, however, family stability is not a major factor in the explanation of racial differences in occupational success.

Intelligence (Chapter 6). Although it is not commonly defined in that way, there is a good argument for thinking of intelligence as "ability to perform occupational roles." That the pioneers in the measurement of intelligence implicitly proceeded on some such notion is suggested by the very high correlation between the "intelligence demands" of various occupations, as estimated in the Barr scale, and the "prestige" of those occupations as reflected in ratings by the general public. Despite this high correlation, it remains empirically contingent whether particular individuals will find their way into occupations of varying status to a greater or lesser degree on the basis of the kinds of abilities reflected in measurements of intelligence.

Some significant bodies of published data provide estimates of the correlation of parental occupational status with measured intelligence, the correlation of intelligence measured in childhood with subsequent educational attainment, and the correlation of mental test scores of young men with occupations held at an early stage of the career. With appropriate caution, such estimates may be juxtaposed with other data available to the project in the construction of models explicating the role of ability in achievement.

Preliminary versions of this kind of model make it clear that, while intelligence has a substantial influence on amount of schooling,

it does not fully explain the correlation of family-background factors with schooling. Moreover, a very substantial correlation between the levels of schooling of brothers can only partly be explained by common family-background factors and sibling resemblance in intelligence.

The work leading to a "final model" of ability and achievement takes explicit account of the possibility that intelligence measured at maturity may be partly a result of amount of schooling. What appears to be an appropriate adjustment for this effect, however, leaves intact the proposition that intelligence has a substantial influence on occupational achievement, apart from its correlation with family-background factors. Much of that influence, however, is mediated by educational attainment. While the inclusion of intelligence test scores in a model of the process of achievement, therefore, increases appreciably the proportion of variation in occupational status "explained," there remains a very substantial amount of variation still "unexplained."

Aspirations and Motives (Chapter 7). A wide variety of concepts and approaches to measurement can be subsumed under the heading of "dispositions." We have not sought to adjudicate conceptual issues, but rather to point up some problems in measuring dispositions and in interpreting the results of such measurement in the light of hypotheses concerning their operation.

Both occupational "aspirations" and occupational "plans" are correlated with family background. The slope of the regression on father's occupational status is higher, however, to the extent that the stimulus question emphasizes realistic prospects (as against fantasies or desires) for occupational achievement. With such an emphasis, the slope of occupational "plans" on father's status is about the same as the slope of actual achievement on father's status. However, the mean level of aspirations is higher than the mean level of achievement. This suggests that, despite pervasive intergenerational upward mobility, many men fall short of realizing the aspirations of their youth.

Educational "plans" can be reported rather realistically when the questions designed to elicit them are appropriately phrased. Nonetheless, one can entertain the hypothesis that at any given time not all respondents will have made plans that are equally well crystallized. Hence, "plans" as measured may be interpreted as an indicator of "latent decision" to pursue further education. On this interpretation, very little influence of family background carries over into a direct effect on educational attainment, for the hypothetical construct, "latent decision," can be so formulated as to take background factors fully into account.

Use of a projective test to infer level of achievement motivation has been strongly advocated, and the well-known study of Crockett (1962) used achievement motivation so measured as an independent variable influencing occupational mobility. We re-worked Crockett's material to accomplish two things: (1) to render the coding of occupations in

his material comparable to that used in the remainder of this project; and (2) to put the relevant variables into a format suited to the type of model developed here. When this is done, we find that the projective measure of need achievement has a significant association with achieved occupational status, to that extent supporting Crockett's original conclusion. However, inasmuch as this measure is negatively correlated with father's occupation (though perhaps not significantly so) the need-achievement score does not turn out to be an especially informative intervening variable. Its inclusion in a model does not help to explain the intergenerational correlation of occupational statuses.

In research on social processes operating in real human populations we shall often, if not always, be in the position of inferring motives from one or another kind of indicator, rather than measuring them directly. In this event, we must make explicit the conceptual scheme upon which the inference rests as well as that containing the hypotheses concerning how motives operate. One of our most elaborately constructed models provides a paradigm for the problem in which it must be assumed that the indicators of motivational factors are contaminated by the very outcomes that the motives presumably help to explain. On certain postulates about how the contamination is effected, it becomes possible to derive rigorously an interpretation that departs in several significant particulars from one that merely interprets indicators naively. While this particular exercise is perhaps most interesting for its suggestions about method, it does lead to the suggestion that motives which are positively intercorrelated may nonetheless have opposing influences on achievement outcomes.

The project had access to only one body of longitudinal data including indicators of motivation (if educational and occupational aspirations are so interpreted) measured at a time well before the achievements they presumably influenced. We explored the consequences of postulating an unobserved motivational factor underlying the expressed aspirations. One model developed along these lines suggested that motivation as crystallized by late adolescence is indeed a significant factor intervening between family socioeconomic background and intelligence, on the one hand, and occupational achievement, on the other. The two prior factors, nevertheless, appear to retain significant direct (unmediated) effects; and inclusion of the motivational factor in the causal scheme did not result by any means in an approach to complete "explanation" of the outcome.

A final exercise in the interpretation of indicators of motivation led to a model with interesting properties. Among other things the data used comprise the only set including both a measure of intelligence and some indicators of motivation. It was shown that the data are consistent with--that is, they cannot be used to disprove--an interpretation that treats underlying but unobserved motivational factors as relatively important determinants of occupational achievement. At the same time, the model does not begin to approximate a "complete explanation" of achievement. Moreover, the attribution of considerable importance to

motivational factors is carried through consistently only by the simultaneous acceptance of the assumption that the available indicators of motives are exceedingly fallible.

Social Influences (Chapter 8). Wives, parents, friends, and schoolmates are among the significant others whose influence on occupational ambitions and choices has frequently been emphasized. We looked first at the proposition that wives may or may not spur their husbands to occupational achievement and may thereby introduce variance into occupational outcomes that is substantial and independent of other measured factors affecting these outcomes. The answer obtained, in conformity with the findings of previous research, is that the proposition holds to only a very slight degree. We next considered the wife as mother, inquiring whether the data available to us shed light on the extent to which the socioeconomic characteristics, intelligence, and personality traits of mothers influence the aspirations they form for their children. It may perhaps be regarded as disappointing that only 5.7 per cent of the variance in mothers' aspirations for children's college education can be attributed to such factors. The measurements are, however, on mothers of very young children.

Another body of data can be juxtaposed with the preceding set to construct a model representing the hypothesis that parents' aspirations are crystallized under the influence of the child's own ability, as it becomes manifested in his performance in school. The interpretation illustrates how rigorous inferences can sometimes be made when an explicit model is proposed to reconcile apparent discrepancies between results from different studies. The interpretation remains, of course, conjectural; but the conjectures are rather more carefully disciplined than is usually the case.

Perhaps the most elaborate model constructed in this project concerns the hypothesis that in a pair of friends each influences the development of the other's educational and occupational ambitions. The peer effect had been detected in previous research; here we were concerned to estimate its relative weight in a comprehensive model of the development of aspirations. The significant feature of the model is that it allows reciprocal influences. Such a feature gives rise to rather formidable problems of identification and estimation of parameters. But the process of solving these is instructive in itself. The exercise in question may be considered a demonstration of the potential power and scope of the kinds of models proposed here.

In the discussion of "school effects," emphasis is placed on the initial partitioning of variance of both independent and dependent variables into within-school and between-school components. The latter may seem surprisingly small, in view of the considerable emphasis on "school effects" in earlier writing. A systematic exploitation of the analysis-of-covariance perspective, moreover, indicates the possibility that "school effects" are in considerable measure only the reflection of differential school composition on variables operating at the individual

level. The models exhibited in this part of the chapter illustrate how this perspective can be exploited in the context of path analysis and how the "peer effects" noted earlier can be imbedded in a model relating to "school effects."

Career Contingencies (Chapter 9). The occupational level at which a man begins his career is substantially predictive of the level at which he will be found at any age between 25 and 64. Moreover, first jobs and current jobs depend on background factors in much the same way and to much the same degree in the OCG data for four cohorts of men. Results based on these data cannot be reconciled completely with the hypothesis of a synthetic cohort, to wit, that observations on four age groups represent the pattern of successive measurements on a single cohort.

Detailed cross-classification of data on educational attainment by age at first job suggests that many men interrupt schooling to enter the labor force in what they will later interpret to have been their "first jobs." It is, therefore, an oversimplification to think of schooling as uniformly preceding first job. Men whose schooling was interrupted by the beginning of work are unfavorably selected on background characteristics, as compared with men attaining the same ultimate educational level without such an interruption. It is for the latter men, in particular, that level of first job is strongly correlated with subsequent level of occupational achievement.

A third career contingency, migration between attainment of age 16 and the 1962 survey date, involves comparisons of populations in communities of varying sizes, distinguishing among nonmigrants, migrants to these communities with nonfarm background, and migrants with farm background. The pattern of mean occupation scores in each size-of-place category clearly favors the nonfarm migrants by comparison with the "natives," and the "natives" by comparison with the farm migrants. The advantage of the nonfarm migrants is slightly reduced when we take account of their superior family backgrounds, that is, the selective factor in migration. The disadvantage of farm migrants is markedly reduced by the same procedure; indeed, with standardization for family background, the farm migrants are found to be approximately equal to nonfarm migrants in occupational achievement and, therefore, superior to nonmigrants. Thus, migration per se is a favorable augury for occupational success, although the methods and data employed here do not permit a decision between alternative hypotheses that may be suggested to explain the observed effects. Migrants may be selected for favorable personality traits, like ambition or persistence; or, on the other hand, migration may in itself provide access to favorable opportunities for occupational advancement.

Treatment of the disruption of marriage as a career contingency is handicapped by lack of information on the timing of events in the cycle of family formation and dissolution. Nevertheless, there is a measurable difference in occupational status between men with intact

marriages and those whose classification as of the survey date is divorced or separated. No more than half of this difference is accounted for by measured characteristics of family background, educational attainment, and status of first job. Maintenance of the marriage, therefore, is presumed to be a favorable factor.

Size of family of procreation, or marital fertility, has usually been observed to correlate negatively with measures of achieved socioeconomic status. These observations are here confirmed. However, it appears that in a multiple-variable model there is a positive coefficient for the regression of income on fertility, once occupational level and educational attainment are taken into account. The interpretation of this result is hazardous, since results of this kind may ensue from essentially artificial consequences of high collinearity among status variables. There is, nevertheless, some plausibility in the argument that men with many children are constrained to seek jobs that enhance their incomes, even at the expense of a sacrifice of occupational prestige. It has been observed, moreover, that multiple jobholding (a factor not measured in our data) is more common among men with large numbers of children. This would be reflected in higher incomes, relative to the status of the primary job.

The final career contingency concerns the timing of fertility rather than the cumulative size of family. Specifically, occupational status is found to relate in a curvilinear way to the length of the interval from marriage to birth of the first child. Short intervals are distinctly unfavorable, the optimum interval is around three years, and longer intervals are again unfavorable. A significant part of this relationship is explained by the unfavorable selection on family background characteristics for short intervals, and an even more substantial part by the correlation of birth interval with educational attainment and level of first job. However, the persistence of a residual effect of length of interval on occupational status, holding constant all these prior variables, argues that childspacing is indeed a significant (though by no means major) career contingency.

Conclusions (Chapter 10). The report presents numerous examples attesting to the feasibility of our research strategy. Further fruitful developments employing a similar strategy may be expected, even if in the longer run a more or less drastic alteration of it will be required by improvements in measurement technique, the accumulation of knowledge, the formulation of more complex hypotheses, and the invention of different kinds of models.



## CHAPTER 1

### FRAMEWORK AND STRATEGY

Two complementary processes interact to produce a growth of knowledge in an area subjected to continuous scientific inquiry. The first is the process of discovery and verification: the establishment of facts and relationships via observation, analysis, and the replication thereof. The second is the process of systematization or synthesis, which eventuates in interpretation and generalization. Here, facts are assimilated to conceptual and explanatory schemes, resulting in the enlargement and specification of the latter. In the undertaking described in this report the preponderant emphasis has been on this second process. Although some new findings are reported and some familiar ones are re-tested, the primary objective throughout the project was to achieve an improved synthesis of an existing body of knowledge.

Occupational achievement has been subjected to study from a variety of viewpoints and there is a substantial store of information relating patterns of achievement to many different factors and variables. While promising efforts at synthesis have been ventured from several points of view, it seemed plausible in the light of recent progress in techniques of model construction in sociology to suppose that another such effort would be profitable.

To interpret consistently or to systematize cogently a collection of findings and facts requires the adoption of a point of view. The framework within which synthesis is attempted implies criteria for selection of data, so that the outcome is something quite different from a compendium or comprehensive survey. The typical product of the kind of synthesis attempted here will be referred to as a "model." This usage has the merit of continuously re-emphasizing the purposeful selectivity entailed in the arrangement and manipulation of data. The purpose is not to construct a faithful portrait of reality, but rather to exhibit and rationalize some of the suspected connections between aspects of reality. If the metaphor is allowed, one can describe the spirit of the investigation by saying that its intention is to develop a special-purpose map of the terrain rather than to provide an aerial photograph of it. More than one such map, obviously, could represent the same terrain, depending on the purpose. In this presentation, little effort will be made to justify the purpose, for it is one that is shared, apparently, by a substantial number of investigators. If any significant progress is made in assaying the import of the kind of work they do, the enterprise will have served its purpose.

### 1.1. The Process of Achievement

Students of social stratification are interested in jobs and occupations primarily as labels or indicators of social status. The acceptable performance of an occupational role confers upon the incumbent of that role a status which, to a rough approximation, is somewhat uniformly evaluated by most members of the society (Reiss and others, 1961). In addition to the more or less direct status reward associated with an occupation, other rewards and status evaluations are linked to occupation in a variety of ways. Most obvious is the fact that pursuit of an occupation leads to remuneration in the form of earnings, which in turn may be used for consumption and investment in forms that represent utilities to the earner himself and indications of status to his associates.

In the United States, as in other contemporary industrial societies, occupation is typically an achieved status (as contrasted with such an ascribed status as membership in a recognized ethnic group). That is, the conferment of status is based in some considerable measure on the role incumbent's own performance of the role rather than upon any one of a number of extrinsic considerations, such as his family's reputation or his personal attractiveness. To be sure, there is an interaction among criteria of status and it can frequently happen that role performance is facilitated or impaired by various "extrinsic" factors or that status evaluations are "contaminated." Thus one often observes instances of incompetent performance of occupational duties where the incumbent is insulated from the normal consequences of incompetence by his tenure of certain nonoccupational statuses. Hence the statement that occupation is an achieved status is not equivalent to the statement that occupational roles are allocated to persons solely on the criterion of "merit." Indeed, the main empirical question in the study of status achievement (of which occupational achievement is an important example) is whether and to what degree such achievement depends on factors other than the individual's competence and inclination to perform the role on the basis of which status is conferred. The corollary question then becomes that of the extent to which "competence and inclination" themselves depend on factors other than the role incumbent's own capacity or prior achievement.

The problem suggested by the title, "socioeconomic background and occupational achievement," can therefore be stated as follows. Given that occupation is an achieved status, what factors can be identified as influencing this achievement and thus as accounting for variation in occupational status? In particular, what if anything about socioeconomic backgrounds represent favorable or unfavorable conditions for achievement, and how do these conditions exercise their influence?

It is often observed, for example, that an appreciable number of men are found in the same occupations as their fathers pursued. Even "occupational inheritance," when it is observed, is not an exception to the principle that occupation is an achieved status. It may well be

easier for a farmer's son to become a farmer than it is for the son of a nonfarm worker; but to hold the status of farmer he is required actually to perform that occupational role in at least some minimum degree. By the same token, a doctor's son becomes a physician, not by some immediate mechanism of "inheritance" but by going to medical school and carrying on a medical practice, however much his father's prior achievements may facilitate his own. Just as it is easier for a doctor's son to become a doctor than it is for a plumber's son, it is easier for a doctor's son to become a lawyer than it is for the son of a truck driver. The operation of "occupational inheritance" is merely a special instance of the general phenomenon that the socioeconomic background of a high-status family of orientation is favorable to the achievement of high occupational status.

But the connection between socioeconomic background and occupational achievement is neither perfect nor unproblematic. Indeed, in one sense, the most important parameter of the process of stratification in a society is the degree of association between background, or social origins, and achievement (Svalastoga, 1965, p. 70). Moreover, the existence of such an association, of whatever degree, is not self-explanatory. Presumably it comes about through the operation of one or more mechanisms that produce the observed result. If it is the case, for example, that occupational roles are allocated to a substantial degree on the basis of educational attainment; and if it is true, in turn, that amount of schooling depends in some measure on the status level of the family of orientation, then one would have a good basis for the argument that differential educational attainment is one of the "mechanisms" via which background influences occupational achievement. Of course, this particular mechanism might operate in combination with other mechanisms. Moreover, one might take the very relationship between educational attainment and background as problematic and inquire what mechanism accounts for this relationship. Do children from families differing in status also differ in scholastic aptitude, which in turn affects the amount of schooling received? Or is it the case that the amount of resources a family may invest in the schooling of offspring is sharply limited by its status level, so that an economic mechanism is of prime importance?

As these cursory examples should suggest, there is no clearly specified terminus to the search for "mechanisms" which account for observed relationships and thereby explain the parameters of a process. As the search is pressed, if it is successful, the account of the process becomes more and more detailed and models of it become more complicated. All the work done to date would appear to be at a comparatively early stage in such a search and we are really only at the very beginning of what may turn out to be a long sequence of substituting new and more elaborate models for old and less informative ones. Whether the sequence has a limit at which curiosity might come to rest is hardly an issue that must be resolved at this time.

## 1.2. The Socioeconomic Life Cycle

Implicit in the foregoing introductory remarks is a commitment to the strategy of looking at what happens to an individual over a substantial part of his life time--or, since our concern is really with populations of individuals, what happens to a cohort of men as they move through an appreciable part of their life cycles. The previous discussion has not only served to introduce the life cycle approach, but it has indicated the rudiments of a framework that suggests how to identify some strategic observations on the course of the life cycle. As has been implied, we might think of at least three "stages" of the socioeconomic life cycle, conveniently labelled family, schooling, and job. Concerning family, we clearly want to ascertain the statuses of the families of orientation represented in a cohort of men. Second, concerning schooling, we must ascertain how the men in the cohort vary with respect to the amount of education they ultimately secure. Finally, concerning job, we must find out how they are placed in the structure of occupational statuses. With only this amount of information, a beginning can be made in contriving some significant measurements of the process of achievement and in interpreting the relationships established via such measurements. Despite the apparent simplicity of this conceptual framework, it is worth noting that it has become clearly articulated only within recent years (Duncan and Hodge, 1963) and that something approximating adequate measurements on a representative national sample became available only within the last five years (Blau and Duncan, 1967). These accomplishments of previous research represent the starting point of the investigations reported here.

Some significant decisions entailed in the formulation of a research strategy can be elucidated illustratively even if, for the moment, we confine our attention to the very rudimentary model: family → schooling → job. Estimation of parameters and assessment of relationships within this model presuppose the capability of measuring the variables taken to represent the relevant condition or status at each of these stages.

Let us consider first the matter of the status of the job held at some convenient point in the life cycle. Assuming that job titles or occupational designations are available for a cross section of the men in a given cohort or set of adjacent cohorts, we have a large number of options as to the ways in which the jobs may be classified or characterized. Most relevant for the problem considered in this research, as stated above, are indexes of occupational prestige and occupational socioeconomic status. We may take advantage of the rather considerable amount of prior work which has resulted in the construction and validation of standardized measures of these two aspects of occupational differentiation (Reiss and others, 1961; Hodge and others, 1964). Among other things, this work has demonstrated a close correlation between occupational prestige and occupational socioeconomic status, although the two variables are not quite interchangeable. (The present project sheds some additional light on this matter.) Using either type of

index, occupational achievement may be indexed by a quantitative score that has convenient properties for statistical analysis and model construction.

The measurement of schooling can be carried out even more expeditiously. In most of the work described in this report, educational attainment is simply indexed by the number of years (grades) of school completed in the formal educational system. While refinements of this measure have been suggested, none can be considered fully operational at this time. Moreover, it is by no means certain that the gain in precision from such refinement will be worth the effort entailed in effecting it.

As for the initial stage of the model, "family," the obvious first step is to measure the socioeconomic level of the family of orientation in the same way that the individual's own achieved status is measured. Thus, primary emphasis has been placed on the educational attainment and occupational status of the head of the family in which a man is reared, the measures of these two variables being the same as those already mentioned. Obviously, these two measures comprise only a minimal selection from the set of conceivable indexes of "socioeconomic background," although there is reason to believe that they tap much of the variance associated with such alternative or additional measures as family income and mother's education. Even a comprehensive roster of such socioeconomic indexes, however, would not exhaust the connotations of "family" as an initial stage in the socioeconomic life cycle. No doubt we still have much to learn about the traits and conditions of families that have an influence on the achievement of their children, although it is already possible to demonstrate the significance of family size and the racial or ethnic classification of the family, even though these are not statistically independent of its socioeconomic level.

Apart from bringing up the issue of the choice of variables, the rudimentary version of the model forces one to give explicit attention to the manner in which the process of achievement is to be represented. As already stated, the model posits a statistical dependence of schooling on family background, and a subsequent dependence of occupational achievement on schooling. Thus schooling is regarded as an intervening or intermediate variable which may operate to transmit the influence of family background on occupational achievement. But two other logical possibilities must also be reckoned with. First, schooling may operate not only as a mechanism transmitting the influence of the prior stage, but it may contribute variance to the outcome that is independent of that stage. Second, even though most of the effect of family background on occupational achievement is transmitted via schooling, some of it may be transmitted in some other way. As long as we stay within the confines of the model under discussion, we must acknowledge the possibility of direct effects of background on achievement as well as the indirect effects via schooling.

Despite the rudimentary nature of the system of relationships discussed thus far, it clearly is one of sufficient complexity that strictly verbal description of it threatens to become excessively cumbersome. Therefore, at this point, it is advisable to introduce the two other modes of representing such a system that will be employed throughout this report, the diagrammatic and the algebraic.

Figure 1.2.1 exhibits a diagrammatic arrangement of the variables discussed thus far as being implicated in a rudimentary model of the process of achievement. At the far right, as the ultimate outcome of the whole process, is respondent's occupation. The letter Y stands for the variable, occupational socioeconomic status, as measured on the scale developed by Duncan (1961a). Four arrows lead to Y, representing the assumption that occupational status depends (directly) on educational attainment (measured by years of schooling, U), on family head's occupation (measured on the socioeconomic scale, X), on family head's education (years of schooling, V), and on unspecified residual factors summed up in variable B, which is taken to be uncorrelated with the other three determinants of Y. The second relation depicted by the diagram is the dependence of educational attainment (U) on family head's occupation (X) and family head's education (V) as well as unspecified residual factors, summed up in variable A, taken to be uncorrelated with X and V.

The system we are discussing thus has two dependent variables or outcomes, respondent's education and his occupational status. Each of these is taken to be completely determined by factors recognized in the model. The assumption of complete determination is rendered tenable by the introduction of the variables A and B, which are the "residual factors" influencing U and Y, respectively. The implications of this assumption will become clearer in Chapter 2, where the conventions appropriate to this mode of diagrammatic representation are spelled out more fully. At this point, only one further word of explanation is needed. The arrows leading from one variable to another (except in the case of the curved line with arrowheads at both ends) symbolize the notion of direct dependence. If we assume that dependence is transitive, then the pattern of arrows also conveys information about the way in which indirect dependence is assumed to operate in the model. Thus if Y depends on U and U in turn depends on A, then Y depends indirectly (though not directly, on the assumptions of this model) on A. Moreover, since Y depends on U and U depends on X, then Y depends indirectly on X as well as directly; and the same may be said in regard to the dependence of Y on V: both direct and indirect dependence are involved. Indirect dependence is ascertained from the diagram, therefore, by reading back along a compound path of connecting arrows.

We shall use interchangeably such terms as "depends on," "is caused by," and "is influenced by." At all times, statements about the "causes" of a variable will refer to the particular model under discussion and are not intended to have any special ontological validity with respect to the real world. That is, if we say that Y is caused by (influenced by, depends on) U, X, V, and B, we mean that we are

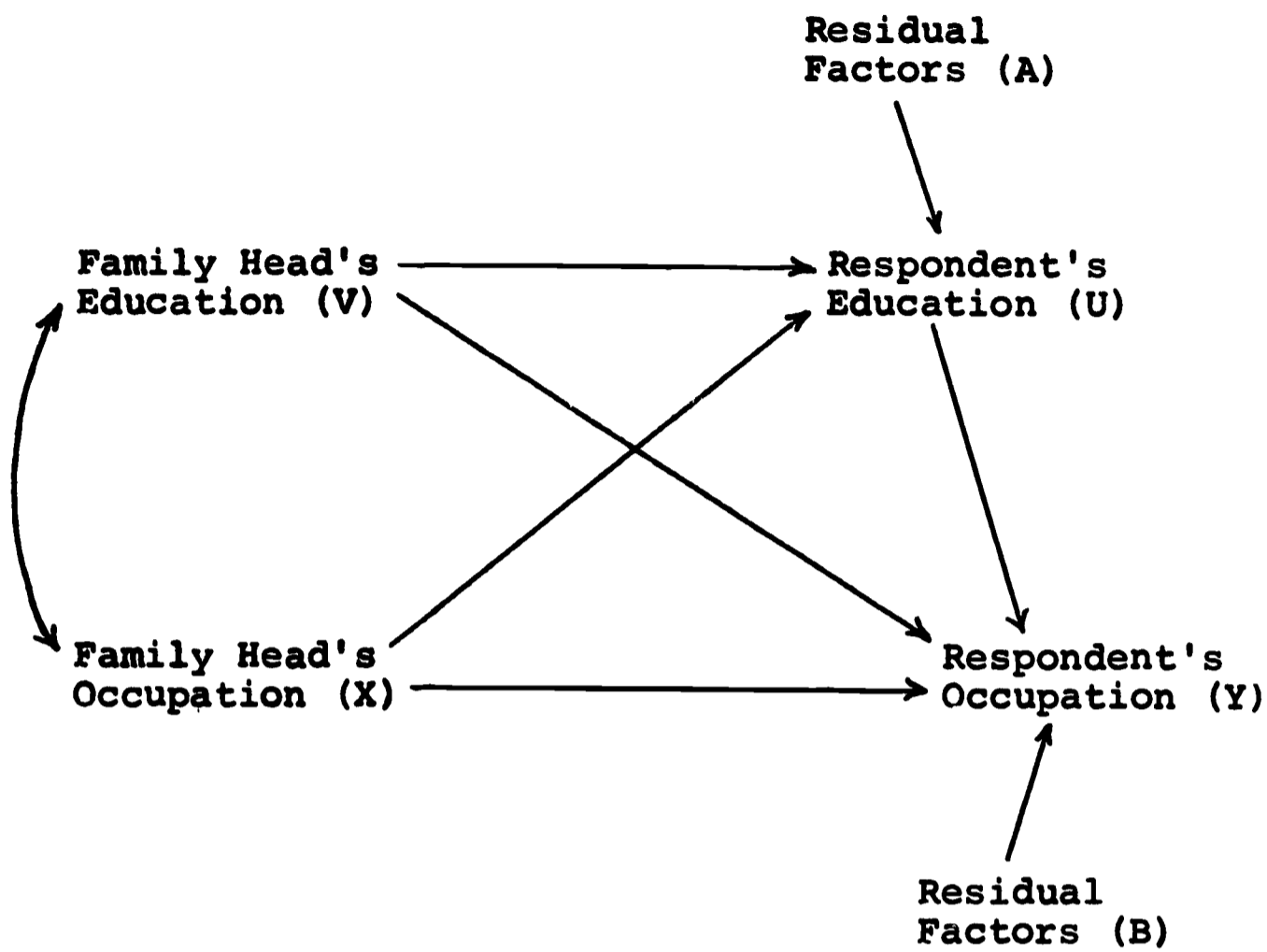

Figure 1.2.1.--Schematic Representation of the Basic Model of Occupational Achievement.

considering a model that represents a process assumed to work in this fashion. Such statements about the properties of the model are to be sharply, clearly, and consistently distinguished from statements about the validity or suitability of the model as a representation of what is actually "true" about external reality.

An alternative, but completely equivalent presentation of the model depicted in Figure 1.2.1 can be stated as a set of two equations (in which the symbols have the same meaning as in the figure):

$$Y = p_{YU}U + p_{YX}X + p_{YV}V + p_{YB}B$$

$$U = p_{UX}X + p_{UV}V + p_{UA}A$$

To these equations must be added the specification that residual A is uncorrelated with variables X and V and that residual B is uncorrelated with variables U, X and V and with residual A. The coefficients symbolized by p's correspond to the straight lines bearing arrowheads in the diagram. The algebraic presentation makes it explicit that the model is a system of linear equations. Thus the algebraic translation of "U depends on X, V, and A" is "U is equated to a linear combination of the values of X, V, and A."

### 1.3. Incremental Strategy of Model Building

Thus far it has been indicated (a) that the study of the process of achievement will be effected by taking the socioeconomic life cycle as a conceptual framework; and (b) that it is possible to translate assumptions about how the process operates into an explicit model which can either be represented by a diagram in which causal relationships are symbolized by arrows linking variables or expressed algebraically as a system of linear equations. The example given of such a model is the somewhat rudimentary one that we shall term, for convenience, the "basic" model of this research. The model is "basic" only in the sense that it represented the point of departure for the project, the intention of which was to develop "extensions" of it. The nature of the extensions that were attempted is the subject of the present section.

A good model serves not only to rationalize and interpret a pattern of empirical relationships but also to raise questions whose answers require further empirical inquiry and/or modifications of the model. Thus the long-run course of research in an area of inquiry may be guided, more or less explicitly, by an incremental strategy of model building. The history of previous work in the area of socioeconomic achievement becomes more intelligible on the assumption that this strategy was implicit in the collective efforts of research workers.

For a long time, investigators were preoccupied with the problem of "occupational mobility"; their basic concern, in effect, was to establish the nature and degree of relationship between respondent's and



father's occupations (Y and X, in the notation introduced above). Once reasonably reliable estimates of this relationship were in hand, it was natural to inquire into its mechanisms. At that point, it was suggested that schooling is an important intervening variable. Studies of occupational mobility, such as those of Glass (1954), Carlsson (1958), and Svalastoga (1959), began to include attention to this variable, and it became pertinent to suggest a simple three-variable model treating schooling as dependent upon father's occupation, and son's occupation as dependent upon both schooling and father's occupation (Duncan and Hodge, 1963). Once this model was available and its properties had been explored, one logical next step was to incorporate into it an additional measure of social origin, to wit, father's education, on the supposition that schooling might depend on more than one aspect of family background. Such was the genesis of the basic model outlined in the previous section, which was treated in some detail in the research of Blau and Duncan (1967).

As the strategy of model building became more explicit, it was evident that further progress need not be limited to the consideration of one additional variable at a time. Moreover, the tradition of studies emanating from the original interest in occupational mobility was seen to be converging with that of investigators concerned with such variables as educational plans and occupational aspirations (e.g., Turner, 1964; Sewell and Orenstein, 1965) and those considering the role of psychological variables in the process of achievement (e.g., Centers, 1948; Kahl, 1965; Stacey, 1965; Crockett, 1966). The hunch that it would be fruitful to attempt a merging of these lines of investigation underlay the proposal to attempt a whole series of "extensions" of the "basic" model. A review of the literature provided suggestions for the kinds of variables to be considered in such an endeavor and leads for locating pertinent bodies of data.

After even a cursory examination of the basic model, the student of social stratification and occupational achievement will have no difficulty in suggesting ways in which it might be extended. Our intention was not to generate an exhaustive list of such hypothetical extensions but to attempt seriously to effect some significant number of them.

To begin with, it seemed desirable to consider enlarging the number of background variables. It was mentioned in section 1.2 that the two measures of the family's socioeconomic level (head's education and occupation) hardly exhaust the list of possibly relevant variables of this kind. Yet, there was reason to believe that substantial marginal improvement of the model would not be achieved merely by including more of this particular kind of variables; hence this task was not given high priority. Instead, attention was focussed on other kinds of measures pertaining to the family or deriving from the use of "family" as an initial stage of the socioeconomic life cycle. One obvious candidate, in view of its demonstrated association with educational attainment (B. Duncan, 1967), is family size, or number of siblings.

Another kind of background variable is suggested by the fact that belonging to a given family of orientation confers ascriptively the status of member of the ethnic category into which that family is socially classified. Hence, race and ethnic classifications are taken to be potentially significant "background" variables. Much the same could be said of religious (denominational) group membership, which tends to be an ascribed status, although by no means an entirely fixed one. Little or no attention was given this factor in the present project, however, primarily for lack of readily available data. Fortunately, the dissertation of Bruce L. Warren (see Appendix A) will involve a thorough analysis of the religious factor within a framework closely related to the one used here.

Two other important initial conditions of achievement are linked up with membership in a family of orientation. These are the individual's locations in time and space. His location in time is irrevocably fixed by his date of birth; and, from some standpoints, of all the advantages or handicaps conferred on the offspring by the parents few are more important than those depending on the historical period within which life is to be lived. It will not be expeditious to treat location in time as a "background factor" in quite the same sense as family size or socioeconomic status; but the importance of this factor dictates a continuous attention to the historical dating of information and the age classification of respondents. As for location in space, certain regional differences in achievement are well known. A more extensive treatment of the implications of such differences would have been entirely appropriate, but it turned out to be impossible to improve much on the results of earlier work (Blau and Duncan, 1967, Chapter 6).

A most interesting category of variables comprises those we shall term intervening variables. The import of this term can be explicated by referring back to the basic model. That model, if it be accepted as a rough first approximation, discloses a substantial connection between occupational achievement and socioeconomic background and also a similarly substantial one between educational attainment and background. As already suggested, we may regard the amount of schooling secured as a factor that intervenes between background and occupational achievement, operating both to transmit part of the influence of background and also to induce variance in achievement not associated with background. Educational attainment, therefore, is our first example of an intervening variable. It qualifies as such by virtue of two properties: first, schooling itself depends on antecedent variables in a causal sequence, and, second, it influences a variable (occupational achievement) taken to be an outcome of such a sequence. Both conditions are necessary for us to accept the interpretation that it is a significant intervening variable. From one point of view, much of the scientific quest is concerned with the search for intervening variables that will serve to interpret or explain gross associations presumed to reflect a causal relationship. (It is now believed by many investigators that the association between smoking and incidence of lung cancer is indeed generated by a causal sequence; but what is the intervening variable?)

Granted that education is one important intervening variable, the demonstration that this is so merely heightens one's curiosity about others. For one thing, the connection of education with background factors is, itself, not unproblematic. What variables are involved in the mechanism producing this causal relationship? Moreover, as we shall see, while education is indeed of great importance in transmitting the effect of background, there is in the basic model a nontrivial direct influence of background on occupational achievement. How does this come about? Can we introduce into the model intervening variables other than education such that the estimate of the direct influence of background shrinks to zero? In this event, the extended model could make a fair claim to have explained fully the association between background and occupational achievement.

In view of the central role of education in the basic model, an obvious candidate for another intervening variable is intelligence, for some differential psychologists now take the position that intelligence as measured by standard mental ability tests is essentially "scholastic aptitude." It will be of interest to learn whether, or to what extent, the influence of family on schooling operates via intelligence--or rather, it will be of interest to see what issues are raised by this manner of posing the question. Moreover, if intelligence influences achievement, it will be relevant to estimate how much of this influence operates via educational attainment and how much is independent of the factor of amount of schooling.

Along with ability, some social psychologists would name motivation as a prime candidate for an intervening variable. Indeed, it was at the end of a chapter entitled "Intelligence and Motivation" that Lipset and Bendix (1959, p. 259) suggested "that by merging the sociological and psychological approaches to the study of social mobility we may be able to advance the study of the mechanisms by which individuals and groups reach their positions in the stratification structure." No doubt these authors did not mean to imply that "ability" and "motivation" exhaust the list of psychological factors that represent significant intervening variables, even though from a commonsense point of view these may seem to comprise an adequate classification of such factors. In any event, the spirit of the present investigation is nicely characterized by the remark just quoted from Lipset and Bendix.

It is not within the scope of the present enterprise to achieve a taxonomy of "psychological factors" that will rigorously satisfy the theoretical criteria of a science of behavior. Thus, the elaboration of distinctions between and relationships among motives, goals, values, aspirations, dispositions, and the like is a task left to the social psychologist. Insofar as this kind of work in social psychology has influenced research on the process of achievement, it suggests the advisability of some attention to one axis of classification of such variables. On the one hand, as suggested by the term "motive," there may be postulated dispositions that are deep-seated, enduring, and diffuse and pervasive in their influence on behavior. At the opposite

extreme, as suggested by such terms as "plans" and "intentions," are dispositions that are comparatively specific and temporally localized in their influence. A generalized "need for achievement," illustrating the former, may, therefore, be conceived as underlying the more or less definite "occupational aspirations" of a youth or the even more specific set of intentions tapped by a question on "college plans." Both sorts of variable will be considered as candidates for incorporation into an extended model, within the rather severe limits placed on the inquiry by present techniques of measurement and available data. To the limited accomplishment of the present project in this area will be added the results of a more detailed study being undertaken in the dissertation of David L. Featherman (see Appendix A).

Another group of intervening variables may conveniently be labelled as "social influences." Here we have in mind the patterns of social interaction between an individual and relevant "others" in his social milieu that may influence his dispositions or direct his attention to opportunities. The family of orientation, already considered in terms of its relevance to background, is here thought of as providing specific role models and as moulding characteristic dispositions, both directly and indirectly. Further, we wish to subsume under this category the suspected impact of peer groups on the formation of occupational goals or tendencies relevant thereto, whether this impact is disclosed in dyadic relations with friends or in the patterns common to an entire category of peers (as in alleged influences of "school climate"). To temper expectations in regard to this whole category of variables, it had best be stated at the outset that treating them in the format of the present inquiry poses some severe methodological problems and the success of the venture is quite limited. Fortunately, one aspect of the investigation will be supplemented by an ambitious study of "school effects" in the dissertation of Robert M. Hauser (see Appendix A).

The next major class of variables to be discussed might well be regarded as a subclass of "intervening variables"; but it poses some issues sufficiently special that it is convenient to have a distinct label, to wit, career contingencies. Here we have in mind decisions taken or circumstances encountered in the course of the life cycle that may have significant bearing upon occupational outcomes. Such contingencies may be related both to background factors and to other intervening variables, and thus serve to mediate the influence of either of these on occupational achievement. From another point of view, the recognition of certain career contingencies may be tantamount to a proposal of a more detailed sequence of stages in the life cycle. The difficulty with this viewpoint is that the contingencies in question--those associated with entry into the labor market, selection of place of residence, initiation of a family of procreation, and liability to military service--do not arise in a fixed temporal order and different individuals may not encounter all of them in the same way.

In purely conceptual terms, there is no apparent limit on the number of career contingencies that might be fruitfully examined. Here,

as in the study of intervening variables, the operative limits on the inquiry are imposed by the availability of data. The project did, however, seek to consider (albeit in varying degrees of detail) the following contingencies: (1) age at first job; (2) the occupational level of the first job; (3) residential migration; (4) marital status; and (5) fertility, i.e., size and timing of increments to the family of procreation. Each of these has been implicated in the process of achievement by results of previous research. A further contingency, probably a good deal more important than its scanty treatment in previous research would suggest, is military service. This topic has been opened up by an important survey (Klassen, 1966); but, unfortunately, the present inquiry has not been in a position to follow up the leads developed there.

In addition to the general caveat that applies to all the work reported here--to the effect that all results are to be regarded as tentative--it must be stipulated that the work on career contingencies falls considerably short of what would be regarded as an adequate investigation. Our work on these topics is not only placed at the end of the report but was in fact undertaken toward the end of the project, under considerable pressure of time. If the data reported suggest something of the complexities of the issues at stake, the effort will not have been wasted.

The final class of variables to be incorporated in our models comprises the outcome variables. The principal one of these has already been identified as occupational status, whether measured by a socio-economic index or on an occupational prestige scale. Although concentration on this particular outcome is dictated by the primary goals of the study, it is not irrelevant to consider other outcomes that may equally well represent outputs of a process of achievement--most notably, income or earnings, to which we shall give passing attention. A whole series of further outcomes could also justifiably claim attention--for example, job satisfaction, feelings of economic or status security-insecurity, social class identification, and other measures of "subjective achievement." Our study of such variables has been quite restricted, again primarily for lack of clearly relevant data suited to manipulation within the framework of our models.

To be sure, we are considering outcomes other than those mentioned. Indeed, each intervening variable or career contingency in a model is to be conceived as an outcome of a process traced up to a given juncture in the life cycle. Educational attainment is perhaps the clearest example in our work of an achieved status which is both an outcome of the earlier phases of the life cycle and an intervening variable with respect to later phases. The very nature of the kind of model we shall be developing is that "outcomes" at one stage become "antecedents" with respect to a subsequent stage.

The reader may have noted the omission of a kind of variable that is often discussed in reports of research involving moderately

complicated designs, that is, so-called "control variables." The omission was not inadvertent, for we should wish to argue that there is no clearly describable role for "control variables" as such in the strategy of model building to be illustrated here. Upon inspection, variables proposed as "controls"--if, indeed, any clear role is predicated for them whatever--will be found to fall into one or another of the categories already proposed: background variables, intervening variables, career contingencies, or outcome variables. When a causal model has been made explicit, "control variables" will have been properly allocated to one of these functional slots.

It might seem that an exception would have to be made for the sort of "control variable" that specifies the population within which the process is assumed to operate. In the present research, for example, all the data examined pertain to males; so that one might wish to assert that sex has been "controlled" by disposing of one of the categories of the sex classification. Our strategy does indeed rest on the assumption that patterns of achievement for men and women are quite distinct: different variables may be relevant, or the same variables may have different weights. But we should want to claim that, in principle, models of the process of achievement could just as well be constructed for females as for males. Construction of such models in parallel would be tantamount to the recognition of sex as a "background factor," albeit one with especially pronounced interactions with the remaining variables in the models. Confining our work to relationships observable in the male population was merely a tactic to make the investigation manageable and does not represent an acknowledgment that this classification (or any other such classification that might be proposed in addition to those considered here) enjoys some special status as a "control variable." It would undoubtedly be all to the good if investigators would relinquish that term entirely, in favor of making more explicit and defensible the rationale on which "controls" are introduced in statistical analyses.

#### 1.4. Prospectus

This introductory chapter is intended to acquaint the reader with the questions raised for investigation and the general strategy for seeking answers. Specific problems relating to definition of variables, securing and manipulating data, and techniques of model construction are to be discussed more fully in subsequent chapters. In Chapter 2 we shall present at some length the essentials of the technique of path analysis, which is to be employed throughout the remainder of the study in explicating models and securing estimates of their parameters. Sources of data are described in Chapter 3. Properties of the basic model and estimates made on it are treated in Chapter 4, in preparation for the series of extensions to be considered in the remaining chapters, which review the work done on the project in regard to the several background variables, intervening variables, and career contingencies identified above.

This report does not cover all the work done in the course of the project. A number of topics, suited to separate treatment, were dealt with in papers that had been published, were in process of publication, or were being considered for publication at the time this report was written. These are listed in Appendix A as "Project Reports Prepared for Separate Publication." When there is occasion to cite one of these in the text, this will be done by the number appearing in that list, as, for example, (Report #5). The reader may consult these publications for details of topics treated only in summary fashion in this report.

If it were necessary to assume that the reader will approach the material in this report uncritically, a number of caveats would be in order. Without stating these in detail, may we simply assure him that all the work reported here, insofar as it involves interpretations of findings or postulates embodied in models, is regarded as tentative. In no case is it assumed that the last word has been said, and many of the models obviously do no more than suggest leads for more thorough investigations. Such investigations, when and if they are carried out, will assuredly render many of our interpretations doubtful. A high rate of obsolescence of models is devoutly to be desired, provided that the old ones are replaced by superior versions.

## CHAPTER 2

### METHODS AND MODELS

The preceding chapter was intended to indicate both the breadth and the narrowness of the problem accepted as the task of this project. It is a broad problem in the sense that a rather diverse set of variables has been designated as appropriate for study, and the general framework is one that is purportedly susceptible to more or less indefinite expansion to accommodate such a list of variables. The problem is greatly narrowed, however, by the resolution to exploit a single self-conscious strategy of model building. Thus, the project places rather stringent requirements on sets of observations or measurements in determining whether they shall be considered relevant to the task at hand. We have no way to make use of impressionistic evidence or scraps of data that cannot, even conjecturally, be tied in with our basic model in some formal, quantitative way. We accept the opportunity cost of being deprived of the benefits (if any) of attending to the immense lore surrounding our subject in order to realize the more tangible benefits that accrue from being able rigorously to manipulate bodies of systematic, quantitative information. (The justification of this strategy in terms of a general philosophy of science is beyond the scope of this report; the reader who is completely skeptical of the possibility of such justification may be well advised to read no further.)

The task of the present chapter is to provide the (not very formidable) mathematical and statistical rationale of our procedures of model construction and estimation. Chronologically, the first accomplishment of the project was, in fact, the preparation of an expository treatment of the technique of path analysis (Duncan, 1966), drawing primarily upon the publications of the inventor of the technique (Wright, 1960a, b, and literature cited therein). Some parts of that exposition are recapitulated here. Luckily, the major example selected for the purpose of illustrating the properties of models treated by means of path analysis was one that falls squarely within the substantive area of concern to this project.



### 2.1. A Recursive Model

All the discussion in this section will concern the model represented in Figure 2.1.1. This model is drawn from the work of Turner (1964). A particularly instructive feature of this example is that Turner himself had not presented the entirety of the model in a single connected account, and he had made no use of the technique of path analysis or of the type of diagrammatic representation illustrated here. Nevertheless, it is possible to show that the model is implicit in his verbal statement of hypotheses and relationships, even though the statistical manipulations that Turner reported are not the ones that are seen to be appropriate once the model is made explicit. He does, however, provide in scattered contexts (Turner, 1964, pp. 49 and 52, Tables 11, 17, and 20) the essential data for estimating all the path coefficients of the model, in the form of intercorrelations of the five variables identified in Figure 2.1.1.

The statements made by the author that appear to imply this particular model may be summarized quickly. At one point, Turner (1964, p. 17) states, "background affects ambition and ambition affects both IQ and class values; in addition . . . there is a lesser influence directly from background to class values, directly from background to IQ, and directly between IQ and class values." Elsewhere (pp. 54-61) he suggests that school socioeconomic rating operates in much the same fashion as (family) background. In discussing the relationship between the two-family background and school rating--Turner notes that "families may choose their place of residence," but also concedes that "by introducing neighborhood, we may only be measuring family background more precisely" (p. 61). In short, the author does not unequivocally postulate a causal ordering of these two variables with respect to each other; accordingly, the diagram inferred from his statements makes no commitment on this point either.

The model as formulated verbally and represented diagrammatically can also be rendered algebraically as a set of linear equations:

$$\left. \begin{aligned} X_3 &= p_{32}X_2 + p_{31}X_1 + p_{3u}X_u ; \\ X_4 &= p_{43}X_3 + p_{42}X_2 + p_{41}X_1 + p_{4v}X_v ; \text{ and} \\ X_5 &= p_{54}X_4 + p_{53}X_3 + p_{52}X_2 + p_{51}X_1 + p_{5w}X_w . \end{aligned} \right\} \text{ (Model 2.1.1)}$$

The symbols are those denoting the variables appearing in Figure 2.1.1. The three variables with literal subscripts (u, v, and w) are the residuals for  $X_3$ ,  $X_4$ , and  $X_5$ , respectively, which must be included in the model to satisfy the condition of complete determination. In a recursive model of this type the usual assumption with respect to these residuals is that each is uncorrelated with the other variables directly influencing the dependent variable in question, and that they are uncorrelated with each other (Blalock, 1964). It is this set of assumptions

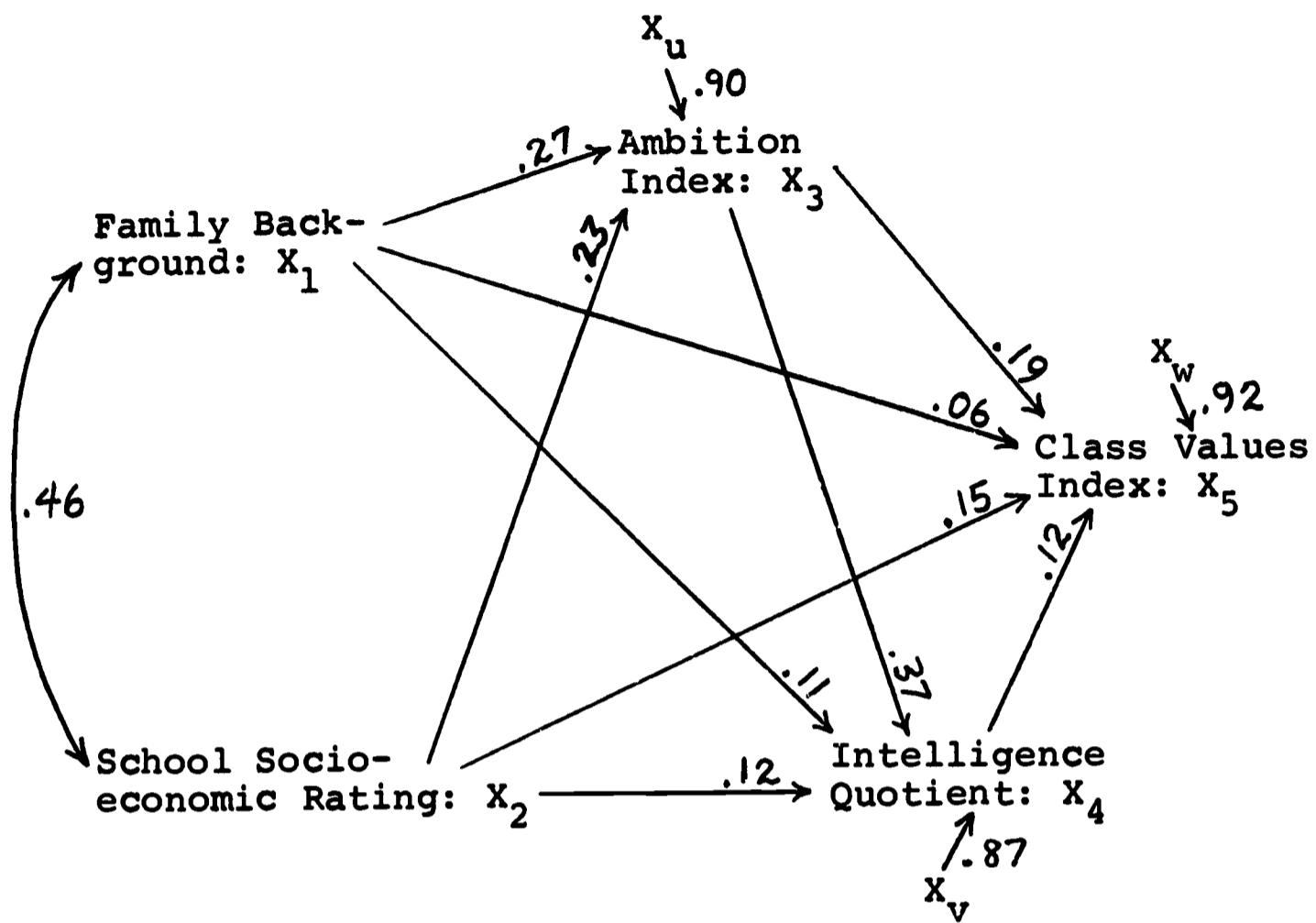

Figure 2.1.1.--Path Diagram Representing Causal Model Implicit in Turner's (1964) Study of the Determinants of Aspirations, with Path Coefficients Estimated from Correlations Reported by Him.

that provides the leverage needed to make numerical estimates from the empirical data. In the case at hand, therefore, the equations of the model are supplemented with the specification,  $r_{1u} = r_{2u} = r_{1v} = r_{2v} = r_{3v} = r_{1w} = r_{2w} = r_{3w} = r_{4w} = r_{uv} = r_{uw} = r_{vw} = 0$ . One further stipulation completes our statement of the assumptions underlying further algebraic and numerical work: all variables are taken to be in standard form; that is, each of the measured variables,  $X_1, \dots, X_5$  and each of the residuals  $X_u, X_v,$  and  $X_w$  has a mean of zero and a standard deviation of unity. All that is involved here is a simple transformation. If, for example, variable 3 as originally measured had a mean of  $\bar{V}_3$  and a standard deviation of  $\sigma_3$  in the sample under study, then we define  $X_3 = (V_3 - \bar{V}_3)/\sigma_3$  with similar definitions for the other variables.

On the understanding that the variables are in standard form, the coefficients (the  $p$ 's) in the equations are termed "path coefficients," and their interpretation goes as follows: In the first equation (for example), for a unit (standard deviation) change in  $X_2$  there is (on the average) a change of  $p_{32}$  in  $X_3$ , where  $p_{32}$  is the fraction of a standard deviation by which  $X_3$  changes, given unit change in  $X_2$ . (It need not be a proper fraction, inasmuch as path coefficients may have numerical values outside the range  $\pm 1.0$ .)

The reader is likely to have encountered path coefficients under the name of "beta-coefficients" or "beta-weights." The two concepts are interchangeable for a model like the one under examination; but path analysis also applies to cases in which the coefficients cannot be estimated by the straightforward procedure used in calculating beta's. One notational convention may be explained at this point. As is conventional for beta-coefficients and regression coefficients in raw-score form, the first subscript of the path coefficient denotes the dependent variable and the second subscript the causal or explanatory variable. Secondary subscripts, used with partial regression and beta-coefficients to identify the variables "held constant," as in  $\beta_{32.1}$ , are not employed in the notation for path coefficients, however. It will always be evident from the statement of the model, either in symbols or as a diagram, what other independent variables are involved. Note that while the order of the two subscripts must be carefully observed for the path coefficients, it is irrelevant for correlations, since  $r_{ij} = r_{ji}$ .

Although the distinction between path coefficients and conventional standardized regression coefficients may seem unnecessary at the moment, the reader may bear it in mind for future reference. For the present, the reader may wish to think of Model 2.1.1 as comprising a set of three regressions:  $X_3$  on  $X_2$  and  $X_1$ ;  $X_4$  on  $X_3, X_2,$  and  $X_1$ ; and  $X_5$  on  $X_4, X_3, X_2,$  and  $X_1$ . However, we shall later exhibit models in which conventional regression estimates are not applicable. Hence, it is advisable to state the general method by which estimates are secured, noting that it is equivalent to the calculation of a set of regressions under special circumstances, such as those applying in the present instance.

Let us suppose (as is in fact the case in this example) that we know all the correlations among the measured variables,  $X_1, \dots, X_5$ , in the sample of respondents for which the analysis is being made. Inasmuch as we are working with variables in standard form, the correlation coefficient takes on a very simple form: the correlation between any two of these variables, say  $X_i$  and  $X_j$ , is simply  $r_{ij} = \Sigma X_i X_j / N$ , where  $N$  is the number of cases in the sample. If  $i = j$ , we have

$$r_{ii} = \Sigma X_i X_i / N = \Sigma X_i^2 / N = 1.0$$

in view of the property that a variable in standard form has unit variance or that the correlation of a variable with itself is unity. It is now easy to show how any of the known correlations can be written in terms of an expression involving path coefficients and some other known correlations. Consider the first equation of Model 2.1.1.

$$X_3 = p_{32}X_2 + p_{31}X_1 + p_{3u}X_u .$$

Suppose we multiply both sides of the equation by  $X_2$  to obtain

$$X_2X_3 = p_{32}X_2^2 + p_{31}X_1X_2 + p_{3u}X_uX_2 .$$

Now, sum both sides of this equation over sample observations:

$$\Sigma X_2X_3 = p_{32}\Sigma X_2^2 + p_{31}\Sigma X_1X_2 + p_{3u}\Sigma X_uX_2 .$$

(The  $p$ 's may be written to the left of the summation signs because they are constants.) Finally, divide both sides by  $N$ :

$$\frac{\Sigma X_2X_3}{N} = p_{32}\frac{\Sigma X_2^2}{N} + p_{31}\frac{\Sigma X_1X_2}{N} + p_{3u}\frac{\Sigma X_uX_2}{N} .$$

But  $\Sigma X_2X_3/N = r_{23}$  and  $\Sigma X_2^2/N = 1.0$ , and so on, as we have just seen. Hence we may write:

$$r_{23} = p_{32} + p_{31}r_{12} + p_{3u}r_{2u} .$$

But  $r_{2u} = 0$  on the specification concerning correlations of residuals stated at the outset. Hence our final result is

$$r_{23} = p_{32} + p_{31}r_{12} .$$

To refer to the sequence of steps through which we have just gone, we may say that we "multiply the first equation through by  $X_2$  and simplify."

Let us now "multiply through" the first equation by  $X_1$ . We obtain in an exactly parallel fashion

$$r_{13} = p_{32}r_{12} + p_{31} .$$

Collecting our results thus far, we have

$$r_{23} = p_{32} + p_{31}r_{12} , \text{ and}$$

$$r_{13} = p_{32}r_{12} + p_{31} .$$

The three correlations appearing here are known, having been calculated from the data. The two path coefficients,  $p_{32}$  and  $p_{31}$ , are not known at the outset. But we now have two linear equations in two unknowns. Straightforward computational procedures for obtaining the solution for the two path coefficients are readily available.

Next, let us multiply through the second equation of the model by  $X_3$ ,  $X_2$ , and  $X_1$  in turn. The steps already described will lead us to a set of three equations in which appear three unknown path coefficients,  $p_{43}$ ,  $p_{42}$ , and  $p_{41}$ :

$$r_{43} = p_{43} + p_{42}r_{23} + p_{41}r_{13}$$

$$r_{42} = p_{43}r_{23} + p_{42} + p_{41}r_{12}$$

$$r_{41} = p_{43}r_{13} + p_{42}r_{12} + p_{41}$$

The same procedure applied to the third equation of the model, multiplying it through by  $X_4$ ,  $X_3$ ,  $X_2$ , and  $X_1$  in turn, yields four equations containing the four unknown path coefficients,  $p_{54}$ ,  $p_{53}$ ,  $p_{52}$ , and  $p_{51}$ :

$$r_{54} = p_{54} + p_{53}r_{34} + p_{52}r_{24} + p_{51}r_{14}$$

$$r_{53} = p_{54}r_{34} + p_{53} + p_{52}r_{23} + p_{51}r_{13}$$

$$r_{52} = p_{54}r_{24} + p_{53}r_{23} + p_{52} + p_{51}r_{12}$$

$$r_{51} = p_{54}r_{14} + p_{53}r_{13} + p_{52}r_{12} + p_{51}$$

We have, therefore, generated the "normal equations" from which we may solve for all the unknown path coefficients, except for the residual paths.

To find  $p_{3u}$  multiply the first equation through by  $X_3$  and simplify so as to obtain,

$$r_{33} = 1 = p_{32}r_{23} + p_{31}r_{13} + p_{3u}r_{3u}$$

The two path coefficients,  $p_{32}$  and  $p_{31}$ , have already been computed and may now be taken as known. But the foregoing equation appears to contain two unknowns,  $p_{3u}$  and  $r_{3u}$ . To resolve this difficulty, multiply through the first equation of the model by  $X_u$ , to obtain

$$r_{3u} = p_{32}r_{2u} + p_{31}r_{1u} + p_{3u}r_{uu} ;$$

whence  $r_{3u} = p_{3u}$  inasmuch as  $r_{2u} = r_{1u} = 0$  (by the specifications of the model) and  $r_{uu} = 1$ . Returning to the first equation in this paragraph, therefore, we have

$$p_{3u}^2 = 1 - p_{32}r_{23} - p_{31}r_{13} ,$$

which yields the solution for  $p_{3u}$ . The same type of formula is readily

derived for  $p_{4v}$  and  $p_{5w}$ . The calculation of these completes the set of numerical estimates for this model.

It will be noted that we gave an expression for each of the 10 correlations in Turner's data, except one,  $r_{12}$ . In this particular model, both  $X_1$  and  $X_2$  are "predetermined" variables. Correlations among predetermined variables are simply taken as given. On the path diagram, such ultimate or unanalyzed correlations are represented by a curved line linking the pair of variables, with arrowheads at both ends. Such a link does not represent any assumption or hypothesis as to causal relationship or dependence. Indeed, the model is entirely silent on the question of how correlation between predetermined variables may arise. In this case, someone might wish to argue that  $X_1$  causes  $X_2$ , that  $X_2$  causes  $X_1$ , that the two variables reciprocally influence each other, or that the two share some common cause which gives rise to the correlation between them. As long as we treat  $X_1$  and  $X_2$  as predetermined with respect to this model, it does not matter what the actual causal relationship between them is, for the only information we need is the degree of correlation between them.

## 2.2. Reduced Forms

As indicated by the introductory remarks in section 1.2, one of the attractive features of the type of model investigated here is that it makes explicit both the direct and the indirect effects of causal variables on dependent variables and allows for the possibility that one variable may be "dependent" with respect to its antecedents in a causal scheme but "causal" with respect to subsequent variables. All this is clearly suggested by the path diagram, but to see how these properties of the model work out quantitatively, we must carry out some more algebra.

Let us for the moment ignore the equation for  $X_5$  in model 2.1.1. Moreover, let us assume that Turner had proposed that IQ ( $X_4$ ) depends on family background ( $X_1$ ) and school rating ( $X_2$ ) without regard to ambition ( $X_3$ ). The diagram for this simple model is shown on the left in Figure 2.2.1. The model has only one equation,

$$X_4 = q_{42}X_2 + q_{41}X_1 + q_{4a}X_a \quad (\text{Eq. 2.2.1})$$

We use, temporarily, the symbol  $q$  for path coefficients, since the coefficients here are not the same as those in model 2.1.1. Again we specify that the residual is uncorrelated with the causal variables:

$$r_{2a} = r_{1a} = 0.$$

Now, if we substitute the first equation of model 2.1.1 into the second, we obtain

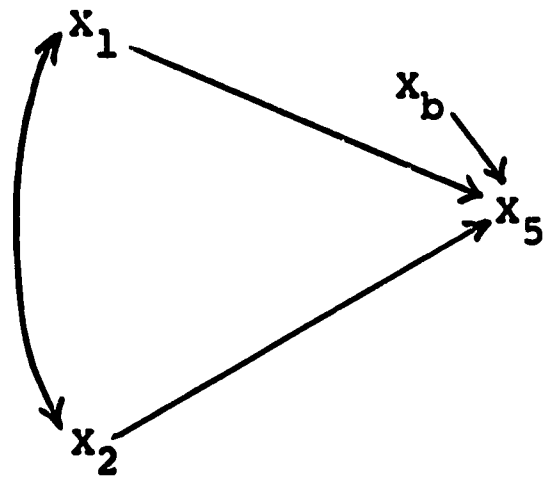
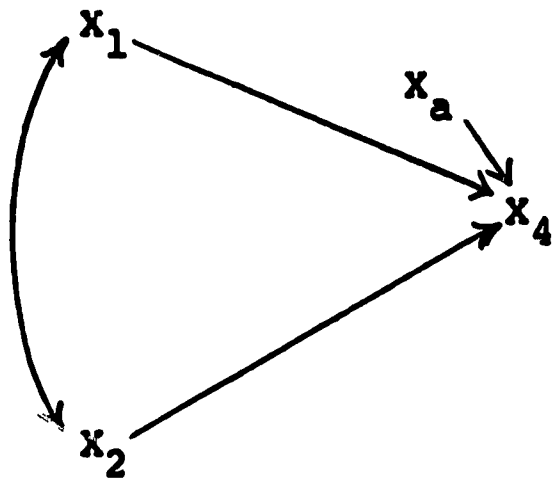

Figure 2.2.1.--Reduced Forms of Model 2.1.1 with  $x_4$  as the Dependent Variable and with  $x_5$  as the Dependent Variable.

$$X_4 = p_{43}(p_{32}X_2 + p_{31}X_1 + p_{3u}X_u) \\ + p_{42}X_2 + p_{41}X_1 + p_{4v}X_v$$

or, rearranging terms,

$$X_4 = (p_{42} + p_{43}p_{32})X_2 + (p_{41} + p_{43}p_{31})X_1 \\ + p_{4v}X_v + p_{43}p_{3u}X_u$$

This is seen to be of the same form as Eq. 2.2.1, upon making the following substitutions:

$$q_{42} = p_{42} + p_{43}p_{32} ;$$

$$q_{41} = p_{41} + p_{43}p_{31} ; \text{ and}$$

$$q_{4a} X_a = p_{4v} X_v + p_{43}p_{3u} X_u .$$

From the point of view of model 2.1.1,  $q_{41}$  is a composite path which sums up the direct effect of  $X_1$  on  $X_4$  as  $p_{41}$  and the indirect effect via  $X_3$  as  $p_{43}p_{31}$ . The relative magnitudes of the two quantities will frequently be of interest.

A more complicated composite path is disclosed when we work out the equation in the reduced form of model 2.1.1 in which  $X_5$  is the dependent variable. The same kind of algebra already illustrated permits the deductions:

$$q_{52} = p_{52} + p_{53}p_{32} + p_{54}(p_{42} + p_{43}p_{32})$$

$$q_{51} = p_{51} + p_{53}p_{31} + p_{54}(p_{41} + p_{43}p_{31})$$

Such expressions, in effect, exhibit the "mechanisms" by which the pre-determined variables bring about their effects on the dependent variables of a complex model.

One important comment follows from this demonstration of relationships between reduced form and extended form models. Almost any model, however complex, may be considered as a reduced form with respect to a model which gives a still more elaborate account of intervening variables. But the omission of such intervening variables from the reduced form does not mean that the latter is invalid. Thus, if model 2.1.1 is an acceptable representation of the process under study, then so are the reduced forms in Figure 2.2.1. If the investigator had begun with the three-variable equation depicted on the right side of Figure 2.2.1, the estimates of the paths  $q_{51}$  and  $q_{52}$  would have been correct, even though he could not, at that point, specify their composite nature. Two things are accomplished by the more elaborate model 2.1.1: (a) the "mechanisms" through which  $X_1$  and  $X_2$  influence  $X_5$  are made explicit and quantitative estimates of their relative importance are secured;



(b) variance in  $X_5$  due to intervening variables but independent of the predetermined variables is accounted for. Thus model 2.1.1 gives a more nearly complete explanation of  $X_5$  than does the reduced form, as well as a more explicit or detailed interpretation of the dependence of  $X_5$  on  $X_1$  and  $X_2$ .

To see how this comes about, let us recall that the residual,  $X_a$ , for the reduced form on the left side of Figure 2.2.1 was shown to be composed of two terms:

$$X_a = \frac{p_{4v}}{q_{4a}} X_v + \frac{p_{43}p_{3u}}{q_{4a}} X_u$$

Multiplying through this equation by  $X_u$ ,  $X_v$ , and  $X_a$  in turn (remembering the specification  $r_{uv} = 0$ ),

we find that  $r_{ua} = p_{43}p_{3u}/q_{4a}$ ,  $r_{va} = p_{4v}/q_{4a}$ ,

$$r_{aa} = 1 = (p_{43}^2 p_{3u}^2 + p_{4v}^2)/q_{4a}^2$$

and hence that  $q_{4a}^2 = p_{43}^2 p_{3u}^2 + p_{4v}^2$ .

This result may be rearranged as

$$1 - p_{4v}^2 = 1 - q_{4a}^2 + p_{43}^2 p_{3u}^2 ; \text{ or}$$

or  $R_{4(123)}^2 = R_{4(12)}^2 + p_{43}^2 p_{3u}^2$

where  $R_{4(123)}^2 = 1 - p_{4v}^2$  is the coefficient of multiple determination (squared multiple correlation) obtained when  $X_4$  is regressed on  $X_1$ ,  $X_2$ , and  $X_3$  and  $R_{4(12)}^2$  is the coefficient of determination for the regression of  $X_4$  on  $X_1$  and  $X_2$  only. The former exceeds the latter by the amount  $p_{43}^2 p_{3u}^2$ , which is easily computed given the estimates of path

coefficients for the extended form of the model. Hence, the introduction into the model of  $X_3$  as an intervening variable (between  $X_1$  and  $X_2$  on the one hand and  $X_4$  on the other) not only serves to elucidate the mechanisms by which the predetermined variables influence the dependent variable, but also to account for a greater part of the variation in the latter.

### 2.3. Partial, Partitions, and Paths

This section is something of a digression, but one that seems desirable in view of the confused interpretations of regression and correlation statistics so prevalent in sociology today. A number of problems studied by sociologists seem to hinge on the partitioning of

the "explained variance" in multiple regressions or on the calculation of a partial correlation. The word "seem" is used advisedly, for we shall argue that achieving an algebraically consistent partitioning or system of partialing is secondary in importance to setting up an appropriate representation (or "model") of the structure of the problem. Much confusion arises because of the protean character of regression and correlation statistics, which permits their algebraic manipulation into a large number of essentially equivalent but apparently distinct forms. Preoccupation with this algebra is not likely to generate anything new, for many capable statisticians have had a go at the subject during the twentieth century. Even worse, it is likely to distract one from the more urgent task of making sure that the regression setup itself is suited to the inferences and interpretations to be attempted.

The profusion of formulas notwithstanding, it appears that the essential principles in a partitioning of variance or in a calculation of partial coefficients for interpretive use can be reduced to those involved in the three alternatives that are obvious in the three-variable case. Suppose our three variables are  $X_3$ ,  $X_2$ , and  $X_1$ . Without loss of generality (since subscripts can be assigned arbitrarily), we may take it that a self-contained regression problem capable of being stated in terms of a recursive equation system (Blalock, 1964, pp. 54-57), thereby ruling out problems involving unmeasured variables or variables influencing each other reciprocally, will have one of the following three forms:

Case 1:  $X_3$  is prior to  $X_2$  and  $X_1$  but neither of the latter two is prior to the other. Stated otherwise,  $X_2$  and  $X_1$  depend on  $X_3$  but  $X_2$  does not depend on  $X_1$  nor does  $X_1$  depend on  $X_2$ .

Case 2:  $X_1$  depends on  $X_2$  and  $X_3$ , but neither of the latter depends on the other.

Case 3:  $X_1$  depends on  $X_2$  and  $X_3$ ; and  $X_2$  depends on  $X_3$ . This is the case of a causal chain. It should be noted that this model is not appropriate, for example, if there is reason to suspect that some fourth variable,  $X_4$ , is a common cause of  $X_3$  and  $X_2$ ; Case 2 represents the situation in which such a fourth variable is known or suspected to operate but has not yet been included in the model.

The three cases are diagrammed in Figure 2.3.1, following the conventions of path analysis.

Case 1 is the only one of the three cases in which the partial correlation as such provides a useful or immediately interpretable figure. It is easily shown for this case that

$$p_{23} = r_{23}, \quad p_{13} = r_{13}, \quad p_{2v} = (1 - r_{23}^2)^{1/2}, \quad \text{and} \quad p_{1u} = (1 - r_{13}^2)^{1/2}.$$

From this it follows at once that  $r_{12} = r_{13}r_{23} + p_{1u}p_{2v}r_{uv}$  and hence that  $r_{uv} = r_{12.3} = r_{21.3}$ . In this case,  $X_3$  is taken to be a "common

Case 1

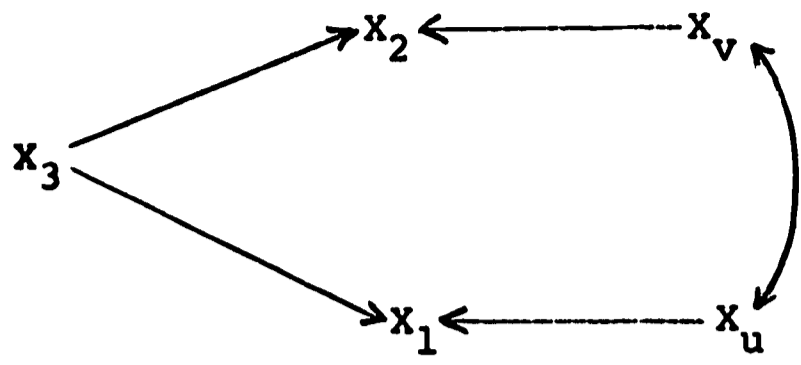

Case 2

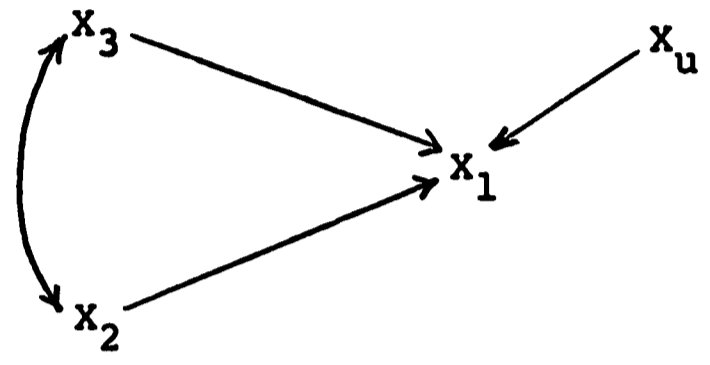

Case 3

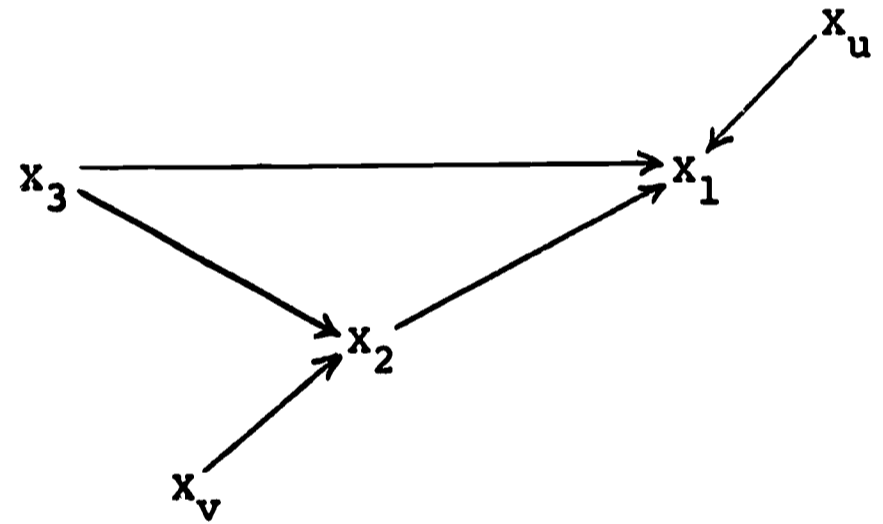

Case 3 (b)

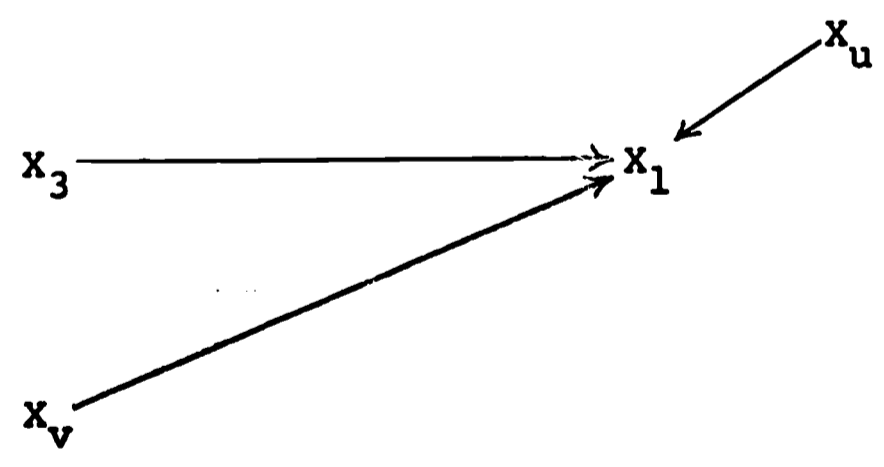

Figure 2.3.1.--Alternative Interpretations in the Three-Variable Problem.

cause" of  $X_2$  and  $X_1$ . The null hypothesis is that this common cause completely accounts for the correlation  $r_{12}$ . On this hypothesis,

$$r_{uv} = r_{12.3} = 0 \text{ and } r_{12} = p_{23}p_{13} = r_{23}r_{13}.$$

In the event that the null hypothesis is rejected, so that  $r_{uv} \neq 0$ , the interpretation is that some other common cause is operating in addition to  $X_3$ . On the model for Case 1, any such other cause(s) is taken to be uncorrelated with  $X_3$ . If this assumption is inappropriate, a more elaborate model is required, taking us beyond the three-variable problem. Case 1 does not involve the multiple correlation, or its square, the coefficient of determination.

In Case 2, straightforward multiple regression calculations provide estimates of the path coefficients, which are, in this simple kind of system, identical with "beta-weights" or partial regression coefficients in standard form. The problem--or better, the pseudo-problem--with this model is how to divide up the whole of the "explained variance" between the two explanatory variables. Each generation of novices repeats the mistake of computing (correctly)

$$R_{1(23)}^2 = p_{13}r_{13} + p_{12}r_{12}$$

and then interpreting (incorrectly) the two terms on the right as the unique contributions, respectively, of  $X_3$  and  $X_2$  to the explanation of the variance in  $X_1$ . This does not work, for the simple reason that the product, say,  $p_{13}r_{13}$  can be negative, and it makes no sense to attribute to one of the variables alone a negative component of an intrinsically positive quantity. Such a negative component can only arise from the joint action of two independent variables and must, therefore, be attributed to them jointly.

The natural partitioning for Case 2 is obtained from the following formula:

$$r_{11} = 1 \text{ (= total variance of } X_1) = p_{12}^2 + p_{13}^2 + 2p_{12}p_{13}r_{23} + p_{1u}^2$$

from which it follows that  $R_{1(23)}^2 = 1 - p_{1u}^2$ . We have, therefore, three

components of explained variance, one due to  $X_3$ , one due to  $X_2$ , and one due jointly to  $X_2$  and  $X_3$ . Nothing is gained by seeking an allocation of the joint term to one or the other of the two explanatory variables. If the rationale for doing so is examined closely, it will turn out that the analyst is either (a) using the model of Case 3 rather than Case 2, or (b) invoking assumptions about other variables not included in the system (in which case the situation is no longer that of a three-variable problem). If it seems unsatisfactory to recognize a (typically large) joint component, then the only recourse is, indeed, to enlarge the system, so as to include, for example, an explanation of the correlation  $r_{23}$ . This will require reference to other variables, measured or unmeasured, and a rejection or elaboration of the model for Case 2.

Case 3 is more interesting in that it presents a genuine dilemma. Since the model is that of a causal chain, we may be interested in looking at it in either of two ways: tracing back from the effect to the most immediate cause, and then further back to more remote causes; or following forward from the initial cause, looking at intervening causes along the way. In either event,  $p_{13}$  and  $p_{12}$  have the same values as in Case 2, while  $p_{23} = r_{23}$ . There is no difference between the two models in terms of the numerical coefficients to be entered on the path diagram. However, the assertion of priority of  $X_3$  with respect to  $X_2$  in this third case (along with the assumption that these two variables have no common causes inducing a "spurious" correlation between them) opens up the two alternatives just mentioned, neither of which makes sense in the context of Case 2.

Working backward from effect to cause, the appropriate partitioning of variance is

$$R_{1(23)}^2 = r_{12}^2 + p_{13}^2(1 - r_{23}^2).$$

The first term,  $r_{12}^2$ , represents the total effect of  $X_2$  including both its "unique" contribution to the variance of  $X_1$  and such contribution as it transmits from  $X_3$ . The second term,

$$p_{13}^2(1 - r_{23}^2),$$

represents the increment to explained variance secured by going back of the most immediate cause to include, in addition, a more remote one. To the extent that remote causes are shown to be significant in such a calculus, the analyst will conclude that the "history" of the system is relevant. In a simple causal chain (as in a simple Markov chain) such history is irrelevant, so that the second term is zero even though  $r_{13} \neq 0$ . Incidentally, for the case of the simple causal chain, Blalock (1964, pp. 85-87) has pointed out that the calculation of the partial correlation  $r_{12.3}$  is misleading. Indeed, here as in Case 2 there is really no role for partial correlations, even though they may be obtained (inconveniently) as an intermediate step in the calculation of the coefficient of determination. The circumstance that partial correlations may be involved in a computing routine does not compel the analyst to place a substantive interpretation on them.

The alternative interpretation of Case 3 involves going forward from the earliest cause to the effect. Thus the appropriate partitioning is

$$R_{1(23)}^2 = r_{13}^2 + p_{12}^2(1 - r_{23}^2).$$

The first term,  $r_{13}^2$ , represents the total effect of the most remote cause,  $X_3$ , on the dependent variable, while the second term,

$$p_{12}^2(1 - r_{23}^2),$$

is the increment to the explanation secured by including an intervening cause along with the initial one. This interpretation is clarified by noting that it is equivalent to

$$R_{1(23)}^2 = r_{13}^2 + r_{1v}^2, \text{ since } r_{1v} = p_{12}(1 - r_{23}^2)^{1/2}.$$

This partitioning, therefore, has the effect of replacing the intercorrelated independent (with respect to  $X_1$ ) variables  $X_3$  and  $X_2$  with two uncorrelated independent variables  $X_3$  and  $X_v$  whose contributions to explained variance are additive without remainder. Of course,  $X_v$  is not a directly measured variable but a construct, " $X_2$  freed of the influence of  $X_3$ ." This representation is shown in Figure 2.3.1 as Case 3(b).

While either of the two interpretations of Case 3 is consistent, legitimate, and informative, it makes no sense to attempt a calculation in which both interpretations are made simultaneously. The insoluble problem of achieving this (except in the limiting case of  $X_2$  and  $X_3$  being uncorrelated) is probably the one that so typically instigates the confusion in the minds of users of multiple regression.

The general lesson from the comparison of the three cases is that no interpretation whatever is possible, except on a definite assumption as to the anatomy of the system. While it is possible to make all the calculations reviewed, not to mention a number of others, from the same statistics, only a particular subset of such calculations (partitions or partials) will actually provide consistently interpretable results; and the choice among possible subsets will not be a free one, once a commitment as to the system's causal structure has been made. Like many another remark in the classic work on modern statistics, Fisher's statement (1946, p. 191) on partial correlation (quoted here with our interpolation indicating its equal application to multiple correlation) has too often been disregarded: "In no case . . . can we judge whether or not it is profitable to eliminate a certain variate unless we know, or are willing to assume, a qualitative scheme of causation. For the purely descriptive purpose of specifying a population in respect of a number of variates, either partial or total [or multiple] correlations are effective, and correlations of either type may be of interest." Further (Fisher, 1946, p. 190), "If . . . we choose a group of social phenomena with no antecedent knowledge of the causation or absence of causation among them, then the calculation of correlation coefficients, total or partial [or multiple], will not advance us a step towards evaluating the importance of the causes at work."

While the three-variable problem illustrates all the issues of principle, the application of the principles can involve some tedious algebra and can afford opportunities for confusion in more elaborate problems. In Figure 2.3.2 are sketched out some diagrams for the four-variable problem, but it does not seem worthwhile to write down all the formulas. If the analyst cannot teach himself to write them correctly, using the basic algebra of path analysis, it is unlikely that he is in a favorable position to apply them in vouchsafing an interpretation. A few remarks will suggest the complications that may arise.

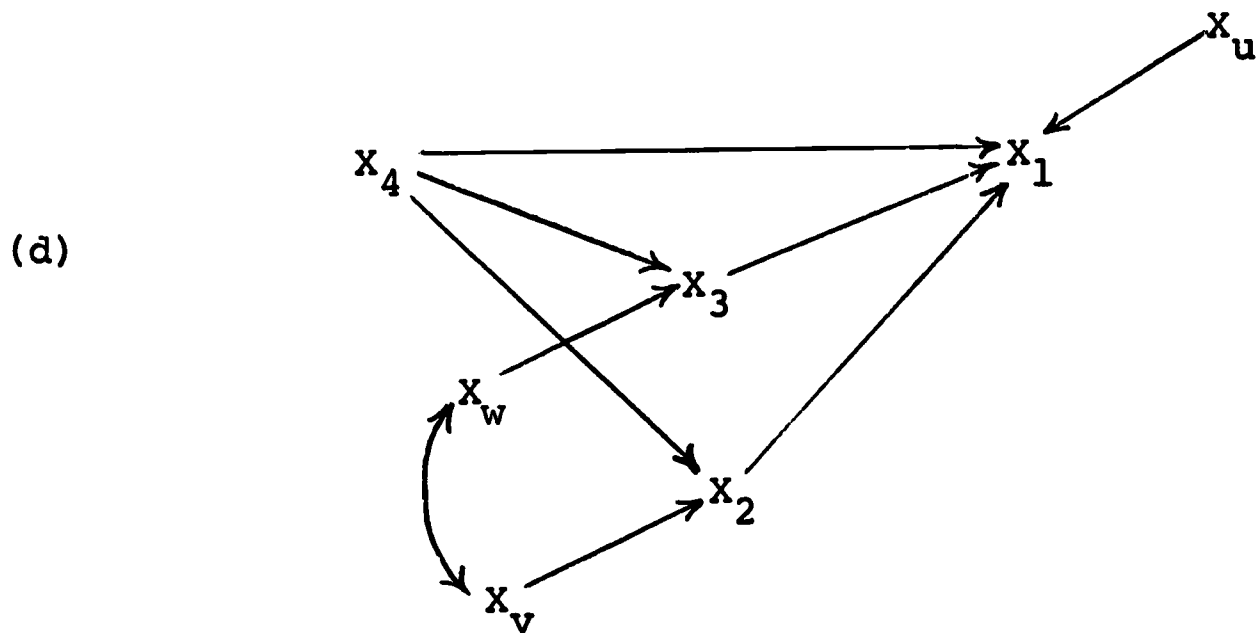
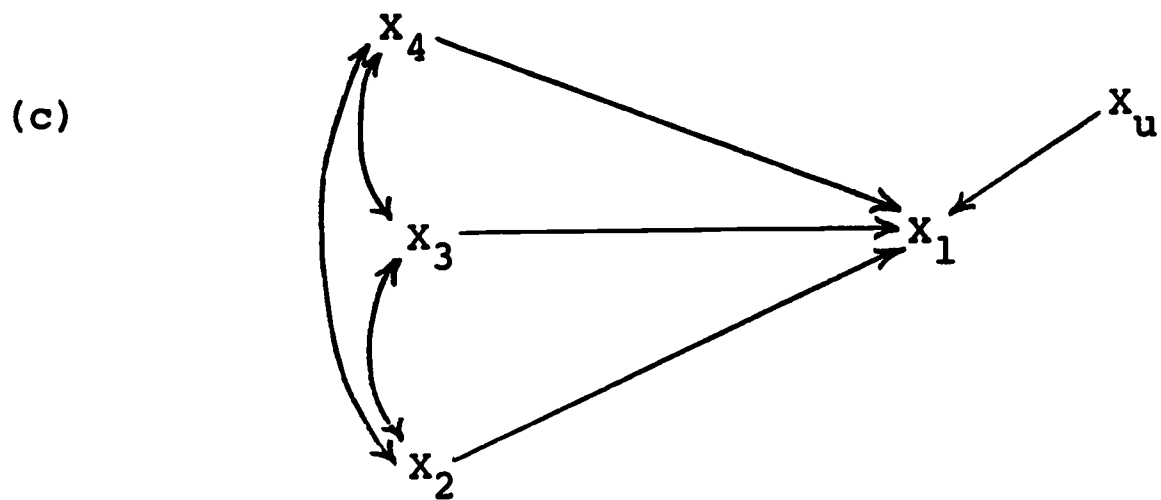
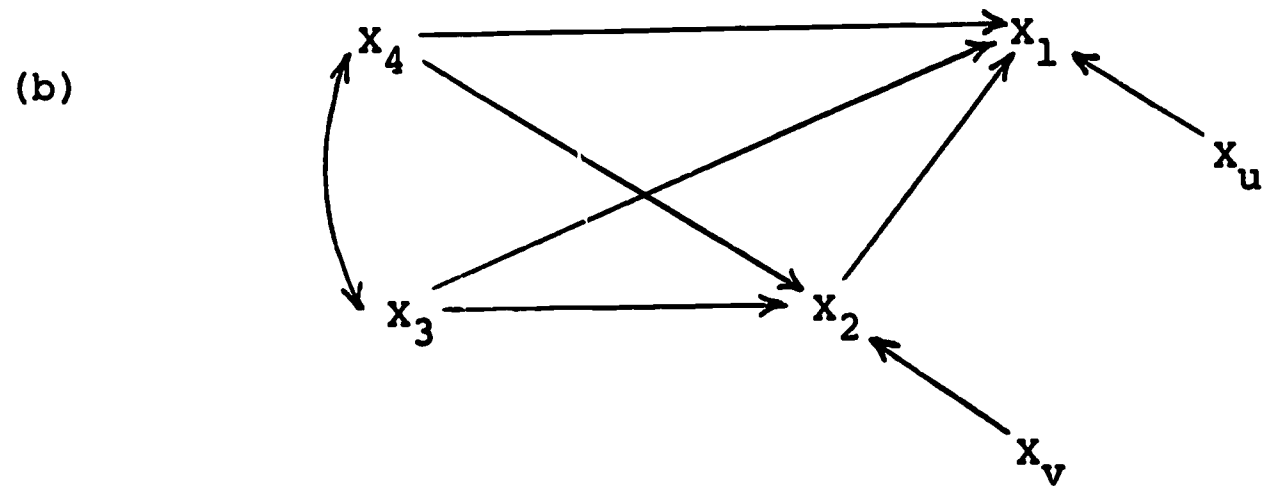
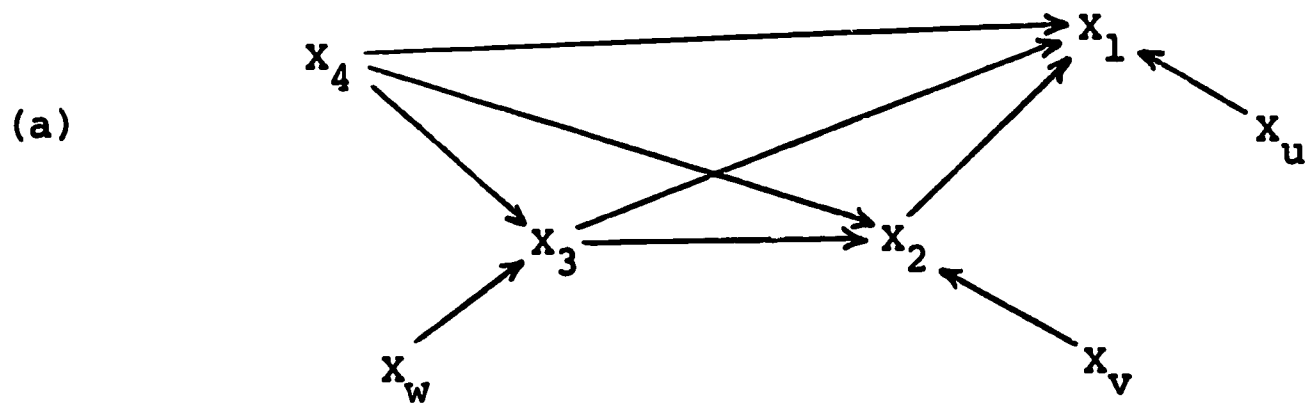
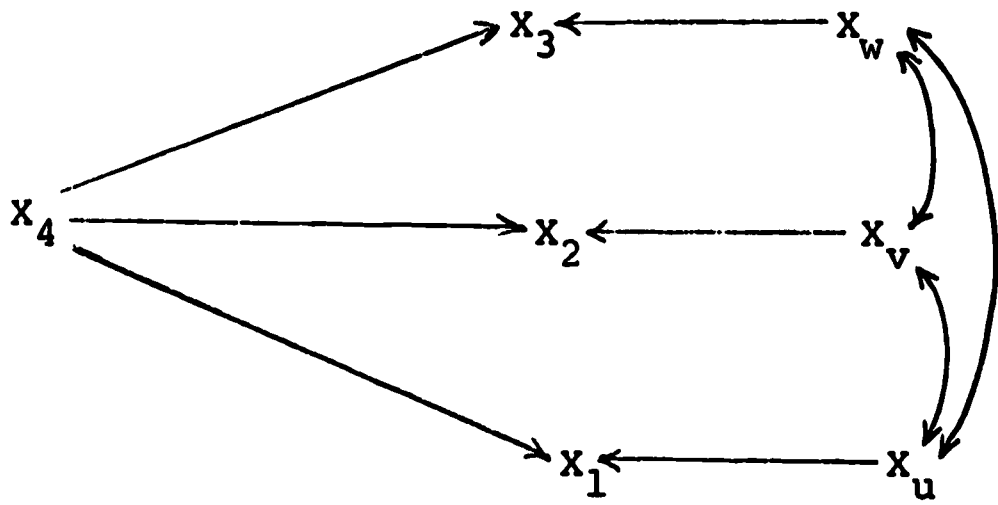
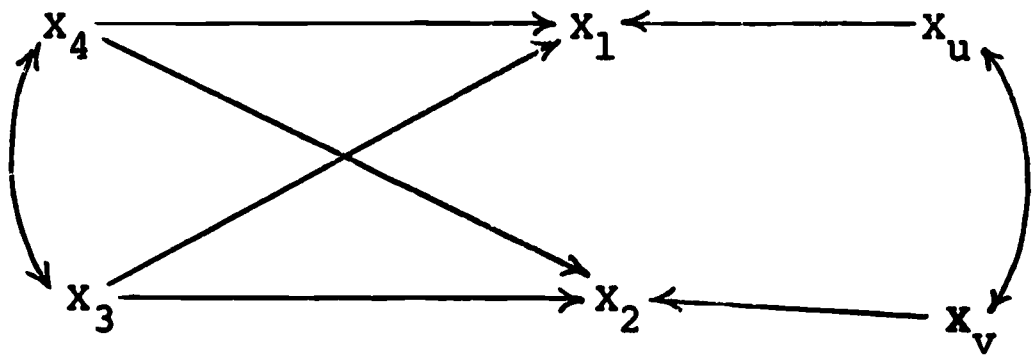

Figure 2.3.2.--Alternative Interpretations in the Four-Variable Problem. (continued on next page)

(e)



(f)



(g)

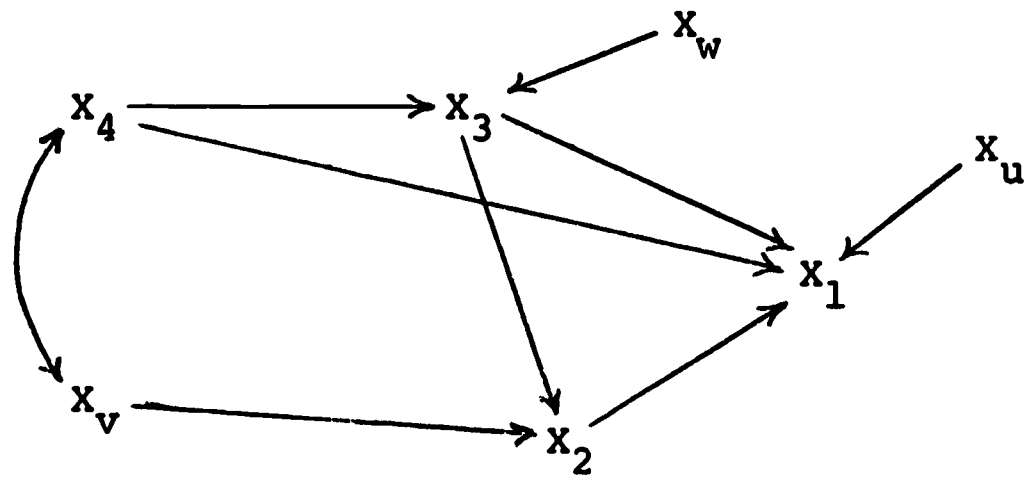

Figure 2.3.2.--Alternative Interpretations in the Four-Variable Problem (cont.).



Figure 2.3.2(a) shows the general case of the four-variable chain model discussed by Blalock (1962-63). His discussion is limited to a specification of necessary and sufficient conditions for one or more of the path coefficients to be zero. While he chooses to state these conditions in terms of partial correlations, such correlations have no useful role in interpreting numerical results obtained with this model. Much the more straightforward procedure, indeed, is to calculate the three regressions ( $X_3$  on  $X_4$ ;  $X_2$  on  $X_3$  and  $X_4$ ;  $X_1$  on  $X_2$ ,  $X_3$  and  $X_4$ ) involved in this model and to test the estimated regression (path) coefficients for significance. A partitioning of variance is obtained upon a straightforward extension of the approach already illustrated. Here, however, it may be easier to secure the desired partitioning making use of the definitions below:

Working backward, from effect to more and more remote causes,

$$\begin{array}{ll} \text{Total effect of } X_2: & r_{12}^2 \\ \text{Increment for } X_3: & R_{1(23)}^2 - r_{12}^2 \\ \text{Increment for } X_4: & R_{1(234)}^2 - R_{1(23)}^2 \\ \text{Sum, total variance explained:} & R_{1(234)}^2 \end{array}$$

Working forward,

$$\begin{array}{ll} \text{Total effect of } X_4: & r_{14}^2 \\ \text{Increment for } X_3: & R_{1(34)}^2 - r_{14}^2 \\ \text{Increment for } X_2: & R_{1(234)}^2 - R_{1(34)}^2 \\ \text{Sum, total variance explained} & R_{1(234)}^2 \end{array}$$

Various formulas involving manipulations of the differences listed above have sometimes been offered under the label "multiple-partial" correlation or "multiple-partial" coefficient of determination (Cowden, 1952). If one wants to express increments to explained variance on a relative rather than an absolute basis, such formulas are logical enough. They contribute nothing to the interpretation. As for statistical inference, the significance of the increments to explained variance can be assessed with the calculation of the appropriate F-ratios (Brownlee, 1960, p. 478), so that the "multiple-partial" approach contributes nothing to this problem either.

In Figure 2.3.2(b) the model is altered to the extent that no priority of  $X_3$  with respect to  $X_4$  or vice versa can be assumed. The foregoing partitioning can still be used, except that in working backward, the increments for  $X_3$  and  $X_4$  cannot be meaningfully separated, while in working forward the total effect of  $X_3$  and  $X_4$  jointly is taken as a single quantity,  $R_{1(34)}^2$ .

Figure 2.3.2(c) with no assumption as to ordering among the three variables taken to explain  $X_1$ , corresponds to a partitioning consisting of the sum of the three squared path coefficients and three joint terms. If, as is often true, the joint terms begin to assume a considerable size relative to the total variance explained, the analyst will do well to reconsider whether it really makes sense in his problem to try to separate the contributions of the three explanatory variables. (The "collinearity problem," adumbrated here, will receive further notice in later chapters.) Possibly all three independent variables may be better regarded as "indicators" of some more general characteristic, although to represent this (or other possible interpretations) requires further complication of the model and acceptance of additional assumptions.

Figure 2.3.2(d) invites a partitioning in which the contributions of  $X_3$  and  $X_2$  are combined. The numerical value of this component will depend on whether the contributions to explained variance are being cumulated forward from the most remote cause ( $X_4$ ) or back from the effect, assessing the two immediate causes first. Either point of view is legitimate and both are likely to be interesting. There is no possibility of a single set of numerical results that represents both simultaneously. It will be recognized that in Figure 2.3.2(d),  $r_{vw}$  is nothing other than the partial correlation  $r_{23.4}$ . Whether the analyst is satisfied with an interpretation that leaves unexplained a substantial value of this coefficient is a question that must be answered before letting the model stand as a final result.

Similarly, Figures 2.3.2(e) and 2.3.2(f) represent the other ways in which partial correlations naturally arise in the four-variable case. The former, 2.3.2(e), merely signifies the coexistence of three first-order partial correlations, each of which may be tested against the hypothesis that  $X_4$  is a common cause of the particular pair of dependent variables. If all three partials are essentially zero,  $X_4$  may be regarded as a common cause of all three dependent variables. The latter, 2.3.2(f), is, in effect, a definition of the second-order partial correlation,  $r_{12.34} = r_{uv}$ . Here the relevant hypothesis is that  $X_4$  and  $X_3$  jointly act as a common cause explaining the correlation  $r_{12}$ . There is no occasion for a partitioning of variance, nor is there in 2.3.2(e).

Finally, Figure 2.3.2(g) gives one example of what might be called a "pathological chain" model. The analyst is unwilling to assume that  $X_2$  depends directly on  $X_4$  yet the data do not permit him to accept the assumption of a simple causal chain,  $X_4 \rightarrow X_3 \rightarrow X_2$ , which implies that  $r_{24} = r_{23}r_{34}$ . This awkward state of affairs can be represented, formally, by a nonzero correlation  $r_{4v}$ . It is doubtful, however, that one would wish to leave the interpretation in this form if any plausible alternative were open. It merely stands for the conclusion that something has been omitted from the system that belongs there, such as a common cause of  $X_4$  and  $X_2$ . If this cause cannot be identified and measured at the moment, the diagram calls attention to the priority to be

given to its discovery. Under the circumstances, any partitioning of variance that yields an estimate of the gross influence of  $X_4$  on  $X_1$  can only be illustrative.

Little has been said in this presentation about the numerical values of the path coefficients in each of the diagrams. The calculations in each case are straightforward. In some cases, the analyst may be more interested in the values of these coefficients, which represent the relative weights of the variables in the system, rather than in a partitioning of variance, which produces estimates of their relative importance in an account of the sources of explained variance. The two viewpoints are virtually interchangeable in many cases, and one is usually involved, computationally, in reaching the other. The contribution of path analysis, however, lies not so much in rationalizing calculations of explained variance, but in making explicit the formulation of assumptions that must precede such a calculation, if it is to yield intelligible results. Moreover, the power of path analysis consists in the deductions it permits concerning systems more complicated than those of a straightforward recursive regression setup (Wright, 1931). In problems where systems of this kind afford an appropriate model, the calculation of explained variances is often an irrelevant or at best a secondary objective. Published examples of sociological research to substantiate this claim are not easy to cite, although work described later in this report seems to illustrate some of the more interesting possibilities.

## CHAPTER 3

### SOURCES OF DATA

The enumeration and description of the principal sources of data for this enterprise will be preceded by some general or philosophical remarks on the subject of data cumulation as a scientific strategy.

It is customary to complain that in sociology the results of discrete research projects are not additive in the sense that each new contribution builds on those preceding it while the accumulation of research results reveals a discernible pattern or structure. Sociology is, rather, a discipline of bits and pieces. If this judgment is just, it only raises the question of why it is so. Perhaps the usual answer is that discrete investigations do not share a common body of theory or conceptual framework. That answer is not accepted here. While there is merit in the major premise--that investigations manifest diversity in their theoretical orientations--the conclusion does not follow. The simple reason is that research operations--selection and measurement of variables, delimitation and sampling of populations, and so on--are seldom dictated by or even narrowly constrained by strictly theoretical considerations. They are more likely to be contrived by exercising a combination of emulation, expediency, and inspiration.

The more basic impediment to cumulative research is the simple lack of adequate attention to standardization and replication of research procedures. With sufficient attention to these matters and sufficient skill in execution, the results of research would begin to resemble the "interchangeable parts" that came to be used in machinery during the nineteenth century. That is, one investigator's findings could be juxtaposed with those of another working on the same topic and valid inferences could be drawn from the conjunction of the two, assuming the form of the inference could be justified in logic. This kind of juxtaposition is often attempted informally in the "commentary and discussion" section of research reports. But in this context, where the rules of scientific inference are relaxed in the hope of encouraging productive speculation, the quasi-inferences reached have only heuristic value. They do not represent an increment to firm knowledge (although, to be sure, they may stimulate some further effort to secure such an increment --but more likely some further "commentary and discussion" on a subsequent occasion).

These generalities preface a statement of the attitude taken toward data in this project. This attitude was rather eclectic, within a pair of constraints suggested by the initial formulation of the problem. The first constraint concerned the specification of the population to be studied. This population was defined as the adult male population of the contemporary United States in the central ages of working force participation. On occasion, well-defined subpopulations within this population are considered for separate study. It will be noted that the vagueness of the terms "contemporary" and "central ages" allows some considerable latitude in making specific decisions. Even more to the point, all sorts of approximations to the target population were accepted when there seemed to be reasonable grounds for doing so.

The second constraint related to the measurement of variables. The general classes of variables of interest to the project have been enumerated in section 1.3. A prospective data source was considered relevant to the project if it included measurements on some combination of variables in this enumeration.

With these constraints as guidelines, the project undertook a review of literature and a round of communication with investigators believed to be working on pertinent material. The first criterion for accepting a body of data was, of course, its availability, either in published reports or in unpublished files and computations. The second criterion, which served to put the above-mentioned constraints into effect, was that the data should be compatible with, or at least in some sense comparable to the OCG data sets that were available to the project as a legacy from previous projects or that were tabulated especially for this one. The abbreviation OCG stands for "Occupational Changes in a Generation," a survey that will be described below. Thus, if a prospective data set included some of the same variables as the OCG set and some additional variables of potential interest, and if the population covered was at least roughly (but presumably sufficiently) comparable to that covered in OCG (or some interesting subpopulation in the latter), it was considered as having a high potential utility to the project. As it turned out, the investigators' hopes for accumulating numerous data sets meeting the project specifications were somewhat too optimistic; yet a number of complete data sets and other fragments of information were uncovered whose availability had not been anticipated.

### 3.1. Description of Data Sets

(a) By far the most important data set, both in terms of logistics of data processing and analysis and in terms of contribution to the overall structure of the project was the OCG set. The existence of this body of information was due to a prior project with which the principal investigator was associated (Blau and Duncan, 1967). It had also served as a major resource in a related study (B. Duncan, 1965). The data were collected in conjunction with the March 1962 Current Population Survey (CPS) of the U.S. Bureau of the Census, via the regular CPS interview

and a supplementary questionnaire, "Occupational Changes in a Generation." In addition to the regular CPS items, including, among others, age, race, marital status, 1961 income, employment status, occupation, industry, and educational attainment, the supplement provided such items as ethnic background, educational attainment and occupation of the head of the respondent's family of orientation, his number of siblings, educational attainment of his oldest brother, occupation and industry of first job, and age upon entering the first job. Some 20,700 respondents in this survey represented the approximately 45 million men in the U.S. civilian non-institutional population between the ages of 20 and 64 in March of 1962. All reports on occupation (that of the head of the respondent's family, that of his own first job, and his current or most recent occupation as of March 1962) were coded to the census detailed classification and subsequently recoded to scores on the scale of occupational socioeconomic status devised by Duncan (1961a).

Although the previously mentioned projects using these data had acquired rather voluminous tabulations, which were available to the present project, there remained for further analysis a number of interesting relationships not hitherto adequately studied. Hence, the present project secured from the Bureau of the Census additional extensive tabulations differing in form rather substantially from any that were already available. These permitted somewhat closer specifications of the several subpopulations to be studied and facilitated computations of the kind required by the particular type of model used in the project.

(b) The only other major set of nationally representative data was another CPS supplement, conducted as an adjunct to the October 1964 survey. The data were collected by the Bureau of the Census for use in a study of military manpower carried out at the National Opinion Research Center (NORC) on behalf of the Department of Defense (Klassen, 1966). Although this CPS supplement covered all civilian noninstitutional men 16 to 34 years old, this project made use of just the subset of data for white men 25 to 34 years old. Several variables in the CPS-NORC set were designed to be closely comparable with OCG items. One major use of the former, therefore, was to secure a replication of OCG results. The outcome of this replication was highly satisfactory. The second major use of the CPS-NORC data was in constructing models involving mental ability (Report #3). The respondents in the 1964 supplement who were veterans of military service were matched to their service records, from which there were extracted the scores on the Armed Forces Qualification Test. In addition to mental ability scores (for veterans only) the CPS-NORC set includes such variables of interest to this project as educational attainment, current occupation, total earnings in 1964, occupation and earnings of first job, and father's occupation and education.

(c) Although no original data were collected expressly for this project, the project did take advantage of the opportunity to cooperate with a survey that began at about the same time. This was the 1966 Detroit Area Study (DAS), an annual study conducted at The University of Michigan. The directors of the 1966 DAS, Professors Howard Schuman and

Edward O. Laumann, kindly incorporated into their survey instrument a number of questions of interest to this project, so that many of the OCG items are fairly closely replicated in the DAS set. In addition, the latter includes a measure of mental ability, the "Similarities" subtest of the Wechsler test of adult mental ability. Also of interest to this project were two efforts made in the DAS to secure indicators of strength of achievement motivation; these efforts were not wholly successful, however. The target population for the 1966 DAS comprised native white men 21 to 64 years of age residing in the Detroit metropolitan area. Thus, these data permit a replication in a local setting of the national results secured from the OCG and CPS-NORC sets. In addition to the interest in this replication, the DAS set permitted study of a particular measurement problem: the effect of using alternative measures of occupational status. All the occupation entries on the DAS schedule were coded by the staff of this project, adhering closely to the census detailed occupation code and associated procedures. It was then possible to recode occupations in any fashion desired. Of particular interest was the comparison between scores on Duncan's (1961a) socioeconomic index of occupational status and scores on the occupational prestige scale (thus far unpublished) resulting from the work of Robert W. Hodge, Paul M. Siegel, and Peter H. Rossi at the National Opinion Research Center, 1964-67.

(d) The FGMA data set afforded material for one of the most intensive analyses of the project (see Report #5). The identification FGMA stands for Family Growth in Metropolitan America, the title of the monograph by Westoff and associates (1961) for which these data were originally collected. These data were of strategic importance, not because of the population covered--it was a rather curiously defined one--but because of the considerable effort that had gone into the attempt to measure motivational variables. The FGMA population consisted of couples who at the time of the survey, in 1957, had recently had a second child. The sample was drawn from birth records of several major metropolitan areas. Psychological measures were available for 941 husbands. Collateral information on these men included several items closely similar to OCG variables: father's occupation, number of siblings, educational attainment, occupation and income at marriage, and current occupation and income. The occupation items in FGMA were coded to the North-Hatt prestige scale (Reiss and others, 1961). This precludes a strict replication of OCG results, but provides data roughly comparable to the DAS set, making use of the occupational prestige recodes included in the latter.

(e) All of the data sets thus far described, like the bulk of the data available to this project, derive from cross-sectional studies. The time dimension enters in via retrospective questions used to ascertain such information as father's occupation or respondent's first job. In contrast with this type of study, a major research effort under the direction of William H. Sewell at the University of Wisconsin involves a longitudinal design. The baseline measurement derives from a questionnaire survey of all Wisconsin high school seniors in 1957. A probability

sample comprising approximately one-third of the initial respondents was followed up in 1964-65, and a response rate of 87 per cent was obtained. Among the more important variables measured in 1957 are intelligence, high school grades, occupational aspirations, educational plans, and parental socioeconomic status. The follow-up survey provided data on educational attainment, as of the seventh year beyond high school, and occupational status at that time. One other special feature of the WISC data set is that aggregate measures on the high schools attended by the respondents are available, making possible analyses designed to test for hypothesized "school effects."

The present project has not attempted a comprehensive analysis of the WISC data. That task is in progress at the University of Wisconsin and there is no need for duplication of effort. Instead, we have used the WISC data for certain special purposes at particular points in the course of the project as well as a particularly significant replication, given the longitudinal design of the WISC study, as contrasted to the cross-sectional design of the other data sets.

(f) All of the data sets described thus far were used, in one way or another, to make possible substantive analyses not contemplated by the original investigators. In contrast, sets described in paragraphs (f) and (g) were exploited for more strictly methodological purposes. That is, the problem as formulated by the original investigator was much the same as the one defined for this project; but in the latter case there was a commitment to a particular type of model, differing considerably from the analysis format of the original study.

One of these "secondary analyses" was done on data originally collected by Survey Research Center in 1957 for a national study of mental health. A subsample of respondents, including 715 men, were administered TAT tests for the purpose of indexing strength of achievement, affiliation, and power motives. These data were used by Crockett (1962) in an investigation of the role of achievement motivation in intergenerational occupational mobility. Additional specifications on the population to be covered as well as deletions dictated by missing information reduced Crockett's sample to 368 cases. Further losses were sustained in our re-analysis, since not quite all the original schedules could be located in SRC files. In any event, the small size of the available sample means that this material is not well suited to the estimation of parameters. Our interest in the SRC data set was primarily in ascertaining whether Crockett's conclusions on the role of achievement motivation would be sustained in the framework of the kind of model used in this study.

(g) Similarly, in working with data provided by Professor Archibald O. Haller of the University of Wisconsin, we were particularly interested in re-examining (see Report #7) a relationship detected in his previous work (Haller and Butterworth, 1960) using methods rather different from those suggested by the basic model employed in this project. These data were generated in a survey of all 17-year old boys



in school in Lenawee County, Michigan, during the spring of 1957. Interviews and test data were secured for 442 persons, but for the analyses of interest here, the sample was restricted to the 329 boys for whom information was available on their best friends. Clearly, this sample does not afford a secure basis for estimates of parameters for the whole U.S. population. The MICH data set does, however, provide unique or virtually unique information on an interesting set of variables: levels of educational and occupational aspiration of the boys, the socioeconomic status of their parents, the measured intelligence scores of the boys, and their estimate of their parents' encouragement of high achievement levels. The same data are available for the "best friends" of the boys.

(h) In addition to the seven major sources of data that have been described, a number of other items of information were reviewed and sometimes incorporated into analyses. These are bits of data of a somewhat more fragmentary nature rather than the somewhat substantial data matrices afforded by sources (a) through (g). It should be noted, moreover, that in regard to the latter it was not the intention of the project to perform exhaustive analyses or data summaries. Instead, each data source, whether it was rather compendious or comparatively restricted in the amount of information it provided, was examined selectively in the light of the specific objectives of the project, as outlined in Chapter 1. Given the somewhat unusual character of these objectives, the use of source materials involved the project in rather little duplication of the work of original investigators.

## CHAPTER 4

### THE BASIC MODEL

The main outlines of the process of occupational achievement, as it is observed to operate in the male population of the contemporary United States, have been established by previous research (Blau and Duncan, 1967). That is, we now have firmly based estimates of the degree to which achieved occupational status depends on the socioeconomic level of the family of orientation, the extent to which education serves as an intervening variable in the transmission of status, the extent to which it introduces variability into occupational achievement that is independent of origins, and the contributions of certain other background factors to level of status attained in adulthood. This chapter will recapitulate some of the results of this prior research, but cast them into a somewhat different form for purposes of better comparison with the results of the present project. It will also summarize a replication of the earlier results and consider a salient methodological problem--that of the variation in findings due to variation in the technique of measuring occupational status. All the data in this chapter pertain to the subpopulation of adult white men. Explicit comparisons between white and Negro men appear in the next chapter.

#### 4.1. Occupational Achievement in Four Cohorts

The OCG data were retabulated for this project so as to secure correlations among the major variables for native non-Negro men in four age groups, as of March 1962: 25-34, 35-44, 45-54, and 55-64 years of age. Table 4.1.1 presents the correlations needed for calculations on the version of the basic model to be presented here. These correlations are for men with nonfarm origins; that is, the head of the family in which the respondent grew up was not pursuing the occupations farmer, farm laborer, and the like as of the respondent's age 16. Although most results differ fairly little when farmers' sons are included, it seems conceptually simpler to deal with the nonfarm sector separately, since the perplexing question of status comparisons between farm and nonfarm jobs can be avoided. (There is so little movement from nonfarm origins to farm occupations that it is not necessary to remove such cases from the data.)

Table 4.1.1.--Simple Correlations between Variables Entering Into the Basic Model, for Non-Negro Men with Nonfarm Background, in Experienced Civilian Labor Force, by Age: March 1962

Age Group and Variable	Correlation with:					Mean	Standard Deviation
	X	T	U	Y	H		
<u>25-34</u>							
V Father's education	.4885	-.2691	.4017	.3420	.1534	9.17	3.53
X Father's occupation	...	-.2290	.4133	.3534	.2019	34.59	22.35
T Number of siblings	...	...	-.3262	-.2475	-.1523	3.49	2.86
U Education	...	...	...	.6510	.2726	12.38	3.04
Y Occupation, 1962	...	...	...	...	.3369	43.34	25.01
H Income, 1961 (\$1,000)	...	...	...	...	...	6.14	4.29
<u>35-44</u>							
V	.5300	-.2871	.4048	.3194	.2332	8.55	3.72
X	...	-.2476	.4341	.3899	.2587	34.41	23.14
T	...	...	-.3311	-.2751	-.1752	3.77	2.88
U	...	...	...	.6426	.3759	11.95	3.20
Y	...	...	...	...	.4418	44.78	24.71
H	...	...	...	...	...	7.50	5.36
<u>45-54</u>							
V	.4863	-.2395	.3685	.2517	.1902	8.15	3.69
X	...	-.2301	.4454	.3777	.3032	32.99	22.35
T	...	...	-.2997	-.2341	-.1329	4.09	2.96
U	...	...	...	.5949	.3635	11.25	3.28
Y	...	...	...	...	.4376	42.41	23.76
H	...	...	...	...	...	7.74	6.81
<u>55-64</u>							
V	.5313	-.2749	.3534	.3022	.1595	8.38	3.66
X	...	-.2398	.3879	.3543	.1871	34.06	23.16
T	...	...	-.2817	-.2565	-.1122	4.46	3.09
U	...	...	...	.5576	.3071	10.47	3.61
Y	...	...	...	...	.3799	42.73	24.62
H	...	...	...	...	...	6.99	6.37

Source: OCG data set.

There is no immediate need to comment on particular correlations in Table 4.1.1. They are, in effect, the raw material for the calculations next to be reported. These calculations take the form of three regressions in a recursive set, which are suggested by a causal argument advancing the following propositions: (1) Educational attainment depends on three characteristics of the family of orientation, the respondent's number of siblings and the occupational level and educational attainment of his father (actually, the head of the family, in the event of the father's absence). (2) Occupational status in 1962 depends on educational attainment and the foregoing three family background items. (3) Income depends on occupational status, educational attainment, and the three characteristics of the family of orientation.

Inasmuch as achieved occupational status was ascertained as of March 1962 while income was measured for the year 1961, there is an apparent inversion of the temporal order of the variables relative to the foregoing assumptions about causal order. In view of the compelling considerations that lead one to think of income as depending on occupation, rather than vice versa, we shall have to regard 1961 income as a proxy for 1962 income, i.e., as a somewhat fallible measure thereof. This is a customary procedure in analyzing data on income collected by the Bureau of the Census, but little evidence exists on the seriousness of the error it incurs.

Our procedure then, is to regress U on T, X, and V; then Y on U, T, X, and V; and finally, H on Y, U, T, X, and V. (See Table 4.1.2 or Figure 4.1.1 for identification of these letter symbols.) The regressions were computed within each cohort, and the results are displayed in Table 4.1.2. In Figure 4.1.1 the regression coefficients have been taken as estimates of the path coefficients of the causal diagram. Just as a way of simplifying the diagram so that the main results are clearer, coefficients less than .05 in absolute magnitude are not shown and the corresponding paths are deleted (even though some of these small coefficients might be statistically significant on a conventional test). For illustration, the results are displayed in the graphic form for only one cohort, men 35 to 44 years old in 1962. Most of the important features of the results are, however, shared by all the cohorts.

Each of the three family background factors directly influences education in an appreciable degree. Results for all four cohorts suggest that father's occupation is a slightly more weighty factor in educational attainment than either father's education or number of siblings, when all three variables are considered simultaneously. The effect of number of siblings is negative, implying that an increase in family size lowers the number of grades of school completed. For greater detail on this portion of the model, see B. Duncan (1967).

In the regression of occupation on education and the three family factors, the former emerges as by far the most important direct influence. There is an interesting age gradient in the magnitude of the coefficient for education, which runs from .47 for the oldest cohort to

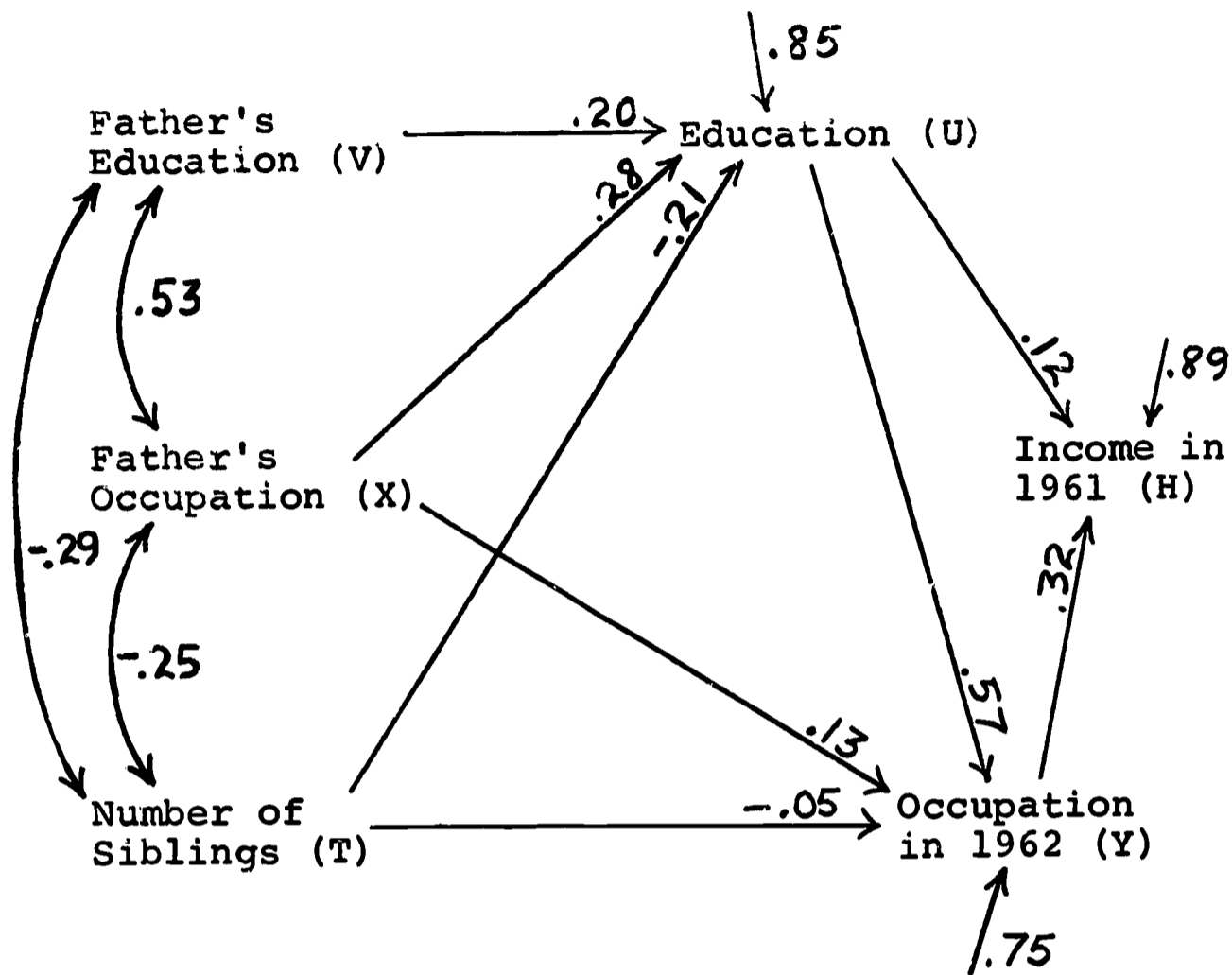

Figure 4.1.1.--Basic Model of the Process of Achievement, with Path Coefficients Estimated for non-Negro Men with Nonfarm Background, 35-44 Years Old, in Experienced Civilian Labor Force, March 1962. (Source: OCG data set. Path not shown where coefficient is less than .05 in absolute value.)

Table 4.1.2.--Partial Regression Coefficients in Standard Form for Recursive Model Relating Achieved Statuses to Family Background Factors, by Age, for Non-Negro Men with Nonfarm Background, in Experienced Civilian Labor Force: March 1962  
(Parentheses enclose each coefficient less than its standard error in absolute value)

Age and Dependent Variable*	Independent Variables*					Coefficient of Determination
	Y	U	T	X	V	
<u>25-34</u>						
U (Education)	...	...	-.2080	.2585	.2194	.263
Y (Occupation)	...	.5875	-.0216	.0744	.0638	.436
H (Income)	.2635	.0556	-.0542	.0794	(-.0124)	.126
<u>35-44</u>						
U	...	...	-.2053	.2780	.1985	.269
Y	...	.5668	-.0540	.1266	(.0073)	.431
H	.3247	.1193	-.0201	.0492	.0494	.216
<u>45-54</u>						
U	...	...	-.1856	.3210	.1680	.260
Y	...	.5245	-.0494	.1442	-.0235	.372
H	.3204	.1153	(.0079)	.1298	(.0059)	.222
<u>55-64</u>						
U	...	...	-.1736	.2562	.1695	.208
Y	...	.4687	-.0810	.1285	.0460	.342
H	.2970	.1293	(.0104)	(.0277)	(.0122)	.159

\*V: Father's (or family head's) educational attainment  
X: Father's (or family head's) occupational status  
T: Respondent's number of siblings  
U: Respondent's educational attainment  
Y: Respondent's occupational status, March 1962  
H: Respondent's income in 1961

Source: Table 4.1.1.

.59 for the youngest. These data alone do not, however, permit an inference as to time trend in the closeness of association between educational level and occupational achievement, since the cohorts differ in duration of experience in the labor force.

A consistent finding over cohorts is that number of siblings has a negative influence on occupational achievement. The path coefficient  $p_{YU}$  measures the direct influence; in addition, number of siblings operates negatively on occupational achievement by way of education, as may be seen in multiplying the paths  $p_{YU}p_{UT}$ . In the oldest cohort the direct and indirect influences are about equal in size; in the younger cohorts the indirect influence assumes a greater relative importance.

Comparing the coefficients measuring the direct dependence of occupation on father's occupation and education respectively points up a prevalent kind of ambiguity encountered in regression models. These two variables are intercorrelated to the extent of about .5 in each cohort. With this much collinearity between independent variables it becomes very difficult to estimate the separate effects of each. Thus, we notice considerable instability in the relative magnitudes of the coefficients over the four cohorts. In all cases, father's occupation does have the higher coefficient, as one would expect a priori. In one cohort, however, the two are about equal, while in the immediately older cohort father's education has a coefficient of essentially zero. In another cohort, the estimate of the coefficient for father's education comes out slightly negative, a result which would be difficult to interpret substantively. It appears, therefore, that slight fluctuations in the zero-order correlations of these variables with the dependent variable, given the intercorrelation of the former, suffice to alter considerably the estimate of the nature of their respective direct influences. In this situation, many investigators consider that the attempt to separate the influences of the two variables is hopeless, and they resort to some such procedure as combining scores on the two variables into one composite score with more or less arbitrary weights. In several of the data sets used in this project, such a procedure had been followed; so that in future chapters we shall often encounter measures of so-called family socioeconomic status, rather than specific variables like father's occupation or education.

It may be seen that the problem alluded to here appears also in regard to income as the dependent variable. In both cases, we feel that a prima facie case for father's occupation as the more central influence can be made; and such a case is not wholly inconsistent with the results. Hence, if it were necessary to present a single estimate of the effects of family socioeconomic level, we should be tempted to repeat the regression calculations simply omitting father's education as an independent variable for respondent's occupation and income. Father's occupation would then be in some measure a proxy for the various measures on family socioeconomic status that could be suggested as well as a "cause" in its own right. It appears that the attempt to distinguish between these two roles would founder on the obstacle presented by high collinearity.

To summarize the interpretive conclusion on the point at issue, Figure 4.1.1 shows father's occupation as a direct influence on respondent's occupation, but father's education as only an indirect influence. As measured by  $p_{YU}p_{UV} = .11$  this indirect influence is not negligible.

We turn, finally, to the portion of the model which regards income as the dependent variable with all the five prior variables considered as possible direct influences on it. Reviewing the results for all four cohorts, the main common pattern is that the coefficient for occupation is substantial while that for the direct influence of education is appreciable. In all four cohorts, the indirect influence of education via occupation is greater than the direct influence, i.e.,  $p_{HY}p_{YU} > p_{HU}$ . This supports the conclusion reached by less precise methods that "an educational advantage is translated into an income advantage primarily, though not exclusively, by pursuing an occupation in which the prevailing income level is comparatively high" (Duncan, 1961b, p. 788).

The results are less consistent for the three family background factors. In any case, their direct impact on income seems to be slight. We must bear in mind, of course, that two very important intervening variables are included in the model, so that it would, in fact, be rather anomalous if family background appeared to have a substantial direct influence on income. To report that such a direct influence is slight is not to say that the background factors are unimportant, merely that their influence is largely indirect. To clarify the point, Table 4.1.3 presents regression coefficients for the three reduced form equations of the model, wherein each of the dependent variables is regressed on only the three family background factors. In this pattern of analysis, intervening variables are not explicitly recognized, so that one may compare directly the three dependent variables with respect to the magnitude of total impact of background variables on them.

The outcome of this analysis is quite clear: each of the background variables as well as the combination of all three has its greatest impact on education and its least on income, with the impact on occupational status being intermediate. With one minor inversion ( $p_{UX}$  for age group 35-44) this ordering is recapitulated in each of the four cohorts. Substantively, we are led to the conclusion that family background matters most for attainments that are close in time to the period of residence in the family of orientation and has a progressively attenuated influence on achievements coming later and later in the life cycle.

This conclusion must, of course, remain tentative. It is vulnerable to the possibility that we have failed to measure some factor or factors in family background that have a different pattern of impact on achievement. In particular, it will not have escaped the reader that we have no measure of the income or wealth of the family of orientation, although father's education and occupation are in a moderate degree presumably correlated therewith.



Table 4.1.3.--Partial Regression Coefficients in Standard Form for Reduced Form of Recursive Model Relating Achieved Statuses to Family Background Factors, by Age, for Non-Negro Men with Nonfarm Background, in Experienced Civilian Labor Force: March 1962

Age and Dependent Variable*	Independent Variables*			Coefficient of Determination
	T	X	V	
<u>25-34</u>				
U (Education)	-.2080	.2585	.2194	.263
Y (Occupation)	-.1438	.2263	.1928	.181
H (Income)	-.1036	.1534	.0506	.055
<u>35-44</u>				
U	-.2053	.2780	.1985	.269
Y	-.1703	.2842	.1198	.196
H	-.0998	.1746	.1120	.089
<u>45-54</u>				
U	-.1856	.3210	.1680	.260
Y	-.1467	.3126	.0646	.169
H	-.0605	.2669	.0459	.098
<u>55-64</u>				
U	-.1736	.2562	.1695	.208
Y	-.1624	.2486	.1255	.168
H	-.0603	.1347	.0714	.043

\*V: Father's (or family head's) educational attainment

X: Father's (or family head's) occupational status

T: Respondent's number of siblings

U: Respondent's educational attainment

Y: Respondent's occupational status, March 1962

H: Respondent's income in 1961

Source: Table 4.1.1.

Speculation on this matter may be aided by a hypothetical calculation. Let us imagine a hypothetical variable, "Z," which may stand for "father's wealth" or "father's income." Let us say that for respondents in the 35-44 year-old age group the correlations of the background variables with "Z" are as follows:  $r_{XZ} = .44$ ,  $r_{YZ} = .38$ , and  $r_{TZ} = -.14$ . Let us take as a further hypothesis that the combination of "Z" and the other three background variables yields a coefficient of determination,

$$R_{H(ZTXV)}^2 = .269;$$

this has been chosen for illustration to be the same as

$$R_{U(TXV)}^2 = .269$$

since we want to consider the possibility that income in the hypothetical case is as closely dependent on family background as is education in the observed case. Finally, let us assume that the path coefficients  $P_{HT}$ ,  $P_{HX}$ , and  $P_{HY}$  that we have already estimated remain the same after Z is included in the array of independent variables. These three postulates, all quite artificial, suffice to allow us to deduce the path coefficient  $P_{HZ} = .36$  and the corresponding correlation  $r_{HZ} = .50$ . This would appear to be a conservative estimate of the intergenerational correlation of incomes that would have to be postulated to raise the coefficient of determination to the specified level. That is, other reasonable postulates that might achieve the same thing would probably require a still higher value of  $r_{HZ}$ . Now, so far as we know, there is absolutely no evidence on the actual magnitude of such a correlation as  $r_{HZ}$ . But we can note that it is appreciably higher than the other intergenerational correlations we do observe,  $r_{UV} = .40$  and  $r_{YX} = .39$  in this particular age group. The reader may well find it plausible to believe that the intergenerational correlation with respect to income is higher than with respect to occupation and education. If that should prove to be true, it would be slightly surprising, but the possibility certainly cannot be foreclosed.

Even so, it is difficult to imagine that the coefficient of determination for income could be raised without also raising that for, say, education. If family income is a neglected factor in income achievement, we have also neglected it in regard to educational attainment. How much the inclusion of "Z" in the model might raise the coefficient of determination for U is indeterminate without stipulating even more assumptions than we have already used. Hence there really is no way to make a useful hypothetical calculation here. But supposing "Z" made only a very moderate increment in the predictability of U, we would be back to the pattern we have noted in the actual data--to wit, that educational attainment depends somewhat more on family background than does income. As was stated, this conclusion can be only tentative. Nevertheless, it is difficult to shake it on the basis of a priori reasoning alone.

## 4.2. Replication and Scales of Measurement

The work reported in this section takes advantage of the close approximation to a replication of part of the OCG study that was achieved in the Detroit Area Study (DAS) of 1966. The first question raised is that of the transferability of conclusions reached on the basis of a national sample to the situation represented by the population in a particular metropolitan locality. Table 4.2.1 provides the relevant correlations, means, and standard deviations for the two samples. The OCG data used here are for native non-Negro men with nonfarm background in the experienced civilian labor force of the United States in March 1962. The DAS data pertain to native white men 21 to 64 years of age in the summer of 1966. The full DAS sample consisted of 1,013 men; for some combinations of variables the effective sample size is as low as 900 owing to nonresponse on particular items. The comparison of the first two panels in Table 4.2.1, therefore, reveals differences that are due primarily to (a) sampling variation in each of the studies; (b) the difference in time between 1962 and 1966; and (c) the difference in population coverage, national versus local. The coding of occupations, which was accomplished as a special task of the present project, was intended to yield results as nearly comparable as possible with those yielded by procedures of the U.S. Bureau of the Census.

The major result of the comparison is that the intergenerational correlations (V with U, V with Y, X with U, and X with Y) are somewhat lower in Detroit than in the nation, although the intragenerational correlations (V with X and U with Y) are closely similar. This is precisely what we would expect if part of the national intergenerational correlation is due to between-place covariation superimposed upon the within-place covariation found in each of the nation's localities.

Figure 4.2.1 shows diagrams that present the comparison in terms of the path coefficients that can be estimated for the truncated version of the basic model that is, of necessity, used here. (The relevant comparison is between OCG and DAS-1.) For many purposes an analyst might well regard the two sets of results as essentially identical, although it follows from the observation on magnitudes of simple correlations already made that the measured effect of family background on educational attainment and occupational achievement is slightly less in the DAS than in the OCG data. Inasmuch as the OCG sample is far larger in size, coefficients of the same magnitude may be clearly significant in OCG results but not so in DAS results. Thus, on a conventional test,  $p_{YV} = .03$  is clearly significant (greater than two standard errors) in the OCG data, but  $p_{YV} = .05$  is not as large as two standard errors in the DAS data. In both sets of data, of course, this coefficient is at most of marginal substantive interest (the reader may wish to recall the remarks on collinearity in the preceding section).

In summary, it appears that the OCG results, at least in their general configuration, are readily replicated. Although the "news" value of such a result is not great, its scientific importance should

Table 4.2.1.--Simple Correlations in OCG and DAS Data Sets,  
with Alternative DAS Results for Different Measures of  
Occupational Status

Data Set	Variable	Father's Occupation (X or X')	R's Education (U)	R's Current Occupation (Y or Y')	Mean	S.D.
OCG, non-Negro, nonfarm background, age 25-64	Father's educ. (V)	.506	.393	.306	8.63	3.67
	Father's occ. (X)	...	.419	.371	34.07	22.72
	R's educ.(U)	...	...	.610	11.70	3.30
	R's occ. (Y)	...	...	...	43.47	24.58
DAS-1, occupations scored on socio- economic index	V	.481	.322	.271	8.80	3.20
	X	...	.338	.306	33.90	23.76
	U	...	...	.599	12.00	3.20
	Y	...	...	...	45.84	24.03
DAS-2, occupations scored on prestige scale	V	.424	.322	.256	8.80	3.20
	X'	...	.240	.211	39.22	12.78
	U	...	...	.567	12.00	3.20
	Y'	...	...	...	42.74	13.44

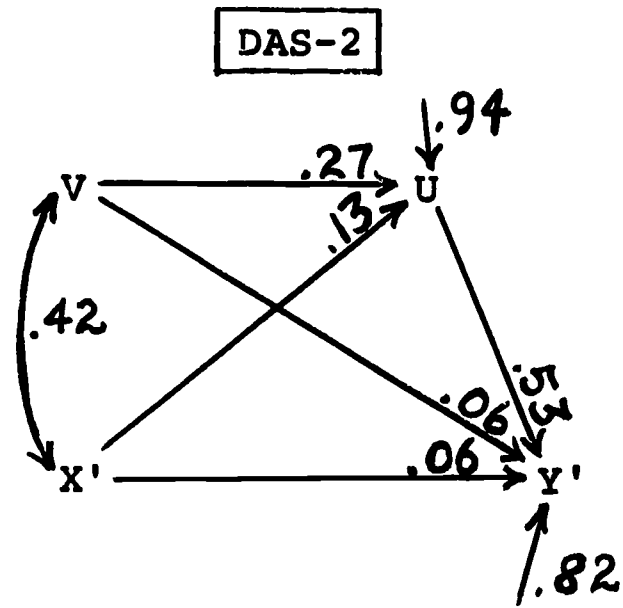
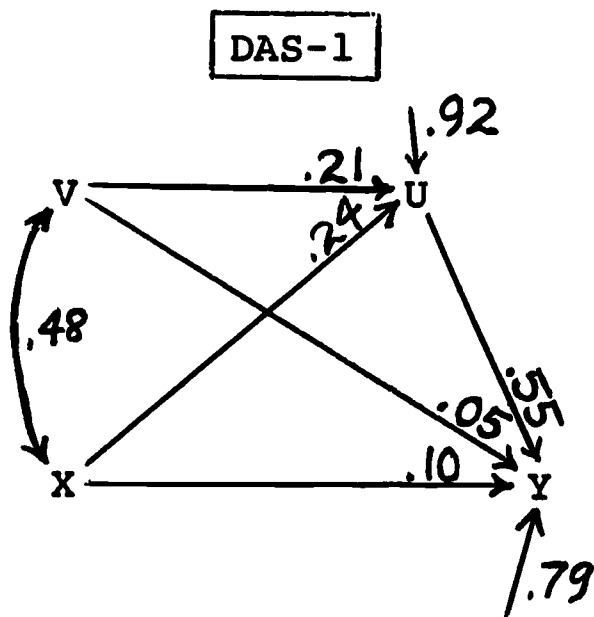
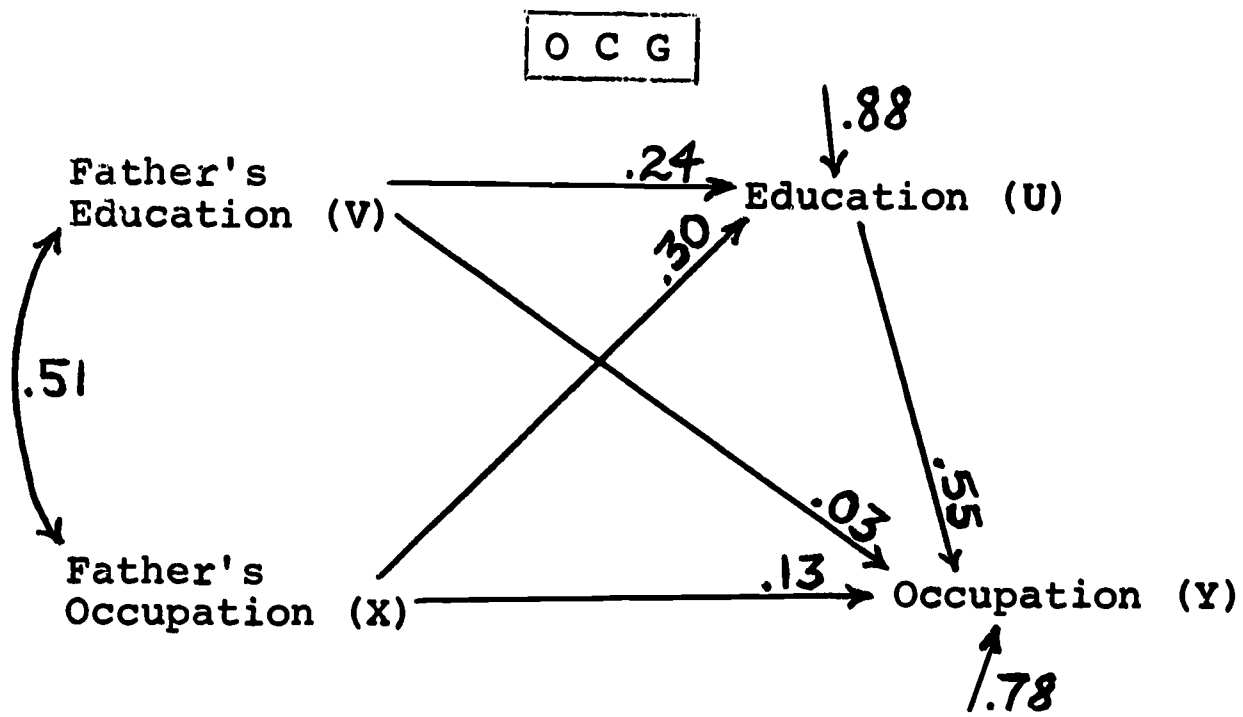

Figure 4.2.1.--Comparison of Results with OCG and DAS Data.  
(Source: Table 4.2.1.)

not be underrated. A minimum requisite for the orderly accumulation of scientific knowledge is that findings of one investigation must recur in other investigations, supposing that sufficient precautions to assure comparability have been taken, as they obviously should be if such accumulation is to occur.

The second set of comparisons afforded by the DAS data has to do with a somewhat different problem. This is the question of how to achieve an operational counterpart to the notion of occupational "status." In all of the work with the OCG data, the measure of occupational status is the socioeconomic index (Duncan, 1961a). In the FGMA data set--to take an example from the material used in this project--the measure was a somewhat different one: the 1947 set of occupational prestige scores, or so-called North-Hatt scale (Reiss, 1961). In the construction of the socioeconomic index, it was found that for the group of criterion occupations the correlation between the two measures was as high as .91 (Duncan, 1961a). However, this calculation probably exaggerates the correlation of the two types of score, for two reasons: first, it is not weighted for the numbers of employed men in each of the occupations; and, second, the correlation applies only to occupations for which a close match between Census and NORC titles was possible.

The consequence of these facts is that comparisons across such data sets as OCG and FGMA are impaired to an unknown degree: similarity of results could be due, in a measure, to mere coincidence, while divergence of results could be due to properties of the measuring instruments rather than to differences between the respective populations.

An opportunity to study the effect of changing the scale of measurement, in abstraction from other factors affecting comparability, was afforded by access to the DAS data. Here we recoded the detailed occupations, which had been initially coded to the census detailed list, in two ways: first, according to the scores on the socioeconomic index, and second, according to a new set of NORC occupational prestige scores generated by recent (and still unpublished) work at NORC by Hodge, Siegel, and Rossi. Results based on the socioeconomic scores are referred to as DAS-1 and those utilizing prestige scores as DAS-2. Thus, in DAS-1 X and Y are measured on the socioeconomic scale, while in DAS-2 X' and Y' are measured on the prestige scale. The correlations between the two scales in the DAS sample are  $r_{XX'} = .814$  and  $r_{YY'} = .860$ . The latter figure probably provides the fairest comparison with the previously mentioned estimate (Duncan, 1961a) of the correlation between the socioeconomic index and prestige, .91. As was indicated, that estimate is somewhat too high.

The comparison of correlations in DAS-1 and DAS-2 (two bottom panels of Table 4.2.1) yields a clearcut result: all the correlations in the latter are smaller than in the former (with the exception, of course, of  $r_{YY'}$  where the occupational measure is not involved). This result has a curious implication. Suppose we wished to think of one of the measures as a "true" occupational status score and the other as a

"fallible" index thereof. Then  $r_{XX'}$  and  $r_{YY'}$  would each be correlations of a true score with a fallible score. Suppose further that we have a certain correlation computed on the basis of fallible scores and wish to estimate what that correlation would be if true scores were known. Straightforward methods for this problem, assuming uncorrelated errors, are available. If, for example, we take it that  $r_{XY} = .306$  is the fallible result, we should then estimate the true correlation as  $r_{X^*Y^*} = (.306)/(.860)(.814) = .437$ . Actually, as Table 4.2.1 shows,  $r_{X^*Y^*} = .211$ . Hence the assumption of this calculation is poorly supported. On the other hand, if we take  $r_{X^*Y^*} = .211$  as the fallible result, we should estimate the true correlation  $r_{XY}$  as  $(.211)/(.860)(.814) = .301$ , an estimate that compares closely with the actual  $r_{XY} = .306$ . Hence, the empirical results in the two versions of the DAS correlations are easier to rationalize on the assumption that occupational socioeconomic status is the "true" measure of occupational status and prestige is a fallible indicator thereof than on the opposite assumption. Of course, we have no warrant for the premise that either of these assumptions must be true, nor can we wholly trust the assumption of uncorrelated errors. But in the light of these results and in view of the desirability of making comparisons with OCG and comparable data, our further use of the DAS data in Chapter 6 will rely solely on the socioeconomic index as the measure of occupational status.

In Figure 4.2.1 the two versions of the DAS data are compared with respect to path coefficients. Two main consequences of substituting  $X'$  and  $Y'$  for  $X$  and  $Y$ , respectively, are noted. First, the overall explanatory power of the model is somewhat less in DAS-2 than in DAS-1, as expected from the simple correlations. Second, use of the occupational prestige measure tends to magnify the importance of father's education, relative to that of father's occupation, in regard to both respondent's educational attainment and his occupational achievement.

It may also be observed that there is a small difference between the two versions in regard to the net influence of respondent's education:  $p_{YU} = .55$  as compared to  $p_{Y'U} = .53$ . The supposition that the socioeconomic index might exaggerate the influence of education on occupational achievement is not, therefore, borne out by this result. A similar conclusion on the point at issue was reached by Blau and Duncan (1967, pp. 124-128) in a somewhat different way. In particular, it will be seen that the magnitude of  $p_{YU}$  relative to  $p_{YX}$  is certainly no greater than that of  $p_{Y'U}$  relative to  $p_{Y'X'}$ . It is to be hoped that this result will effectively satisfy the curiosity of those who have wondered if there is some kind of "education bias" in the socioeconomic index of occupational status.

## CHAPTER 5

### BACKGROUND VARIABLES

In the presentation of the basic model in the previous chapter it has been made clear that family size and socioeconomic level are to be regarded as more or less standard background factors in the analyses described throughout this report. In the present chapter we examine briefly some additional factors that impinge upon life chances by virtue of membership in a given family of orientation. These include what sociologists call the "ascribed statuses" of racial and ethnic group membership. We also look briefly at the question of whether family size is best represented by the simple number of siblings or by numbers of siblings of specified sex. Finally, the possible bearing of the stability of the family of orientation on later fortunes is considered.

With the exception of the matter of the sex of siblings--one which is easily disposed of quickly--the material in this chapter has been dealt with more thoroughly in reports prepared for separate publication. For this reason, and because the work reported in subsequent chapters does not depend closely on the findings reviewed here, the treatment of background factors is abbreviated. This brevity of treatment is not to be construed as an indication of the empirical importance of the factors concerned. On the contrary, we should want to urge that one among these factors represents an extremely significant obstacle to occupational achievement--the factor in question, of course, is membership in a particular "racial" minority group. Aside from demonstrating the severity of the handicap experienced by the individual who is socially classified as "Negro," the analysis shows that all of the measurable influences on achievement are appreciably modified in their effects by membership in this racial category. In statistical terms, race "interacts" with all the other variables in our models. It follows from this that a fully adequate representation of the significance of race would require that all models be separately estimated for whites and Negroes--a requirement that cannot be fulfilled for lack of adequate data. In consequence, most of the work in later chapters is based on data for the white population only, with the explicit recognition of the important gap that this leaves in the investigation.



### 5.1. National Origin

In this section we are using the basic model which was described in the previous chapter, omitting income as an output of the model. Parameters are estimated from the OCG data for native non-Negro men 25 to 64 years of age with nonfarm background. One way to describe the analysis is to state that national origin has been entered into the model as a background factor in addition to the characteristics of the family of orientation (number of siblings and father's occupation and education). The results are summarized in Table 5.1.1; intermediate steps and various details are presented more fully in Report #8.

The first column of Table 5.1.1 shows the "gross effect" of national origin. This is defined as the deviation of the mean occupational score for a particular origin group from the grand mean in the population under study. National origin refers to the country of birth of the father. (In addition to the origins shown here there is a category of "all other" origins that is too small for analysis.) In the whole population under consideration here, the mean occupational score is 43.45, with a standard deviation of 24.58. Thus, the range of national origin group means is from more than one-third of a standard deviation above the general mean (U.S.S.R.) to more than one-half a standard deviation below it (Latin America). There are, then, fairly considerable gross variations among origin groups in occupational achievement. Since the data are confined to men with nonfarm background, rural-urban differences can hardly be the source of these variations.

The "direct effect" (second column of Table 5.1.1) of national origin refers to the coefficient for the particular origin group in a regression of occupational status on education, number of siblings, father's occupation, father's education, and father's country of birth. The model assumes additive effects; for example, that the effects of family characteristics on education and occupation are the same for members of each origin group. It will be noted that the direct effects of national origin are in general smaller than the gross effects (the coefficients cluster more closely around zero). Moreover, the ranking of origin groups is not the same on direct effects as on gross effects. On the former criterion, the greatest advantage is enjoyed by men of north-west European origin (other than Ireland and Germany). The fact that the preponderance of coefficients are positive signifies that the status of second-generation immigrant is not, per se, a handicap with respect to occupational achievement. Such handicaps as men in this status do experience are primarily with regard to social origins in the sense of the socioeconomic status of their families of orientation, which is typically lower than that of men with native fathers.

The third column of Table 5.1.1 shows the effect of national origin on occupational status that operates via education. This is calculated by multiplying the regression coefficient of occupation on education, net of national origin and family characteristics, by the national origin coefficient showing its direct effect on educational attainment,

Table 5.1.1.--Effect of National Origin on Mean Occupational Status, for Native White Civilian Men of Nonfarm Background, Age 25-64, with Foreign Fathers: March 1962

National Origin	Gross Effect*	Direct (Net) Effect	Indirect Effect (via Education)	Due to Social Origins**
U.S.S.R.	8.77	2.83	5.94	0.0
Northwest Europe, except Ireland and Germany	5.55	4.32	0.32	0.91
Ireland	1.03	0.66	2.48	-2.11
Canada	0.89	0.07	0.35	0.47
Germany	0.05	2.56	-1.65	-0.86
Europe, except Northwest, Italy, Poland, and U.S.S.R.	-0.69	1.22	3.27	-5.18
Poland	-4.80	0.28	2.29	-7.37
Italy	-6.03	-1.07	2.25	-7.21
America, except Canada	-14.85	-1.09	-5.12	-8.64

\*Deviation from grand mean for all native civilian non-Negro men with nonfarm background aged 25 to 64.

\*\*Entry in first column less sum of entries in second and third columns.

Source: OCG data, as analyzed in Report #8.

net of the three family characteristics. The sum of the direct and indirect effects of origin represents the influence of origin per se on occupational status, as distinguished from the influence that arises because of the association of national origin with socioeconomic background. The latter, obtained as a residual, is shown in the last column of Table 5.1.1.

The decomposition of origin effects into those that are direct (i.e., net of education as well as family socioeconomic level) and those that are indirect, operating via education, is perhaps suggestive of the mechanisms by which the differentials in achievement come about. The high achievement of men with Russian origin is seen to come about primarily by way of education. By contrast, the northwest European group secures very little advantage by way of superior education (relative to level of social origin), but enjoys comparatively high occupational status relative to its mean educational attainment and socioeconomic background. Men of German and Latin American origin are relatively disadvantaged with respect to education, given their socioeconomic origins; but the German men overcome this handicap while the Latin Americans do not. The latter group is the only one for which both direct and indirect effects are negative; and it is also the one with the least advantageous socioeconomic origins. In these respects it resembles the Negro population, discussed in a later section, although the magnitudes of the effects are much less for the Latin Americans.

The special predicament of the Latin American minority is brought out graphically in Figure 5.1.1. Here the direct and indirect (via education) effects of national origin per se are added together into a single component, and the remainder of the variation associated with national origin is treated as a residual due to differences in socioeconomic level of the family of orientation. The two components are plotted on a scatterdiagram to bring out any possible correlation between them. It will be observed that there is essentially no such correlation, except that produced by the points for the Latin American minority in the lower left corner and the U.S.S.R. group in the upper right.

Some caution should be exercised in detailed pairwise comparisons between countries, in view of the sampling variability in the data. Figures for the Latin Americans, for example, are based on a sample of hardly more than 100 men, while the largest group (Italy) provides a sample of less than 600. In any event, what may be most noteworthy is the comparatively small effects that cannot be attributed to differentials in parental socioeconomic status. It is doubtful that such effects are large enough to sustain complex theories about "national character" or cultural differences in "achievement orientation." By the same token, the data do not confirm the notion of pervasive discrimination based on national origins. For only one group, as previously noted, are both direct and indirect effects observed which might be taken as evidence for both educational and occupational discrimination (if other factors not measured could be assumed equal). In this respect, the

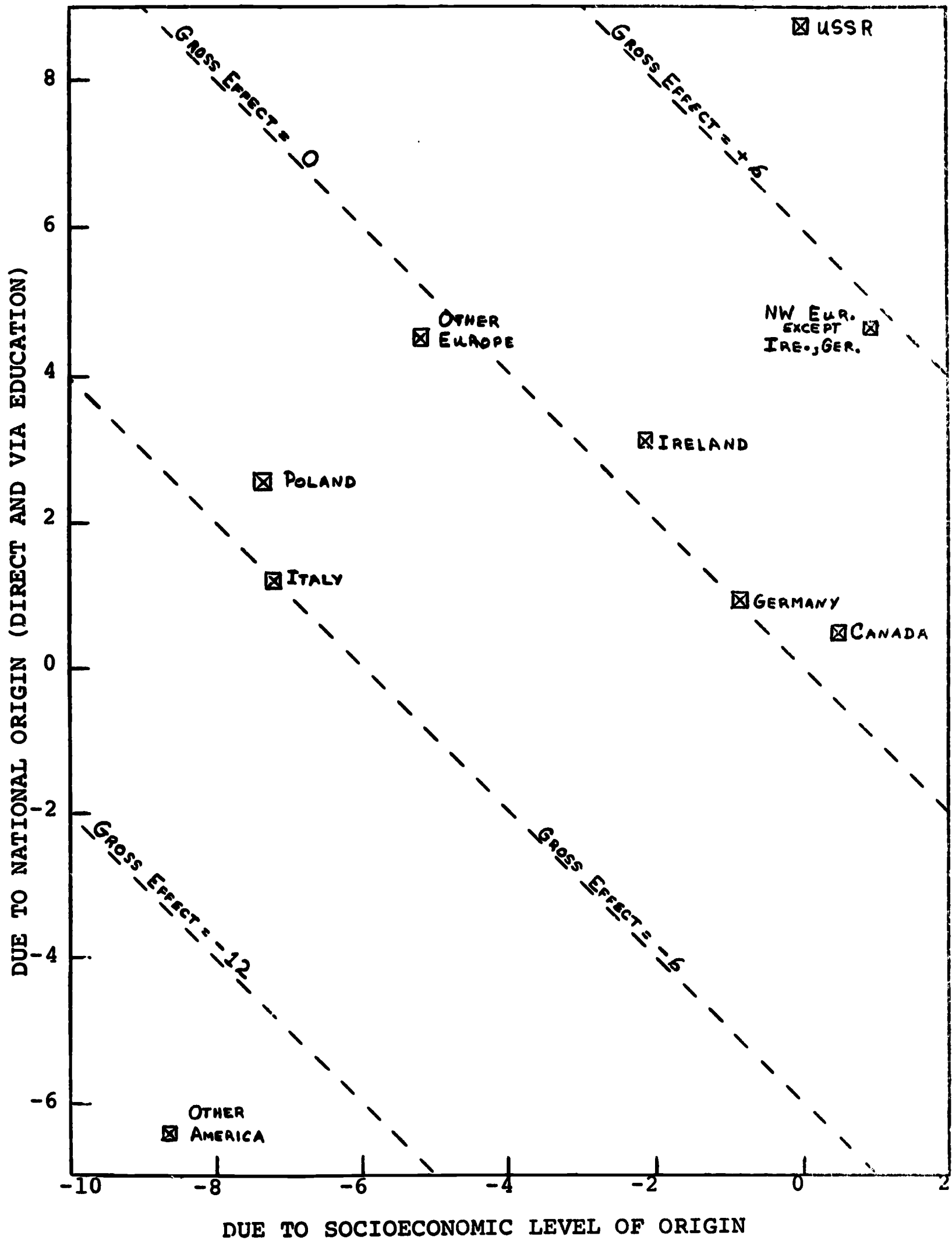

Figure 5.1.1.--Correlation of Two Components of Gross National Origin Effects on Occupational Achievement (see Table 5.1.1).

situation of white ethnic groups is clearly vastly different from that of the Negro-American population, as will become apparent presently.

### 5.2. Race

Two of the separately published reports of this project (#'s 4 and 6) deal in detail with differences between Negroes and whites in occupational achievement. Only a summary of the results is given here.

It requires no new research, of course, to show that Negroes do not enjoy as high a level of occupational status as whites and that they suffer various disadvantages might constitute part of the explanation for differential occupational achievement. What has been lacking in the considerable amount of research published on this topic is an assessment of the extent to which family background can account for racial differentials in occupational achievement. If it were true that white men with comparably disadvantaged family backgrounds did no better in the pursuit of occupational status than the average for Negroes, the racial differential would be "explained" by family background. This, however, is far from being true--a point that has not been fully appreciated by those who diagnose the problems of Negroes as being due in large part to a "culture of poverty."

A beginning in acquiring a more realistic assessment of the situation may be made through study of the intergenerational occupational mobility table (see Table 5.2.1). The size of the OCG sample (roughly 1 in 2,170 of the eligible population) is not large enough to permit a great deal of detail in the occupational classification. The basic relationship we wish to bring out, however, is clear even when broad occupational categories are employed. For any given level of occupational origin (father's occupation), the Negro man is less likely to move into a high status occupation than is a white man with the same level of origin. Thus, quite distinct patterns of intergenerational mobility are present in the two populations. From low origins, white men tend (typically) to move up to higher status jobs; given high origins they tend to remain at a high occupational level. For Negroes, on the contrary, it happens that men with low origins tend to remain at low occupational levels, while those (few) with higher origins tend to fall to low status levels. The typical destination of Negroes, regardless of level of origin, is the lower category of manual jobs. The typical destination for whites, on the contrary, depends on where they originate. Thus, there is an ironic kind of "equalitarianism" in the way the social structure allocates Negroes to occupational pursuits--they typically go into lower manual pursuits, whatever the status of their family of orientation. In the language of regression and correlation used throughout this report, we may summarize by saying that the slope of respondent's occupation on father's occupation is less steep for Negroes than for whites; that the correlation between respondent's and father's occupation is lower for Negroes than for whites; and that

Table 5.2.1.--Transition Percentages, Father's Occupation to 1962 Occupation (Condensed Classification),  
by Race, for Civilian Men 25 to 64 Years Old, March 1962

Race and Father's Occupation*	1962 Occupation*							Total Number (000)
	Higher White Collar (1)	Lower White Collar (2)	Higher Manual (3)	Lower Manual (4)	Farm (5)	NA (7)	Per cent	
<b>NEGRO</b>								
Higher White Collar (1)	10.4	9.7	19.4	53.0	0.0	7.5	100.0	134
Lower White Collar (2)	14.5	9.1	0.0	69.1	0.0	7.3	100.0	55
Higher Manual (3)	8.8	6.8	11.2	64.1	2.8	6.4	100.0	251
Lower Manual (4)	8.0	7.0	11.5	63.2	1.8	8.4	100.0	973
Farm (5)	3.1	3.0	6.4	59.8	16.2	11.6	100.0	1,389
NA (6)	2.4	6.5	11.1	65.9	3.1	11.1	100.0	712
Total, Per Cent	5.2	5.4	9.5	62.2	7.7	10.0	100.0	...
Total, Number (000)	182	190	334	2,184	272	352	...	3,514
<b>NON-NEGRO</b>								
Higher White Collar (1)	54.3	15.3	11.5	11.9	1.3	5.6	100.0	5,836
Lower White Collar (2)	45.1	18.3	13.5	14.6	1.5	7.1	100.0	2,652
Higher Manual (3)	28.1	11.8	27.9	24.0	1.0	7.3	100.0	6,512
Lower Manual (4)	21.3	11.5	22.5	36.0	1.7	6.9	100.0	8,798
Farm (5)	16.5	7.0	19.8	28.8	20.4	7.5	100.0	9,991
NA (6)	26.0	10.3	21.0	32.5	3.9	6.4	100.0	2,666
Total, Per Cent	28.6	11.3	20.2	26.2	6.8	6.9	100.0	...
Total, Number (000)	10,414	4,130	7,359	9,560	2,475	2,517	...	36,455

\*(1) Professional, technical, and kindred workers; managers, officials, and proprietors, except farm.

(2) Sales workers; clerical and kindred workers.

(3) Craftsmen, foremen, and kindred workers.

(4) Operatives and kindred workers; service workers; laborers, except farm.

(5) Farmers and farm managers; farm laborers and foremen.

(6) Father's occupation not reported.

(7) Respondent not in experienced civilian labor force.

Source: OCG data set, as presented in Report #4.

these differences are superimposed upon the lower mean levels of both Negro social origins and achieved occupational statuses.

It is convenient to represent this situation graphically, in order to bring out a point of some methodological importance for subsequent analysis. Figure 5.2.1 portrays the regression of respondent's occupational status on father's occupational status, indicating the distinct regression lines for the white and Negro men. It is easy to see that the white line lies above the Negro line throughout the range of the independent variable, father's occupation, here symbolized by X. Thus the conditional value of Y, given X, as predicted from the regressions, will always be higher for white than for Negro men. Of course, the distributions of individual men around these averages will show some overlap. But the regressions make it quite clear that the factor of father's occupation cannot explain the racial difference in occupational achievement. Or, rather, it appears that this factor can explain only a small part of this difference. Our methodological problem arises in attempting to reach a more precise statement.

The regressions indicate that for Negroes, as for whites, father's occupation makes some difference in level of achievement, even though it makes less difference for the former. We also know that the two groups do differ in regard to mean scores on father's occupation:  $\bar{X}_N = 16.15$  and  $\bar{X}_W = 28.06$ . In what measure can we say that this difference accounts for the difference in respondent's occupational status, having observed that  $\bar{Y}_N = 17.84$  and  $\bar{Y}_W = 39.89$ ? Taking the difference between the two Y-means, 22.05, we have a measure of the "gap" that is to be explained. This gap is represented by the vertical distance between the two horizontal dashed lines in Figure 5.2.1 passing through the white and Negro Y-means respectively. In order to see how much of this gap is due to the difference in mean X-scores, we proceed in a roundabout way to compute, first, how much of the difference remains after removing the difference in mean X-scores.

The difficulty here is that there is no unique answer to the question of how much difference in Y-means remains if we look at a selection of Negro and white men having the same X-scores. Because of the difference in regression slope ( $b_{yx}$ ), which is .47 for whites and only .18 for Negroes, the difference between the Y-values expected for a given value of X increases as X gets larger. There are perhaps two special cases, however, that might seem to provide informative comparisons, if not a unique answer to the question. If we let both Negro and white men have an X-score equal to the mean for all Negro men, the regressions imply a Y-mean of 17.84 for Negroes and one of 34.34 for whites. The difference, 16.50, is represented by component B in Figure 5.2.1; it is the amount by which white occupational status exceeds Negro, on the average, standardizing the two populations for father's occupation at the Negro mean on the latter. There is left a residual amount, A, calculated as  $22.05 - 16.50 = 5.55$ , which represents the part of the total gap which is due to differences in father's occupation. The alternative comparison is to standardize at the white mean on father's occupation.

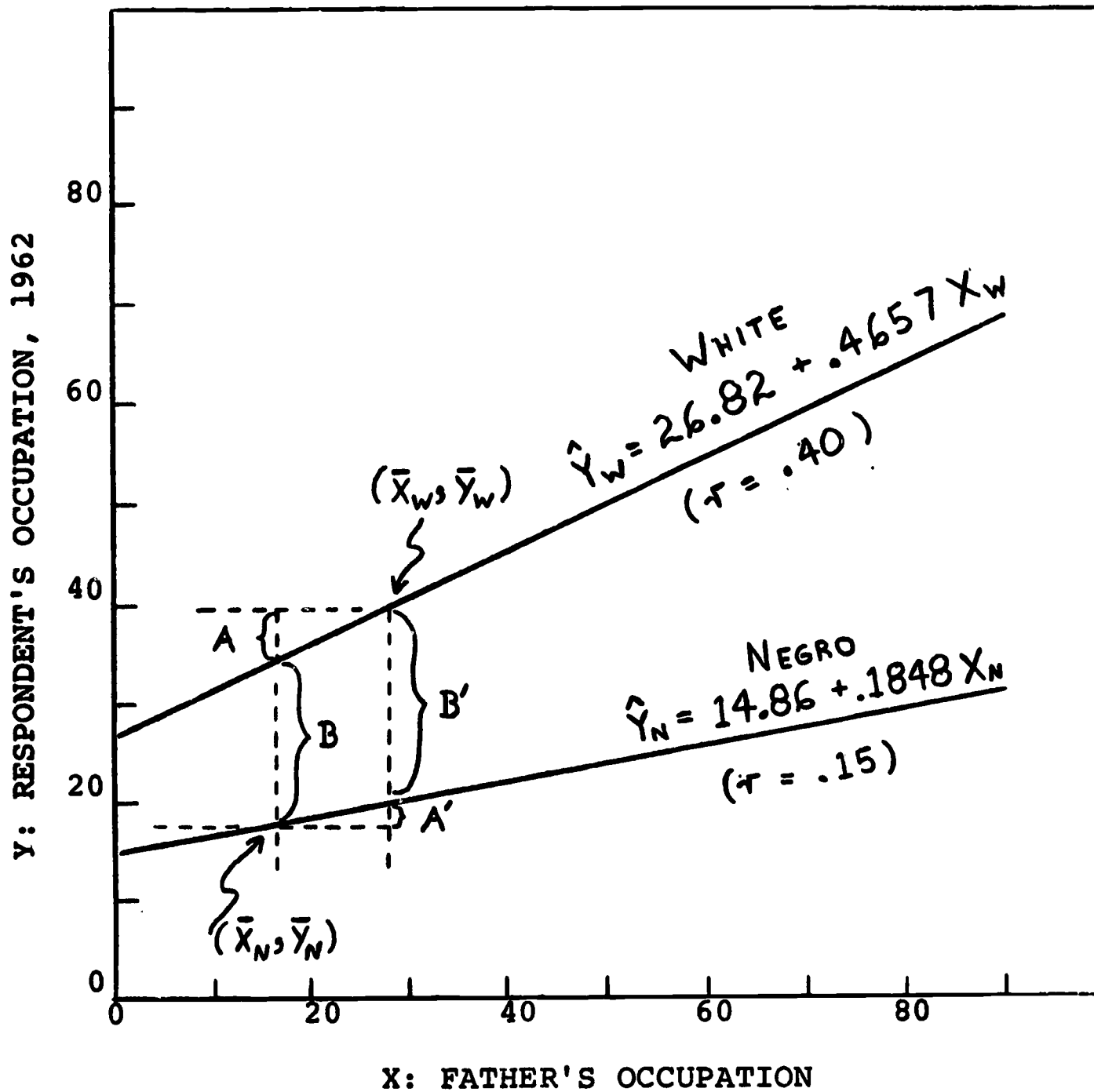

Figure 5.2.1.--Regression of Respondent's Occupational Status on Father's Occupational Status, for Civilian Men 25 to 64 Years Old, by Race: March 1962. (Source: OCG data set.)



At this value of X, the white regression line implies a Y-score of 39.89 while the Negro regression implies 19.85. The difference, labelled as component B' in the figure, is 19.85, leaving  $A' = 2.20$  as the part of the observed gap of 22.05 which is attributable to the racial difference in mean father's occupation. As already noted, alternative evaluations of "B" will differ according to the value of X selected for standardization. We might note, however, that it would not be very meaningful to standardize at a very high X-score, for two reasons: first, few Negroes would be found to have such high scores; and second, the standardization procedure would then put considerable strain on the assumption of linearity of the regressions, although this is not an especially vulnerable assumption in the present case.

In what follows, we shall adopt the first of the two alternatives illustrated above: standardization for background at the Negro mean on background factors. It will be noted that this gives a liberal estimate of the importance of background factors compared to the alternative procedure, given the fact (as is shown in detail in Report #6) that slopes of achieved statuses on background factors are in general lower for Negroes than for whites. Moreover, the procedure adopted here gives a conservative estimate of the magnitude of the racial difference remaining after standardization. If, as one is tempted to do in certain parts of the analysis, this magnitude is taken as an estimate of racial "discrimination," then it is important to bear in mind that the estimates of discrimination generated here are on the conservative side by comparison with alternative estimates that might seem procedurally equally attractive.

The exercise carried out on Figure 5.2.1 in the bivariate context is carried out in the multivariate context in Table 5.2.2. It should be noted that while the material just discussed pertains to all native Negro and non-Negro (essentially white) men 25 to 64 years old, the data in Table 5.2.2 are based only on men with nonfarm background, i.e., those not reporting that their fathers (or other persons serving as head of the family of orientation) were farmers or farm laborers.

The model underlying the calculations is the basic model discussed in Chapter 4, with parameters estimated for non-Negro men 25 to 64 years old. Regression equations in raw score form were computed for these "white" men. Then, Negro means on the explanatory variables were inserted into the white regressions to ascertain what the implied Negro mean on the dependent variable would be if the same regression equation applied for men of both racial categories. This was carried out successively for four dependent variables, number of siblings, educational attainment, occupational status, and income. For each dependent variable, the first estimate equates Negroes and whites for family background (father's occupation and education); then for family background and number of siblings; then for the combination of these plus education; then for all the foregoing plus occupation. We are, therefore, using a sequence of reduced-form regressions to ascertain the contribution of each successive factor to the racial difference in the dependent



variable. This procedure provides components of the "racial gap" with respect to each dependent variable.

Let us take as an example the most elaborate computation, that pertaining to income. The entire racial gap, equal to the difference between observed white and Negro means, is \$3,790. This arises from a white mean of \$7,070 and a Negro mean of \$3,280. Equating Negroes and whites for the two measures of family socioeconomic level implies that the Negro mean income would be \$6,130; so that family socioeconomic level accounts for only  $\$7,070 - \$6,130 = \$940$  of the gap of \$3,790. (So much for the "culture of poverty"!) Similarly, equating for both family socioeconomic level and number of siblings implies a Negro mean of \$6,060; the additional factor accounts for an additional \$70 of the income gap. (So much for the proposal to raise Negroes out of poverty by family-planning measures!) A significant additional component of the income gap, amounting to \$520, is contributed by education, for when Negroes and whites are equated with respect to family socioeconomic level, number of siblings, and education, the implied Negro mean income is \$5,540. (The amount of \$520, presumably, is an estimate of the net payoff, in dollar terms, to a completely successful effort to equalize educational opportunities.) Adding occupation to the battery of prior factors accounts for a further amount of \$830 of the income gap, since equalization on this set of factors implies a mean Negro income of \$4,710. (The component of \$830 may be taken as an estimate of what could be accomplished by elimination of job discrimination, given prior equalization of family background, number of siblings, and education.) Finally, there remains an amount, \$1,430, some three-eighths of the total income gap, which is due to the fact that men in the same line of work, with the same amount of education, the same number of siblings, and the same family socioeconomic background earn different amounts depending on whether they are white or Negro. This is "economic discrimination" in its purest form. But it should be stressed that the several components are cumulative. If one allows \$1,010 as the amount of the gap attributable to family socioeconomic status and number of siblings, this leaves a total of \$2,780 to be attributed to the combination of educational discrimination, occupational discrimination, and economic discrimination.

The detailed explanation we have given of the last column of Table 5.2.2 can be carried through for each of the other columns, although there are successively fewer components for the variables that come earlier in the causal sequence.

It should be stressed that there is no absolute significance to the estimates of the components of racial gaps in educational, occupational, and economic achievement. These estimates are relative to the particular model and the particular population considered. A more elaborate model would allocate the components differently, particularly if some powerful intervening variable could be introduced into it. Similarly, if the estimates were made for a different age group, they would, of course reflect the particular circumstances of the history of that cohort.

It would be possible to offer a lengthy set of comments on the implications of the estimates in Table 5.2.2. It appears that this set of estimates comes closer than any previously published calculations to an operational representation of the notion of "cumulation of handicaps," as this has frequently been discussed in diagnoses of racial differences in this country. It does not seem appropriate here to engage in a presentation of the policy implications of the estimates (see, however, Report #6). Suffice it to say that this demonstration of an extension of our basic model may be one of the most convincing exhibits we can offer of the advantages of adopting a systematic procedure for tracing out the consequences of assumptions as to how a causal process operates.

### 5.3. Number and Sex of Siblings

There is no need for a lengthy discussion of the influence of size of family of orientation on occupational achievement. Our models suggest that the bulk of such influence, which is in the negative direction, operates via educational attainment as an intervening variable. The effect of number of siblings on schooling has been analyzed extensively elsewhere (B. Duncan, 1965; 1967).

As a matter of curiosity, we investigated the possibility that rather than number of siblings as such it might be only the number of brothers or only the number of sisters that has the adverse impact on educational attainment and occupational achievement. The upper diagram in Figure 5.3.1 reports results for a model in which the two variables are both introduced into the causal scheme. It will be noted that the path coefficients for number of brothers are just very slightly higher than for number of sisters. If we compute the reduced form equation with occupation as the dependent variable but with educational attainment eliminated, the path coefficients are  $-.10$  for number of brothers and  $-.08$  for number of sisters.

The lower diagram in the same figure uses the same data to secure estimates for a model in which number of siblings (brothers plus sisters) is regarded as a background factor. There is really no essential difference between the two diagrams. There is no change in the coefficients of determination or in the path coefficients for the other two background factors. Indeed, the two diagrams can be completely reconciled on the viewpoint that number of brothers and number of sisters depend on number of siblings. The correlation between number of brothers and number of sisters is  $.39$ . This correlation is reproduced by the calculation  $(.83)(.84) + (.56)(-1.0)(.54)$ . The correlation of negative unity between the two residuals reflects the tautology that if number of siblings is fixed there is a perfect inverse relationship between number of brothers and number of sisters. It will be found that the lower diagram implies the same correlations between number of brothers and all other variables in the system as does the upper diagram; and the same is true for number of sisters.

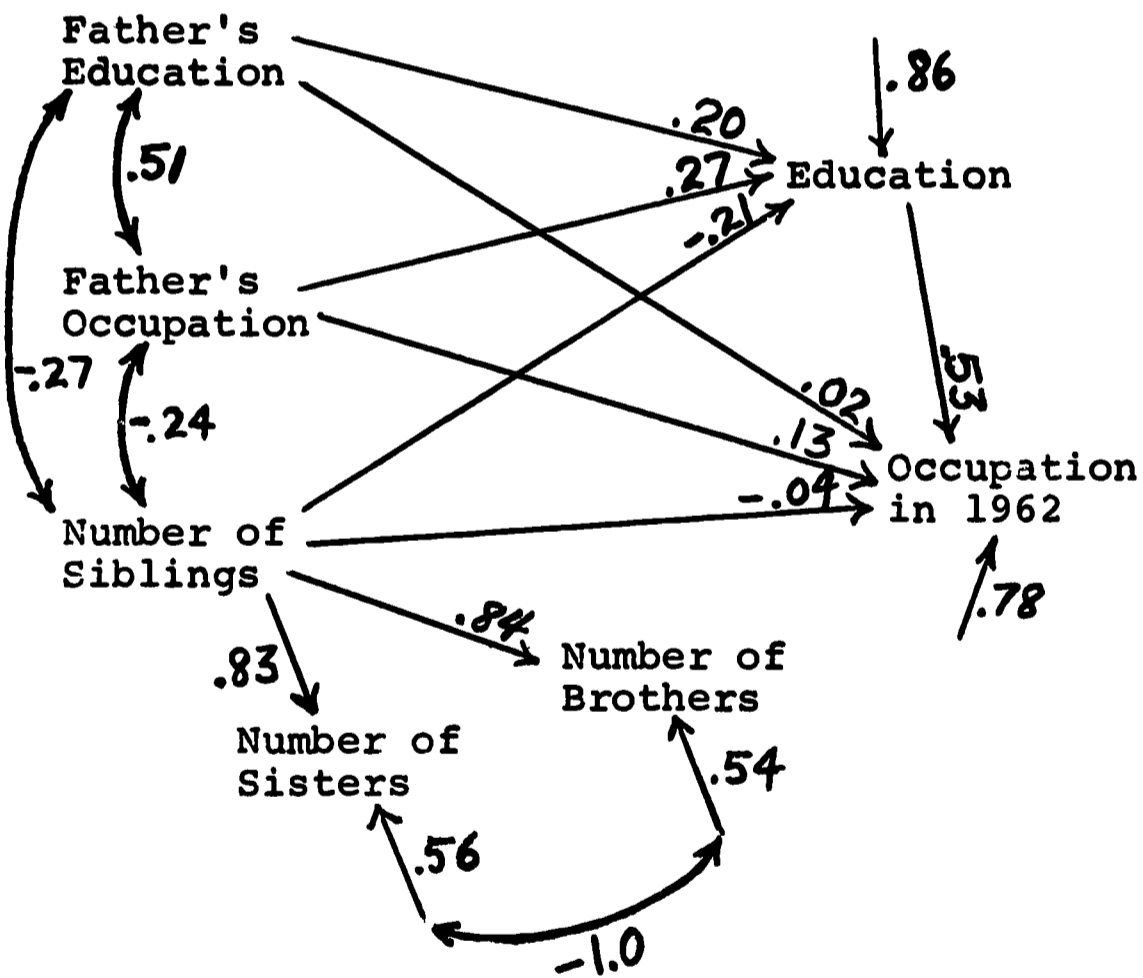
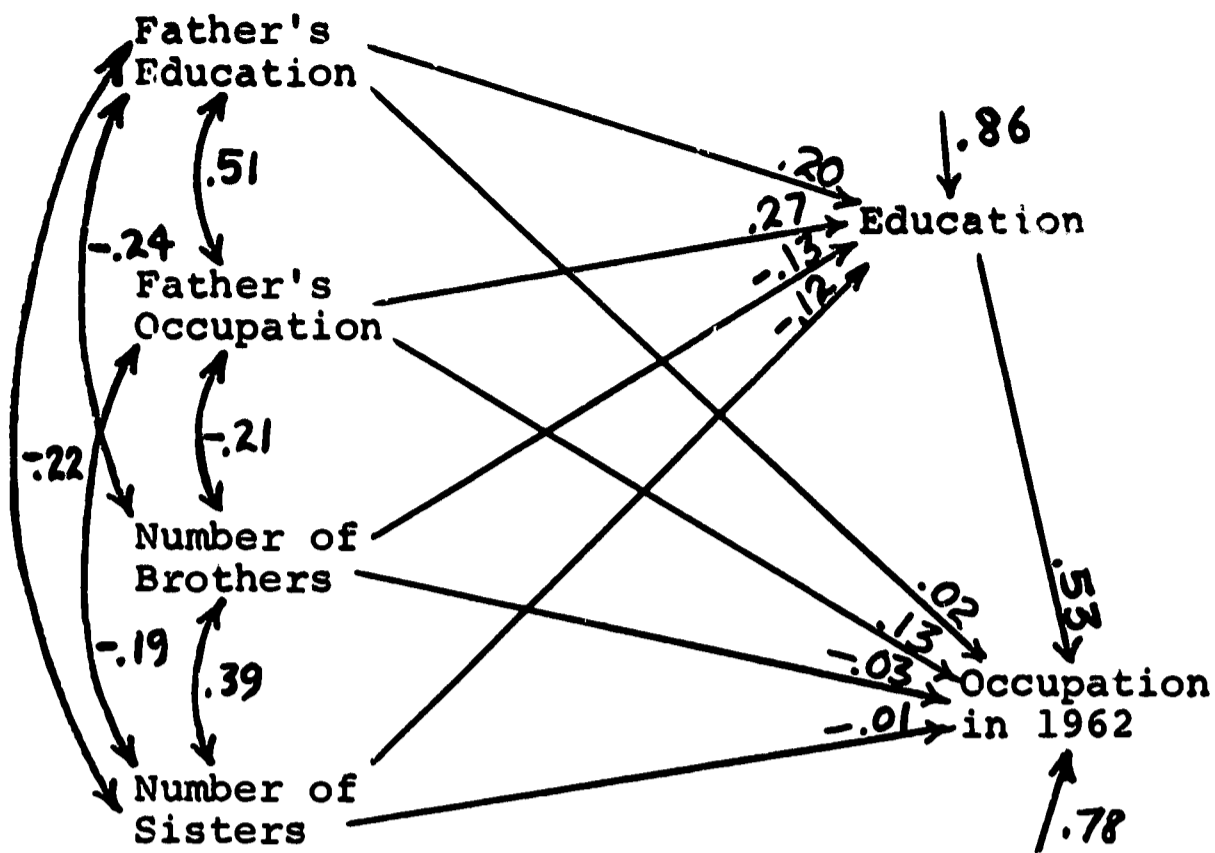

Figure 5.3.1.--Alternative Models Representing Effects of Number of Brothers and Sisters. (OCG data for native non-Negro men with nonfarm background, age 25-64.)

Inasmuch as the apparent difference in strength of effects of number of brothers and number of sisters is trivial while both can be represented adequately if the sex distinction is disregarded, all our other work with the family size variable simply uses number of siblings.

#### 5.4. Family Stability

Previous research (B. Duncan, 1965) closely related to this project included a detailed examination of the influence of the stability of the family of orientation on educational attainment. In that research, OCG respondents were dichotomously classified into those who had grown up in an intact family (father and mother both present) and those who had not. When this factor was considered alone, it appeared that "Growing up in an intact, rather than broken, family resulted in 1.0 years more schooling for a boy" (p. 50). There was, however, appreciable variation in the magnitude of this effect, depending on age and color of respondent. Part of the gross effect of family stability, moreover, was shared with socioeconomic characteristics of the family of orientation that were correlated with its status as intact or broken. Thus, in multiple regressions the net effects of family stability on educational attainment (years of schooling) were as follows, when education of family head, occupation of family head, and number of siblings were taken into account (O. D. Duncan, 1967, Table 2):

<u>Age</u>	<u>Total</u>	<u>White</u>	<u>Nonwhite</u>
27-36	0.7	0.7	0.8
37-46	0.7	0.6	0.7
47-61	1.1	1.2	0.4

The differences between older and younger cohorts suggest an increase in the importance of this factor for nonwhites but a lessening importance for whites, although it is difficult to distinguish true changes from sampling and other errors in this analysis.

In view of the well-known vulnerability of Negro families to disruptive forces there has been a widespread suspicion that racial differences in prevalence of family instability constitute an important part of the explanation of racial differences in occupational and other forms of achievement. Even a cursory analysis, however, suffices to show that no great part of such an explanation can be reached through this factor alone. In the OCG data for native men with nonfarm background, aged 25 to 64, we find that Negroes who grew up with both parents had a mean occupational score in 1962 of 20.67 while those growing up in a family with a female head had a mean score of 18.09; corresponding figures for non-Negro men were 44.40 and 39.25. Thus the gross effect of rearing in a female-headed family, relative to rearing in an intact family, was -2.58 points for Negroes and -5.15 points for whites. These unmistakable yet modest effects are to be contrasted with the effects of race, computed from the same data as 23.73 points in favor of

whites among men growing up in intact families and 21.16 points in their favor for men growing up in a family headed by a female. The latter contrasts are, of course, free of the influence of differentials in family stability and suffice, therefore, to lay to rest any supposition that racial differences in occupational achievement stem primarily from differing experiences of family stability or instability.

A more detailed examination of the relevance of family stability for Negro and white occupational success was carried out in Report #9. The details are rather "messy," and it will be evident from the foregoing summary that the effects being pursued in the analysis are second-order effects rather than primary influences. For the remainder of the work described in this report, therefore, it is not highly relevant to scrutinize this factor closely. Indeed, perhaps the most significant point to make is that as a source of variation in occupational achievement family size is rather more important than family stability, at least in the sense in which it was possible to measure the latter variable in the OCG study.

One other point is of primarily theoretical interest but does serve to specify a little more closely the nature of the handicap bestowed by rearing in a broken family. As noted above, such experience tends to depress educational attainment, net of such other influences thereon as family head's occupation and education and the size of the family of orientation. If we then inquire as to how schooling is translated into occupational achievement, it turns out that, for Negroes in particular, growing up in a female-headed family seemingly impairs a man's ability to realize the occupational return on his education even beyond the degree of such impairment associated with race per se. Thus, in regressions of occupational status on education, in a multiple regression model also including the three socioeconomic background factors already mentioned, the net coefficients are 2.56 points on the occupational scale per year of schooling for Negro respondents who grew up with both parents as compared with 2.13 for those growing up in a family with a female head; corresponding figures for whites are 4.05 and 3.93. Again, it must be emphasized that by far the more profound handicap is that associated with race independent of family status; the effect of the latter relative to the former is clearly of only a second order of importance.

## CHAPTER 6

### INTERVENING VARIABLES, I: INTELLIGENCE

Work with the intervening variable, intelligence, was one of the major preoccupations of the project, extending over much of its duration. This degree of commitment to the task seemed justified, for one main reason, among others. While there is a widely accepted assumption that mental ability is a primary source of variation in occupational achievement--being built into such bodies of practice as vocational counseling and job placement, for example--there is a surprising and distressing lack of information on how ability actually combines with other determinants of success in the world of work. It is difficult to resist offering the suggestion that the imbalance in the state of knowledge and in the collection of relevant information on the topic is due to the fact that it has been left largely to psychologists and practitioners trained in psychology. But if war is too important to be left to the generals, intelligence is so consequential that we cannot rely entirely on psychology to discover its social import.

The contributions of the project on this topic may be listed as follows: a reconsideration of the conceptual relationship between intelligence and occupational status; a review of sources of reliable evidence on the correlation of measured mental ability with variables implicated in the process of achievement; and the construction of a model to represent the role of intelligence in that process. The final results on the last item are presented in detail in Report #3, and will only be summarized here; a somewhat lengthier treatment is given of the other two topics and of certain preliminary investigations carried out before constructing the final model.

#### 6.1. Observations on the Concept of Intelligence

As an entry into the problem let us summarize an exercise that may have more than an antiquarian interest. At one time there was rather wide use of a scale, purportedly measuring the standing of occupations, which was devised in the early 1920's. The Barr scale is briefly described in Volume I of Genetic Studies of Genius (Terman, 1925, p. 66): "Mr. F. E. Barr drew up a list of 100 representative occupations, each definitely and concretely described, and had 30 judges rate them on



a scale of 0 to 100 according to the grade of intelligence which each was believed to demand. The ratings were then distributed and P.E. values were computed for all the occupations. The P.E. values express in the case of each occupation the number of units of intelligence which, according to the composite opinion of these 30 judges, the occupation demands for ordinary success." The listing of the occupations, with their descriptions and P.E. values, is reproduced in Table 6.1.1. (Note that there are actually 120 titles in the list.)

Socioeconomic status scores (Duncan, 1961) are available for entries in the list of detailed occupations given in the 1960 Census of Population: Classified Index of Occupations and Industries. Each occupation has a two-digit score ranging from 00 to 96 which was computed on the basis of 1950 census data on income and education levels prevailing in the occupations. Prestige ratings are available for a group of occupations included in a 1964 study (as yet unpublished) by Hodge, Siegel, and Rossi at the National Opinion Research Center (NORC). The unpublished NORC list indicates the matching detailed census occupation title, with an indication as to the quality of the match.

The initial task was to match as many as possible of the Barr scale titles with the census titles and with NORC titles. No attempt was made to match NORC titles with census titles directly since NORC had already done this. Having arrived at two sets of titles that were assumed to match, the correlations between the Barr scores and the socioeconomic scores and between the Barr scores and the NORC scores were obtained.

The descriptions included with most of the occupation titles in the Barr scale were not always the most helpful in determining a match with one of the other two listings. In some cases the descriptions were such that no match was possible, e.g., "Surgeon (Mayo Bros.)," and these titles were deleted. (One wonders what "ordinary success" as a Dr. Mayo might be.) Of the remaining 112 titles, some were combined using an arithmetic average as indicated in Table 6.1.1 to facilitate a match. In deciding upon matches, seven descriptions were thought probably to bias anyone reading the description so that he would think of only a certain small segment of the workers included under that title, and that this small segment would not be typical. Such an example would be the title Chef, with the description "Employed in large first-class hotels." A third group of eleven Barr scale titles contained descriptions that were thought possibly to bias a person reading a description. For instance, the title Pharmacist, with a description of "In town from 1000-5000 population," in which case the size of the town was thought possibly to bias a person's judgment as to the amount of intelligence needed to perform the job. There were sixty-four Barr scale titles for which the description was thought not to influence a person's judgment in a biasing way. These were subdivided into two groups. One group contained thirty Barr scale titles with nonbiased descriptions and with a high quality NORC-census match; the other group contained thirty-four Barr titles with nonbiased description but with only a Census match.

Table 6.1.1.--Barr Rating, Occupation Title, and Description, with Matching Group Socioeconomic Status Score (SES) and NORC Prestige Rating for Occupations Included in Barr Scale (See text for sources)

P.E. Value	Occupation	Description	Group	SES	NORC	Note
0.00	Hobo	--	(omit)	...	...	...
1.54	Odd jobs	--	2	...	...	(a)
2.11	Garbage collector	--	2	...	...	(a)
3.38	Circus roustabout	Does heavy, rough work about the circus	2	...	...	(a)
3.44	Hostler	Care of horses in livery, feed and sales stables	2	...	...	(a)
3.57	R. R. Sec. Hand	Replaces ties, etc., under supervision	2	03	22.20	(a)
3.62	Day laborer	On street, in shop or factory as roustabout	2	...	...	(a)
3.99	Track layer	Does heavy work under supervision	2	...	...	(a)
4.20	Waterworks man	A variety of odd jobs, all unskilled	5	21	...	...
4.29	Miner	Digger and shoveller, etc.	1	10	24.32	...
4.81	Longshoreman	Loads and unloads cargoes	1	11	26.86	...
4.91	Farm laborer	Unskilled and usually inefficient	3	06	21.36	(b)
4.98	Laundry worker	Various kinds of work in laundry (practically unskilled)	2	15	19.01	...
5.27	Bar tender	--	1	19	19.86	...
5.41	Teamster	--	2	...	...	(c)
5.44	Sawmill worker	Heavy work, little skill required	2	05	30.75	...
5.59	Dairy hand	Milking, care of stock under supervision	3	...	...	(b)
5.81	Drayman	--	2	...	...	(c)
5.87	Deliveryman	Delivers groceries, etc., with team or auto	2	32	...	...

Table 6.1.1.--(CONTINUED)

P.E. Value	Occupation	Description	Group	SES	NORC	Note
6.14	Junkman	Collector of junk	5	59	...	...
6.42	Switchman	Tending switch in R.R. yards	1	44	32.78	...
6.66	Smelter worker	Metal pourers, casting collectors, etc.	2	18	...	...
6.27	Tire repairer	In general automobile repair shop	5	08	...	...
6.85	Cobbler & shoemaker	Repairman in shoe shop	2	12	...	...
6.86	Munition worker	Average	5	08	...	...
6.92	Barber	Not owner. Has charge of chair	1	17	37.93	...
6.93	Mov. picture operator	Operates machine which projects pictures	2	43	...	...
7.02	Vulcanizer	Understands the process of hardening rubber	5	22	...	...
7.05	General repairman	Repairs broken articles. Uses wood-working tools.	5	19	...	...
7.06	Ship rigger	Installing cordage system on sailing vessels, working under supervision	5	32	...	...
7.17	Telephone operator	--	1	45	40.36	...
7.19	Cook	In restaurant or small hotel	1	15	25.97	...
7.23	Streetcar conductor	--	2	30	...	...
7.24	Farm tenants	On small tracts of land	2	14	21.52	(e)
7.30	Brakeman	On freight or passenger trains	1	42	34.65	..
7.33	City fire fighter	Handles the ordinary fire-fighting apparatus	1	37	43.81	...
7.39	R.R. fireman	On freight or passenger train	2	45	...	...
7.54	Policeman	Average patrolman	1	40	47.77	...

Table 6.1.1.--(CONTINUED)

P.E. Value	Occupation	Description	Group	SES	NORC	Note
7.71	Structural steel worker	Heavy work demanding some skill	2	34	...	...
7.73	Tel. & tel. lineman	--	2	49	...	...
7.77	Bricklayer	--	1	27	35.66	(d)
7.79	Butcher	Not shop owner. Able to make cuts properly	1	29	32.12	...
7.91	Baker	--	1	22	34.18	...
8.02	Metal finisher	Polishes and lacquers metal fixtures, etc.	2	22	...	...
8.04	Plasterer	Knowledge of materials used necessary	2	25	...	...
8.08	General painter	Paints houses, buildings and various structures	1	16	29.78	...
8.22	Harness maker	--	5	32	...	...
8.40	Tinsmith	Makes vessels, utensils, etc., from plated sheet metal	2	33	...	...
8.49	Letter carrier	--	1	53	44.66	
8.50	Forest ranger	--	2	48	...	...
8.58	Stone mason	--	1	...	...	(d)
8.75	Plumber	Av. trained plumber employee	1	34	40.58	...
8.89	Gardening, truck farming	Owns and operates small plots	2	...	...	(e)
8.99	Electric repairman	Repairs elec. utensils, devices and machines	5	27	...	...
9.28	Bookbinder	Sets up and binds books of all sorts	2	39	...	...
9.37	Carpenter	Knows wood-working tools. Can follow directions in various processes of wood construction work	1	19	37.33	...

Table 6.1.1.--(CONTINUED)

P.E. Value	Occupation	Description	Group	SES	NORC	Note
9.37	Potter	Makes jars, jugs, crockery, earthenware, etc.	2	21	...	...
9.54	Tailor	Employee in tailoring shop	2	23	...	...
9.72	Salesman	In drygoods, hardware, grocery stores, etc.	2	39	27.13	...
10.11	Telegraph operator	In small town	3	47	...	...
10.21	Undertaker	In small town. Six mo.-yr. special schooling	1	59	53.40	...
10.26	Station agent	In small town. Acts as baggage man, freight agent, operator, etc.	3	60	...	...
10.26	Mechanical repairman	In shop or factory. Keeps machines in condition	2	27	...	...
10.29	Dairy owner and mgr.	Small dairy, 50-100 cows	2	...	...	(e)
10.53	Metal pattern maker		2	...	...	(f)
10.54	Wood pattern maker		2	44	...	(f)
10.54	Lithographer	Makes prints from designs which he puts on stone	2	64	...	...
10.76	Linotype operator		2	52	...	...
10.83	Photographer	City 1000-5000. A few months' training, experience in studio	3	50	...	...
10.86	Detective	Traces clues, etc. Employee of detective bureau	2	36	...	...
10.99	Electro-typer	Prepares wood cuts	2	55	...	...
11.17	Traveling salesman	Sells drugs, groceries, hardware, drygoods, etc.	2	47	41.53	...
11.34	Clerical work	Bookkeepers, recorders, abstractors, etc.	1	51	47.56	...

Table 6.1.1.--(CONTINUED)

P.E. Value	Occupation	Description	Group	SES	NORC	Note
11.35	R.R. Pass. conductor		1	58	40.86	...
11.51	Store keeper & owner	Small town retail dealer general or special store	1	33	46.07	...
11.74	Foreman	Small factory, shop, etc.	1	53	45.05	...
11.78	Stenographer	Writes shorthand and uses typewriter	1	61	43.34	...
12.02	Librarian	In small institution or public library	3	60	54.58	...
12.06	Nurse and masseur	Graduate	1	46	61.51	...
12.74	Chef	Employed in large first-class hotels	4	15	...	...
12.84	Editor	Small paper, considerable job work	4	82	...	...
12.89	Primary teacher	No college training, 2 yrs. special training	3	...	...	(g)
12.96	Landscape gardener		2	11	...	...
13.08	Grammar grade tchr	Normal graduate expects to make profession teaching	3	72	60.08	(g)
13.20	Osteopath	Training equal to college graduate	2	96	...	...
13.21	Pharmacist	In town of from 1000-5000 population	3	82	60.75	...
13.29	Master mechanic	Thorough knowledge in his field of mechanics	5	27	...	...
13.30	Music teacher	2-4 yrs. special training, not college graduate	4	...	...	(h)
13.31	Manufacturer	Employs from 10-50 men. Makes simple articles.	2	61	65.16	...
13.54	Dentist	Graduate. 2-5 yrs. experience in small town	3	96	...	...
13.58	Art teacher	In high school. 3 or 4 years' special training	4	67	...	...
13.71	Surveyor	Transit man. City or county surveyor	1	48	53/27	...

Table 6.1.1.--(CONTINUED)

P.E. Value	Occupation	Description	Group	SES	NORC	Note
13.31	Train dispatcher	Must be mentally alert	5	71	...	...
14.45	Land owner & operator	Very large farms or ranches	2	...	...	(e)
14.70	Musician	Successful player or singer in good company	4	52	14.70	(h)
15.05	Secretarial work	Private secretary to high state or national officials	4	61	...	...
15.14	High school teacher	Coll. or Normal grad. Not the most progressive	3	72	63.11	...
15.15	Preacher	Minister in town of 1000-5000. College graduate	3	52	68.99	...
15.42	Industrial chemist	Thorough knowledge of the chem. of mfg. processes	2	79	...	...
15.43	Mechanical engineer	Designs and constructs machines and machine tools	2	82	...	...
15.71	Teacher in college	Degree A.B. or A.M. Not the most progressive	3	84	78.26	...
15.75	Lawyer	In town of moderate size. Income \$1000-\$5000	1	93	75.66	...
15.86	Technical engineer	Thorough knowledge of the processes of an industry	2	...	...	(i)
16.18	Artist	High class painter of portraits, etc.	4	67	...	...
16.26	Mining engineer	Thorough knowledge of mining and extraction of metals	1	85	61.61	...
16.28	Architect	Training equal to college graduate	1	90	70.52	...
16.58	Great wholesale merchant	Business covering one or more states	5	70	...	...
16.59	Consulting engineer	In charge of corps of engineers	2	...	...	(i)
16.64	Educational administrator	Supt. city 2000-5000 Coll. or Normal graduate	5	72	67.40	...

Table 6.1.1.--(CONTINUED)

P.E. Value	Occupation	Description	Group	SES	NORC	Note
16.71	Physician	6-8 yrs. prep. above H.S. Income \$5000 and up	1	92	81.55	...
16.91	Journalist	High class writer or editor	4	82	58.83	...
17.50	Publisher	High class magazine and newspaper or periodical, etc.	5	79	...	...
17.81	University professor	Has A.M. or Ph.D., writes, teaches, and does research	1	84	78.26	...
18.06	Great merchant	Owens and operates a million dollar business	(omit)	...	...	...
18.14	Musician	(Paderewski)	(omit)	...	...	...
18.33	High Nat'l official	Cabinet officers, foreign ministers, etc.	(omit)	...	...	...
18.85	Writer	(Van Dyke)	(omit)	...	...	...
19.45	Research leader	Like Binet or Pasteur	(omit)	...	...	...
19.73	Surgeon	(Mayo Bros.)	(omit)	...	...	...
20.71	Inventive genius	(Edison type)	(omit)	...	...	...

Notes (P.E. Values for Combined Titles):

- (a) 3.09 Odd jobs, Garbage collector, circus roustabout, hostler, R.R. section hand, day laborer, track layer (Group 2)
- (b) 5.25 Farm laborer, dairy hand (Group 3)
- (c) 5.61 Teamster, drayman (Group 2)
- (d) 8.18 Brick layer, stonemason (Group 1)
- (e) 10.22 Farm tenants (gardening, truck farming), dairy owner and manager, landowner and operator (Group 2)
- (f) 10.54 Metal pattern maker, wood pattern maker (Group 2)
- (g) 12.99 Primary teacher, Grammar grade teacher (Group 3)
- (h) 14.00 Music teacher, musician (Group 4)
- (i) 16.23 Technical engineer, consulting engineer (Group 2)



A final group of Barr scale titles consisted of fourteen titles with remote Census matches without regard to the bias effect of the description. Thus, five groups of titles were obtained as follows:

- Group 1: 30 titles with good Barr-Census-NORC matches and nonbias descriptions.
  - Group 2: 34 titles with Barr-Census matches and nonbias descriptions but no NORC match.
  - Group 3: 11 titles with Barr-Census matches having possible bias descriptions, and which may or may not have an NORC match.
  - Group 4: 7 titles with Barr-Census matches having probable bias descriptions, and which may or may not have an NORC match.
  - Group 5: 14 titles with remote Barr-Census matches which may or may not have NORC matches and/or biased descriptions.
- Total 96 titles.

An analysis of covariance was made, with the five groups named above as the "treatment variable"; the socioeconomic status scores as the independent variable; and the Barr scale scores as the dependent variable. The five groups of titles were examined to determine if a common slope prevailed, whether the slope differed from zero, and whether one regression line would fit all groups.

The results, seen in Table 6.1.2, of the three appropriate F-tests suggest that there is a common slope, that it is not equal to zero, and that one regression will fit all five groups. Since one regression line will fit all groups, it seems that our worries about bias descriptions and remote matches are without grounds. Thus, the five groups can be combined, and the ninety-six matches obtained can be used in further analysis of Barr-Census comparisons.

Table 6.1.2.--F-Tests for Covariance Analysis

Test	N <sub>1</sub> d.f.	N <sub>2</sub> d.f.	Observed F-value	P	Table F-value for given P	Result
Common slope	4	86	2.20	.95	2.47	Accept
Slope = 0	1	86	143.78	.99	6.94	Reject
One regression line fits all groups	4	90	2.37	.95	2.47	Accept

A similar analysis could have been carried out for the Barr-NORC matches as well, but with the above conclusions and a look at the scatter plot for the Barr-NORC matches, it was concluded that there was no need for eliminating any of the Barr-NORC matches. In total there are forty-seven Barr-NORC matches, consisting of the thirty that also have "good" census matches according to NORC, and seventeen additional ones that are thought to have a lower quality match with the census.

The principal results of the foregoing analysis are: (1) The ninety-six Barr-Census title matches reveal a correlation between the Barr scale scores and socioeconomic scores of .81. (2) The forty-seven matches of titles of the Barr scale with NORC titles have a correlation of .91 between Barr scale scores and NORC prestige scores. For these 47 titles the correlation between Barr scores and socioeconomic scores is .90; between socioeconomic and prestige scores, likewise .90.

The purpose of this analysis, of course, was not to ascertain how the "intelligence" of individuals is actually related to the prestige or socioeconomic status of the occupations they pursue. (This topic will be discussed presently.) Instead, we wished to substantiate a point for future reference: the psychologist's concept of the "intelligence demands" of an occupation is very much like the general public's concept of the prestige or "social standing" of an occupation. Both are closely related to independent measures of the aggregate social and economic status of the persons pursuing an occupation. In short, we suggest here, with the intention of elaborating the idea below, that "intelligence" is a socially defined quality and this social definition is not essentially different from that of achievement or status in the occupational sphere. It is no mere coincidence, therefore, when psychologists find that "the kinds of occupational criteria which intelligence tests predict best are measures of the complex status characteristic we call occupational levels" (Tyler, 1964, p. 176).

None of these results, of course, resolves the ancient question of what intelligence "really is," or of the degree to which intelligence is actually required for the performance of occupations varying in social status or prestige. Yet it is surely significant that the preconceptions of psychologists about occupational performance in relation to intelligence--which preconceptions presumably are built into conventional intelligence tests--so closely coincide with the public's view of the social worth or standing of occupations. If, as sociologists believe, the occupational role is a central element in the structure of a differentiated society, the abilities required for satisfactory performance of that role must be fairly directly involved in the achievement of occupational status.

It is not utterly fanciful to reconstruct the history of intelligence testing in a way that it is seldom presented. As we usually think of the matter, psychologists analyzed mental functions and then abstracted a component, "intelligence," which they took to be a general factor in the relative efficiency of human organisms. They then devised

tasks apparently requiring this factor in various degrees, and incorporated them into standard sets called "intelligence tests." Once such tests were administered to population samples, it was discovered that they were predictive of the amount of success in school and work people would enjoy.

The reconstruction we wish to suggest is the following. Every society implicitly designates certain key roles in which performance is variable, with the quality of the performance being a basis for the assignment of status. (Other statuses, of course, may depend upon factors besides performance--the so-called ascribed statuses.) Where the society is one with a complex division of labor, many differentiated occupations are pursued, and these occupations are highly salient among the key roles whose pursuit is a basis for status achievement. Adequate performance in a high status occupation is taken by the social group as *prima facie* evidence of social capability. On the other hand, poor performance in a high status occupation leads to uncertain tenure of the status, and performance--whether good, bad, or indifferent--of a low status occupational role is not seen as providing any sizeable increment to consensual estimates of a person's value to society. What we call "occupational prestige" corresponds to an unmistakable social fact. When psychologists came to propose operational counterparts to the notion of intelligence, or to devise measures thereof, they wittingly or unwittingly looked for indicators of capability to function in the system of key roles in the society. What they took to be mental performance might equally well have been described as role performance. Indeed, the pioneers of mental testing were clear in their own minds that they wished to tap capacity to perform well in another social situation--that of the school. For their immediate purposes, it was unnecessary to expand upon the sociological observation that the school is itself (among other things) a primary mechanism for selecting incumbents of occupational roles.

Our argument tends to imply that a correlation between IQ and occupational achievement was more or less built into IQ tests, by virtue of the psychologists' implicit acceptance of the social standards of the general populace. Had the first IQ tests been devised in a hunting culture, "general intelligence" might well have turned out to involve visual acuity and running speed, rather than vocabulary and symbol manipulation. As it was, the concept of intelligence arose in a society where high status accrued to occupations involving the latter in large measure, so that what we now mean by intelligence is something like the probability of acceptable performance (given the opportunity) in occupations varying in social status.

This argument, however, does not imply that the correlation of IQ with occupational status--assuming the latter to be measured on a scale of prestige or (what is nearly equivalent) socioeconomic rank--will be perfect. First, there are many social contingencies (just alluded to by the term "opportunity") which may militate against a matching of capacity to perform occupational roles and actual performance.

Second, any test is a small sample of the almost unlimited sorts of personal assessments that could be made; it is thus a fallible basis of inference.

It is an empirically contingent question, therefore, as to how well occupational achievement can actually be predicted from test scores. If our argument were entirely cogent, we might suppose that if all the "social contingencies" bearing upon occupational achievement were properly taken into account, residual variation would be solely due to "intelligence." To accomplish a demonstration of this hypothesis, however, we should require a model that correctly locates intelligence itself in a causal complex and correctly specifies its role in status achievement vis-à-vis the many other contingent factors. One way of stating our purpose in this research is to indicate that we are trying to make progress in this direction. Naturally, we do not expect any such decisive result as that suggested by the statement of the ultimate objective of research.

### 6.2. Correlates of Intelligence

In a search for psychological data on sizeable populations which could be roughly matched with our demographic data on occupational achievement, we were pleasantly surprised to learn of a very substantial body of information summarized by Byrns and Henmon (1936). They report scores of some 100,000 Wisconsin high school seniors given selected tests of "scholastic aptitude" during 1929-33. The summary is in terms of 10 broad groups of parental occupation and 77 specific occupation titles. Three different tests had been used, so the authors aggregated the results only after making a percentile transformation. Their Table V shows for each of the 77 parental occupations the number of students tested, and the first, second, and third quartile scores of students identified with that parental occupation.

Our interest was in the correlation of students' scores with the status of the parental occupation as measured by Duncan's (1961a) socio-economic index of occupational status. To study this correlation, we had to match the occupation titles given by Byrns and Henmon with the census titles for which the index is defined. This led us to make certain omissions, such as students whose parents were "retired" or classified in a "miscellaneous" category. We also omitted a few occupations, containing only a small number of students, where the title strongly suggested exclusive application to the female parent, e.g., "nurses" and "dressmakers." Altogether, we retained the data pertaining to 88,883 of the original 100,820 students. In some instances we had to make a combination of two titles given by Byrns and Henmon to achieve approximate comparability with a census category, and sometimes census titles had to be combined. We ended up with 64 occupation titles for use in our re-study of Byrns and Henmon's data. The process of matching occupation titles is inevitably somewhat arbitrary and subjective, but in the light of our experience it is difficult to believe that the results would have been greatly different in the hands of any knowledgeable investigator.

For future use, however, we offer to psychologists the suggestion that their data could be more generally useful if some care were taken to render occupation and other social categories consistent with those employed in official statistical sources.

One further manipulation was required before we could compute the statistics of interest to us. Since Byrns and Henmon used percentiles as their score values, they obtained a roughly rectangular distribution of scores--approximately 10 per cent being scored 0-9, 10 per cent 10 to 19, and so on, to 10 per cent in the top interval, 90-100 (see their Table I). We assumed the underlying score distribution was normal, and converted the median percentile scores in their Table V to normal deviates--or, actually, to probits, making use of Table IX in Statistical Tables for Biological, Agricultural and Medical Research, by R. A. Fisher and F. Yates (3d. ed., London: Oliver & Boyd, 1948). The probit values were then transformed to standard scores with mean 100 and standard deviation 20. For example, Byrns and Henmon report that children of Druggists had a median percentile score of 67.6. In the normal distribution 67.6 per cent of the population falls below a score corresponding to .4565 standard deviation units above the mean or a probit value of 5.4565. This probit value multiplied by 20 is 109.13, which (rounded to 109) we took to be the mean standard score of children of Druggists.

Let  $X_j$  be the occupational status score of the  $j$ th occupation on Duncan's scale,  $\bar{Y}_j$  be the mean standard score of children of parents classified in the  $j$ th occupation, and  $n_j$  the number of such children in the data of Byrns and Henmon, so that  $\sum n_j = N = 88,883$ . If  $Y_{ij}$  is the standard score of the  $i$ th child in the  $j$ th occupation category, we have

$$\bar{Y} = \frac{\sum_j \sum_i Y_{ij}}{N} = \frac{\sum_j n_j \bar{Y}_j}{N} = 100.607,$$

differing slightly from 100, presumably because of the omissions noted above and/or errors of rounding. By assumption,

$$\text{Var}(Y) = \sigma_Y^2 = 20^2 = 400,$$

an assumption we cannot check numerically because of the way in which the data are tabulated.

We find that

$$\bar{X} = \frac{\sum_j n_j X_j}{N} = 32.41,$$

a value whose representativeness we shall assess presently; and

$$\text{Var}(X) = \frac{\sum_j n_j (X_j - \bar{X})^2}{N} = 500.99,$$

whence  $\sigma_X = 22.38$ , a value likewise subject to an external check.

Finally, we require

$$\text{Cov}(Y,X) = \frac{1}{N} \sum_j n_j \bar{Y}_j X_j - \bar{Y}\bar{X} = 90.47.$$

From the foregoing, we obtain immediately the regression coefficient,  $b_{YX} = .1806$ , the intercept  $a_{YX} = 94.75$ , and the correlation  $r_{YX} = .2021$ , so that  $r_{YX}^2 = .041$ . We may also compute the squared correlation ratio,  $\eta_{YX}^2 = .052$ , taking each of the 64 occupation titles as a distinct category.

With this large a sample, the difference,  $\eta_{YX}^2$  minus  $r_{YX}^2 = .011$ , is no doubt too large to attribute to sampling error. The scatter diagram (Figure 6.2.1), however, gives only the slightest suggestion of curvilinearity: most of the variation of occupation-specific means from the regression line is simply scatter of particular occupations at comparable status levels.

In view of the uncertainty about the status score for the occupation, Farmer, and the very substantial number of farmers' children in the Wisconsin data, we are pleased to have observed the near coincidence of the actual mean and the regression estimate. The mean standard score for farmers' children is 96. With an occupational status score of 14, the regression estimate for this group comes out at 97.3.

Our correlation  $r_{YX} = .20$  may be compared with the result stated by Byrns and Henmon (1936, p. 287): "the correlation between mental ability of the student and the rank of the parental occupation, here discovered, for the entire group of students is only +.18." Although we are not quite sure how the latter value was computed, we are reassured by the fact that our manipulations have not resulted in any pronounced distortion of the conclusion originally reached.

In using the foregoing estimates from the data of Byrns and Henmon, one must bear in mind the selectivity involved in their definition of the study population. From the 1930 census we learn that 53.7 per cent of 17-year-old boys in Wisconsin were enrolled in school. Not all of them, however, were high school seniors, the group covered by the testing program. We probably can secure a better estimate of the coverage of the testing program by considering 1940 census data on educational attainment of Wisconsin men 25-29 years old, who were, of course, of high school age around 1930. Of these men, 38.0 per cent are reported as high school graduates and an additional 4.6 per cent as having completed 3 years of high school. In round numbers, therefore, the testing program from which Byrns and Henmon secured their data must have covered about 40 per cent of the Wisconsin boys reaching age 18 in the period 1929-33. The authors give no indication of how far the testing program may have fallen short of covering the target population on account of absences from school and the like.

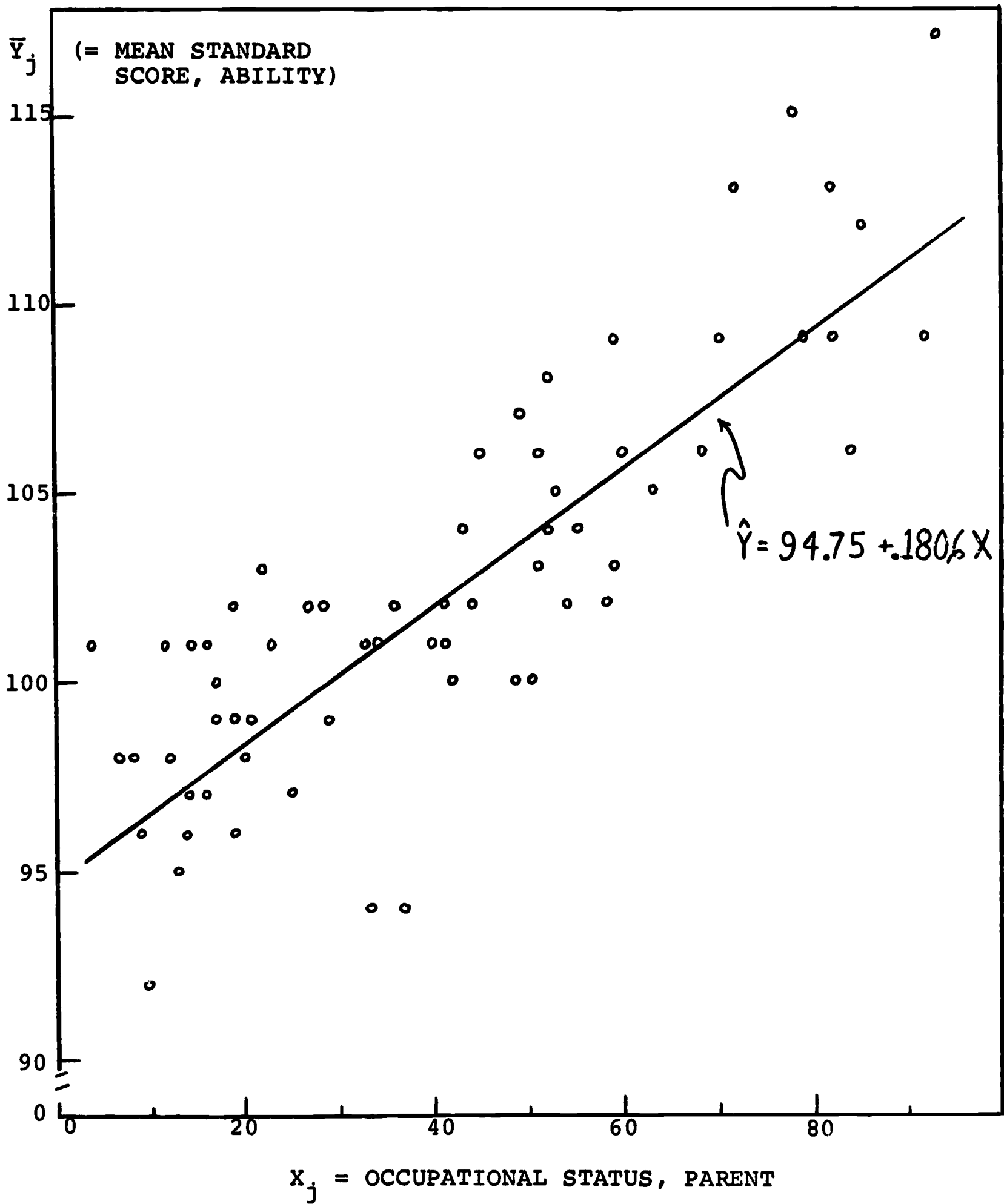

Figure 6.2.1.--Scatter Plot, Mean Standard Scores of Ability on Occupational Status of Parent, Wisconsin High School Seniors, 1929-33 (after Byrns and Henmon).

To evaluate the occupation statistics derived from Byrns and Henmon, we consider national OCG data on native white men 47-51 years old in March 1962 (who were, therefore, 15-19 years old in 1930). For comparability with the population studied by Byrns and Henmon, we exclude those who completed less than 4 years of high school. For this select group of high school graduates we find the mean of father's occupational status is 35.01 (vs. 32.41 derived from the Wisconsin data), with a standard deviation of 23.74 (vs. 22.38). The agreement seems satisfactory, inasmuch as we have no reason to assume strict equivalence of the two populations.

Having considered the correlation of mental ability with one important item of socioeconomic background, we turn to the problem of estimating its correlation with measures of achievement.

A search of the literature suggests that the best historical data for a general population relating IQ measured at an early age to subsequent educational attainment are those compiled by Benson (1942). She followed up 1,989 pupils in the sixth grade of 64 elementary schools of Minneapolis who had been given the Haggerty Intelligence Examination: Delta 2 in April 1923. Records of subsequent achievement (highest grade completed) were obtained for 1,680 cases.

Benson reports, "A product-moment coefficient of correlation of  $.57 \pm .01$  was obtained between IQ and grade level attained" (p. 164). Her Table I is a cross tabulation of IQ (10-point intervals) by 6 levels of attainment. We scored the latter as follows, to conform with our practice in analyzing OCG data:

- 3: "Did not enter high school" (but presumably finished at least 6th grade and, for the most part, 8th grade)
- 4: "Entered high school but did not graduate"
- 5: "Graduated from high school but did not enter college"
- 6: "Entered college but did not receive any degree"
- 7: "Received bachelor's degree"
- 8: "Took graduate work or received advanced degree"

Using these scores and the midpoints of IQ intervals we found a correlation of  $.542$  ( $r^2 = .294$ ). The regression of education on IQ was  $.0321$ , with an intercept of  $0.99$ . Mean IQ was  $112.4$  with a standard deviation of  $19.38$ . (We have ignored the "Stanford-Binet equivalents" also given by Benson; these have a somewhat smaller standard deviation.)

As a rough check on the plausibility of Benson's follow-up data, we looked at 1940 Census data on educational attainment of persons 25-34 years old in Minneapolis. The comparison with Benson's distribution in Table 6.2.1 is moderately reassuring. She, of course, missed the one per cent of children failing to reach 6th grade. The 309 cases not



located in the follow-up were known to be negatively selected on IQ. A median of 108 is reported for the 1,989 cases originally tested as against 112 for the 1,680 cases followed up. We infer that the mean IQ of the 309 lost cases was around 86. Disproportionate numbers of them probably were early dropouts. This may help to account for the underrepresentation of persons failing to enter high school in Benson's sample, but leaves us puzzled at the overrepresentation of those completing 1-3 years of high school. An alternative explanation, of course, is response error in the census data or lack of comparability between the two sources. In illustration of the latter, it seems likely that many of Benson's respondents who "entered high school but did not graduate" actually dropped out before finishing the ninth grade. In that event, the census type of question would classify them as Elementary, 8 years, rather than High School, 1 to 3 years.

Altogether, one can feel considerable confidence when taking a value of .5 or .6 as the correlation between IQ and educational attainment in cohorts completing their schooling during the 1930's. Interestingly enough, this seems to be about the value obtained in correlating IQ scores obtained on adults with their past history of schooling--a point we can check more carefully with the CPS-NORC data and other sources.

Table 6.2.1.--Per Cent Distribution by Educational Attainment, for Persons 25-34 Years Old Living in Minneapolis in 1940 and for Sample Studied by Benson

Years of School Completed	1940 Census	Benson
<b>Elementary</b>		
None to 5	1	...
6 to 8	20	16
<b>High School</b>		
1 to 3	23	35
4	36	31
<b>College</b>		
1 to 3	11	10
4	6	6
5 or more	3	2
<b>Total*</b>	<b>100</b>	<b>100</b>

\*Excludes attainment not reported.

Source: 1940 Census of Population, Vol. IV, Part 3; Benson (1942, Table I).

We present next some calculations on data summarized by Harrell and Harrell (1945), whose paper shows summary statistics of the AGCT (Army General Classification Test) scores of 18,782 white enlisted men in the Army Air Forces Air Service Command during World War II. The statistics are classified into 74 previous civilian occupations of these men. The Harrell report contains no information on age, educational attainment, geographic origin or other social characteristics of the sample. Apparently, occupations infrequently represented in this population were simply omitted from the tabulations.

To match census occupation titles (approximately), it was necessary to combine certain of the Harrell categories. Hence, the present analysis concerns 69 occupation groups.

The AGCT was designed to have a mean of 100 and standard deviation of 20. The Harrell sample as a whole yields a mean of 106.6 with standard deviation 19.1. Evidently, selection into the Air Forces enlisted man population involved some screening for intelligence.

When the 69 occupations are scored on Duncan's (1961a) status scale we obtain a mean of 31.8 and standard deviation of 19.2. These figures suggest that the sample is not highly unrepresentative of civilian occupations of young men. Duncan and Hodge (1963), for example, report a mean of 35.5 with standard deviation 22.1 as of 1940 for a Chicago sample of white men 25-34 years old in that year. The Harrell sample may, therefore, underrepresent men at the extremes of the occupational status distribution.

In Table 1 of the Harrell paper we have the mean and standard deviation of the AGCT scores of men in each occupation. It is, therefore, easy to compute the within-occupation and between-occupation sums of squares; the total sum of squares follows at once. We find  $\eta^2$  of AGCT on occupation is .2288. The correlation coefficient of AGCT with occupational status is .4241; hence  $r^2$  is .18. The regression coefficients are .4264 for occupational status on AGCT and .4218 for AGCT on occupational status. In causal models we would probably wish to think of occupational status as a function of intelligence. Hence the former regression is perhaps the more relevant one. The Harrell table, however, shows mean AGCT for given occupation. It is only the latter regression, therefore, that we can inspect for evidence of curvilinearity. The scatter diagram (Figure 6.2.2) shows little evidence of systematic departure from a linear relationship.

A second set of Army data for white enlisted men is available in a report by Stewart (1947). A similar collection of data for civilian samples tested with the GATB (General Aptitude Test Battery) will also be studied here (U.S. Bureau of Employment Security, 1962).

Stewart's data pertain to 81,553 white enlisted men in 227 different occupations. Occupations infrequently represented in her original sample were omitted from the published report. The occupational

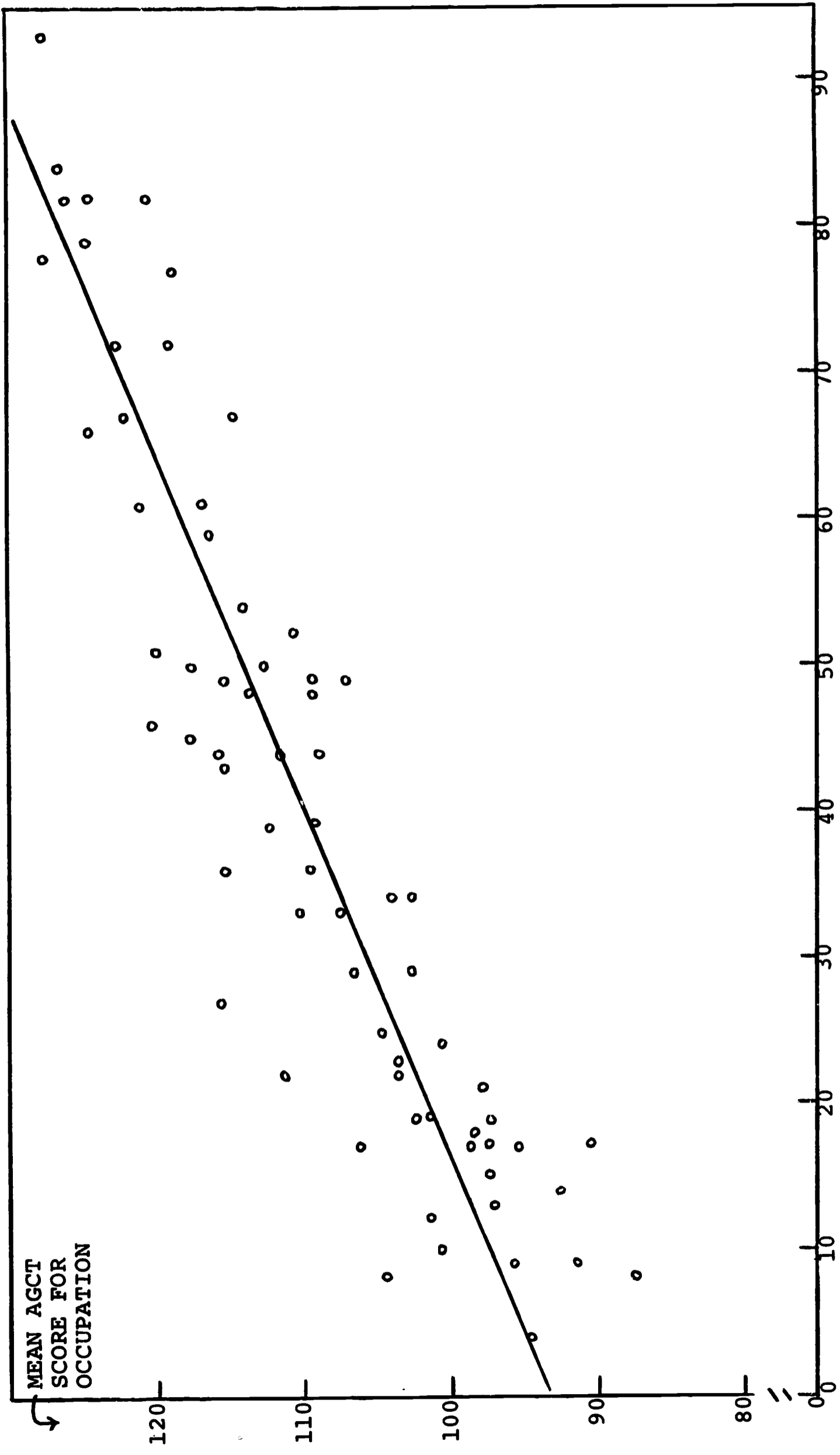

Figure 6.2.2.--Regression of AGCT Score on Previous Civilian Occupational Status.

categories for Stewart's data are, therefore, considerably more detailed than those used in Harrell and Harrell's data described above.

Some occupations on Stewart's list were discarded: specifically, all titles with a "student" prefix, such as "Student, Medicine," and a few which could not be given a census code. Stewart reports values of percentiles 10, 25, 50, 75, and 90 for each occupation. We used only the median (P<sub>50</sub>) values, and treated them as occupation-specific mean scores. Since Stewart does not report a standard deviation for her whole sample, we took it to be 20, and used this figure in calculating the variance and sum of squares of AGCT scores. The mean AGCT score for the 62,233 cases included in our calculations is 101.6. The statistics on occupational status in this sample are mean 25.9 and standard deviation 18.6. Thus Stewart's sample has rather lower means on both AGCT and civilian occupational status, but the standard deviation of the latter is quite comparable with the value observed in the Harrell and Harrell material.

The following tabulation compares the regression statistics obtained from the two sources:

	<u>Stewart</u>	<u>Harrell</u>
Correlation, AGCT and occupational status	.446	.424
Regression, AGCT on occupational status	.481	.422
Regression, occupational status on AGCT	.414	.426
Eta <sup>2</sup> , AGCT on occupation	.253	.229

In view of the differences in population coverage and the detail of the occupational classification, the similarity between the two sets of results is remarkable. It is difficult to foresee any use for these results where the differences will be of material consequence.

Turning to the civilian data, we consider GATB scores on Aptitude G (Intelligence) collected by the U.S. Employment Service. Like the AGCT, this score is designed to have mean 100 and standard deviation 20 in the general population. The sample providing data for specific occupations, however, is not a cross-section sample but a collection of samples of specific occupations obtained in what appears to have been an ad hoc and expedient fashion. While the occupation titles are extremely specific, they do not cover the total occupation structure to the degree that the military data do.

The source publication gives sample size, mean, and standard deviation for each of the specific occupations. We deleted a considerable number of occupations the samples for which were predominantly female. The mean for all of the 17,173 cases covered in the source was 100.36; for the 7,858 deleted cases it was 90.68; for the 9,315 cases studied here it was 108.53. (These figures, of course, are not relevant to the question of general sex differences in intelligence.) Despite

the upward bias of this sample's mean, the standard deviation remained 19.99, or effectively 20.

There is likewise an upward bias in the distribution of status scores for the occupations included. The mean for the group studied here is 43.85, with a standard deviation of 21.86.

If the sample for each specific occupation were representative, there would be no bias in the regression coefficient of intelligence (G score) on occupational status. This regression is .504, which may be compared with the regression of AGCT on occupational status of .481 from the Stewart data and .422 from the Harrell data.

The GATB analysis provides a correlation coefficient of .551 between intelligence and occupational status, which is somewhat higher than those obtained from the two AGCT series, .446 and .424 respectively. In view of the (probable) nonrepresentativeness of the occupations covered in the GATB data, one would not accept this as an estimate for the general population.

An interesting feature of the GATB data is the high value of  $\eta^2$ , for the correlation ratio of G-scores on occupation. A value of .490 is obtained, in contrast to .253 and .229 for the two AGCT studies. Yet we have seen that the linear regression of intelligence on occupational status score is not markedly higher in the GATB data than in at least one of the AGCT sets. Evidently, the detailed occupational coding and/or the sampling technique of the GATB study produced a good deal of inter-occupation variation in intelligence not captured in the military data. But this additional variation is not particularly related to occupational status.

In consequence, the GATB occupation-specific means show a good deal more scatter around the regression of intelligence on occupation than do the AGCT means, even though the regression itself is much the same (see Figure 6.2.3).

To summarize: Two sets of military and one set of civilian data give essentially consistent indications of the degree of relationship between tested intelligence and occupational achievement. If anything, the civilian data suggest a slightly stronger relationship. The difference, if not due to technicalities solely, could be due to the fact that the military data refer to former civilian occupations of very young men, many of whom had doubtlessly not yet established their occupational career lines at the time of induction.

### 6.3. Preliminary Models

The information in hand, to this point in the discussion, is summarized in Table 6.3.1. We wish now to indicate how these data may be used in securing an extension of the basic model of the process of

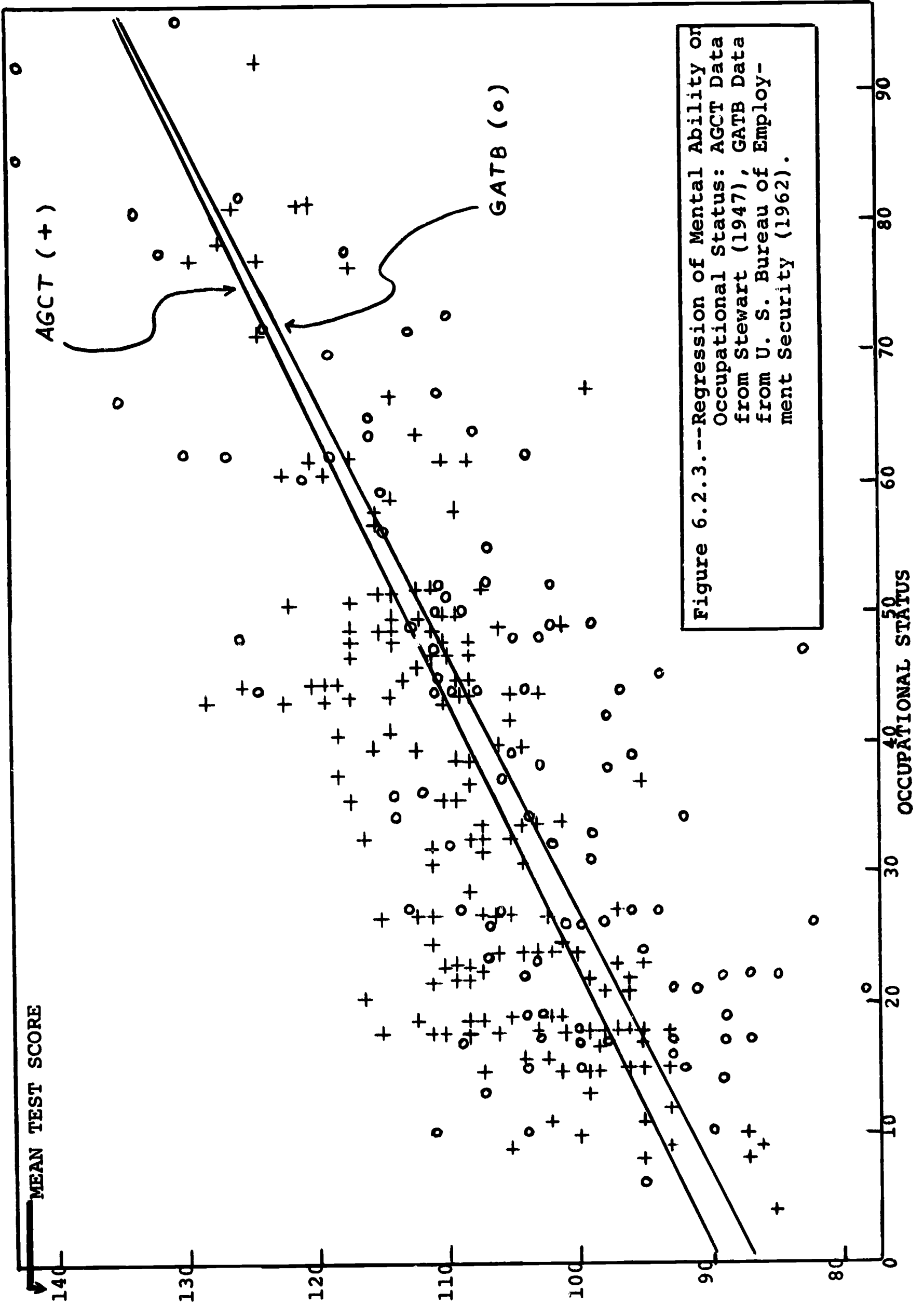

occupational achievement. Figure 6.3.1 recapitulates one set of estimates on this model from Blau and Duncan (1967, p. 174). For the moment, we are taking as the terminal occupational status the "first job" reported in the OCG data, assuming it is the nearest possible approximation to the data on previous civilian occupation given in the studies of military mental ability tests. The status of "first job" is represented

Table 6.3.1.--Correlations Used in Estimating Path Coefficients in Model 6.3.2.

[Key to sources below diagonal]

Variable	(Q) IQ	(X) Fa's occ.	(V) Fa's ed.	(U) R's ed.	(W) 1st job
(Q) Respondent's intelligence	...	.20	.25	.54	.43
(X) Father's occupational status	(1)	...	.52	.44	.42
(V) Father's education	(2)	(5)	...	.45	.33
(U) Respondent's education	(3)	(5)	(5)	...	.54
(W) Status of first job	(4)	(5)	(5)	(5)	...

Sources:

- (1) Byrns and Henmon (1936).
- (2) Unpublished data of W. H. Sewell (WISC data set).
- (3) Benson (1942).
- (4) Average of two sets of AGCT data (Harrell and Harrell, 1945; Stewart, 1947).
- (5) OCG study, all men 20-64 years old.

as being dependent upon educational attainment and status level of father's occupation. Educational attainment, in turn, is taken to depend upon the father's occupational status and his educational attainment--although one might well have used alternative measures of socioeconomic background. Both occupational statuses--the father's (as of respondent's age 16) and the respondent's first job--are scaled on Duncan's socioeconomic status index for detailed occupations. Educational attainment is the number of years of regular schooling completed.

The models are linear causal systems which are hypothesized to account for the observed associations among measured variables. The path coefficients shown for Model 6.3.1 were estimated from data for men 20 to 64 years of age. Slightly different results are obtained in making the estimates for different populations, such as men with nonfarm background, white men, or men in a more restricted age range. Such differences are not at issue here, however, as we have introduced Model 6.3.1 only for illustrative purposes.

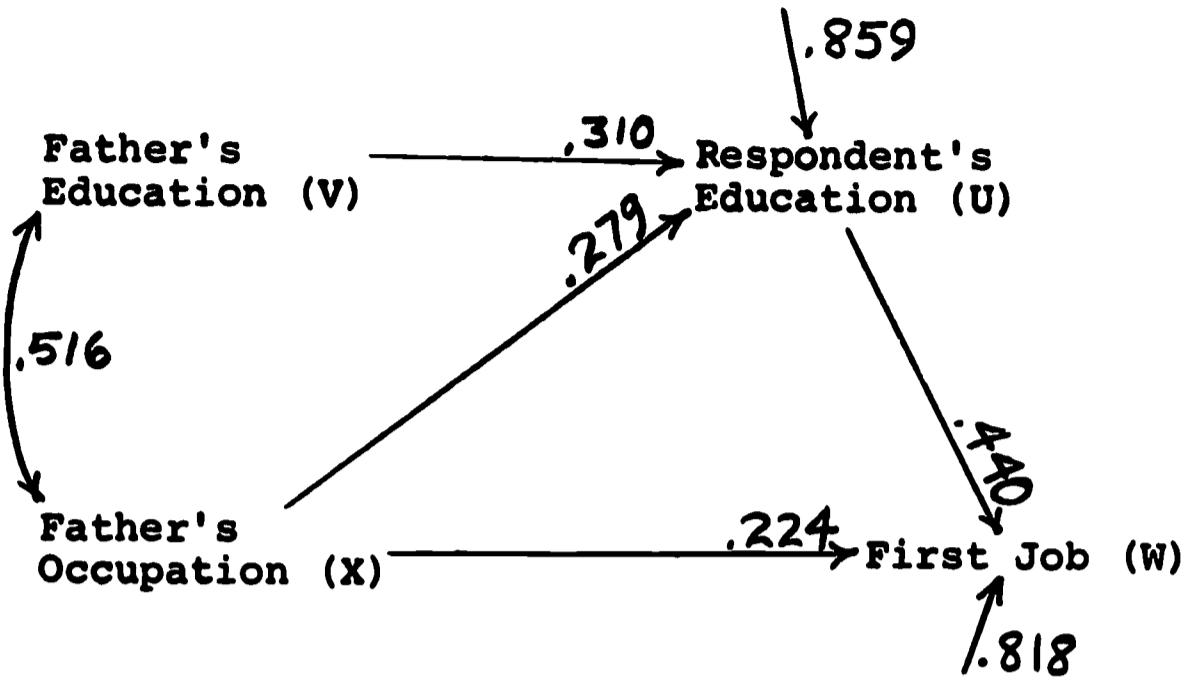

Figure 6.3.1.--Basic Model, with Estimates Based on OCG Data for All Men, 20-64 Years Old.

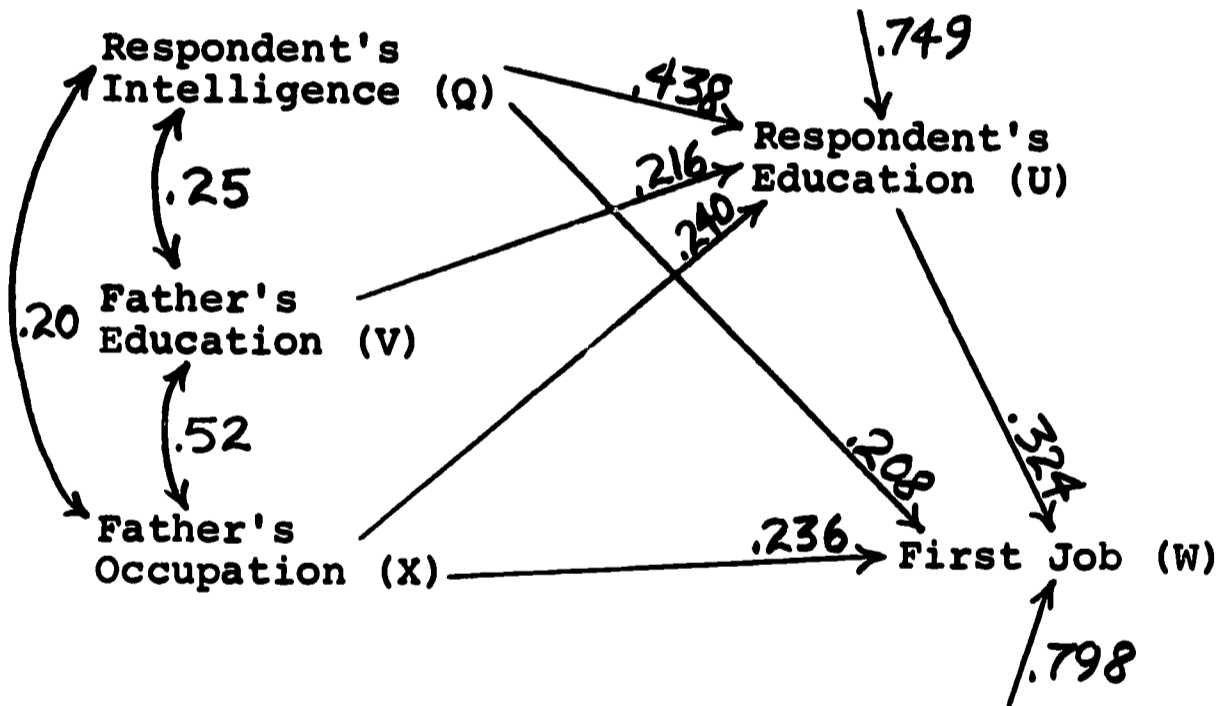

Figure 6.3.2.--Extended Model, Based on Data in Table 6.3.1.



The extension we wish to entertain involves considering measured intelligence as a background factor, along with the socioeconomic measures. Thus Model 6.3.2 represents the status of the first job as depending directly upon educational attainment, both directly and indirectly upon father's occupation and respondent's intelligence, and only indirectly upon father's education. Respondent's education, in turn, depends upon intelligence and the two socioeconomic background items. It should be noted that the model requires no assumption concerning the nature of the linkage between socioeconomic background factors and intelligence. Such a correlation could arise on the basis of either genetic or social mechanisms or, more likely, a combination of both. For the purposes of the present model, it suffices to recognize that the correlation exists. A quite different model would be required to represent hypotheses about how the correlation is produced.

The data used in estimating path coefficients for Model 6.3.2 are shown in Table 6.3.1. At this juncture we are venturing to combine into one model estimates of correlations obtained for several different populations. This tactic will also be followed in our subsequent work. Ideally, we should resort to this procedure only if we had equally representative and reliable samples of the very same population. This condition will seldom be met, and we shall have to assume comparability of data from different sources when there is every reason to believe such comparability does not strictly hold. From this standpoint, all results obtained on this procedure had best be regarded as hypotheses for ultimate verification upon a single population for which all relevant measures can be obtained. Even though our procedure is hazardous, it is not actually different from the informal practice of investigators who draw conclusions by comparing information developed in two or more studies. Or, rather, the difference is that we are here undertaking formally what is common in informal practice. Presumably any liability of the procedure should be more apparent when it is controlled by the formalism of an explicit model than it would be in the absence of such a control.

The importance of taking intelligence explicitly into account is suggested by a comparison of Model 6.3.1 with Model 6.3.2. As far as occupational achievement is concerned, inclusion of intelligence as a background factor does not markedly increase the proportion of "explained" variance in status level of the first job. The residual factor for W (first job status) is .818 in Model 6.3.1 as compared with .798 in Model 6.3.2. Translating these into proportions of variance not accounted for (the square of the residual path), we have 67 per cent of the variance of W not accounted for in Model 6.3.1, as against 64 per cent in Model 6.3.2. This result dashes any hope that availability of intelligence test scores will enable the investigator to improve markedly the prediction of early occupational achievement as compared with what he can do with education and socioeconomic background factors alone.

On the other hand, Model 6.3.2 gives us a rather different interpretation of the nature of the process of status achievement from that implied by Model 6.3.1. A substantial direct path from intelligence to

first job must be entered into the system. When this is done, the apparent direct effect of education is diminished, for in Model 6.3.2 education is represented as affecting first job only insofar as it operates independently of intelligence, as well as socioeconomic background. Phrased otherwise, the apparent effect of education in Model 6.3.1 includes some variation in first job status that is actually due to intelligence, given that intelligence affects educational attainment.

This result assumes a certain importance in view of the current interest in estimating "returns from education" in an economic sense. Conventional census data reveal that amount of income earned rises with increments to years of schooling. Economists studying the rate of return to education have noted, however, that number of years of schooling partly reflects differences in ability. It has been observed, moreover, that the effect of education on income is transmitted, in considerable measure, via occupational level. At this point we cannot yet include income as a further output of Model 6.3.2, although a model with this feature is presented subsequently. However, we are in a position to look at the respective roles of education and intelligence as determinants of occupational status.

If we look at the gross association of education with occupational status, as measured by the simple (zero-order) correlation between the two, we find the substantial value of .54 (see Table 6.3.1). Model 6.3.1 suggests, however, that education is operating in part to transmit the effect of socioeconomic background, so that its direct effect in a model incorporating such background items is reduced to .44. Even this figure is seen to be an overestimate, in the light of Model 6.3.2, where with both socioeconomic background and intelligence included in the system, the direct effect of education shrinks to .32. In this model, education is estimated, then, to have a direct effect of .32 and an indirect effect, due to its correlation with antecedent determinants of first job, of .22 (the original simple correlation, .54, less the direct effect, .32). To be sure, the remaining direct effect is still substantial, and its significance is enhanced by the fact that it is measuring the impact of education on occupational achievement independently of some of the obvious determinants of both education and occupation level.

The reduction in the apparent role of education as between Models 6.3.1 and 6.3.2 contrasts with the lack of change in the direct effect of father's occupation in the two models. Since the correlation between father's occupation and respondent's intelligence is only .2 (according to the estimate used here), inclusion of intelligence in the model hardly affects the estimate of the direct effect of father's occupation; we find it to be .22 in Model 6.3.1 and actually a little higher at .24 in Model 6.3.2. Again, it should be remembered that this is an estimate of the net impact of father's occupation on respondent's first job, taking into account its correlation with respondent's intelligence and the fact that it works partly via its influence on education--i.e., net of these indirect paths of influence. The net or direct effect of

father's occupation is, of course, less than its gross association with first job, which comes to .42 (see Table 6.3.1).

It will have been noted that no direct effect of father's education on first job is shown in the model. This is the case because such direct effect is very nearly zero and not statistically significant. A version of Model 6.3.1 which included a direct path from V to W yielded a coefficient of .014, rather less than the standard error of the coefficient (Blau and Duncan, 1967, p. 174).

The inclusion of intelligence in the model not only puts a new-- and presumably more realistic--interpretation on the roles of education and socioeconomic background factors in occupational achievement; it also leads to a more adequate accounting for the variation in education. In Model 6.3.1, where only socioeconomic background was considered, the residual factor for U is .859, implying that 74 per cent of the variance in educational attainment is unexplained. In Model 6.3.2, with the residual path of .749, this figure is reduced to 56 per cent. The model, even so, is far from exhausting the variance in education.

For advocates of equal opportunity, it may be reassuring that intelligence is clearly more important than socioeconomic background as a determinant of educational attainment. Its direct effect is .438, its indirect effect, due to correlation with socioeconomic background, .102 (the sum of these, .54, being the simple correlation between education and intelligence). On the other hand, it is clear that socioeconomic background influences how far boys go in school, quite apart from differences in measured ability. This is apparent from the path coefficients for V and X, father's education and occupation.

To analyze the matter in a slightly different way, we can note that, by itself and including its role in mediating effects of socioeconomic background, intelligence accounts for 29 per cent of the variance in schooling (the square of .54, the zero-order correlation between the two variables). In combination, intelligence and the socioeconomic background items account for 44 per cent of the variance in education. The increment of 15 percentage points (44 - 29) is the net contribution of socioeconomic background, as measured by the two characteristics of the father, quite apart from any indirect effects of socioeconomic origins operating via intelligence. Whether this net influence amounts to an inequality of "opportunity" or represents inequality in some kinds of social, economic, or psychological resources which a family may bestow upon the child remains to be estimated. Experience with models of this kind suggests that inclusion of explicit measures of economic resources, such as family income, would not alter greatly the estimate of the combined impact of all socioeconomic factors on educational attainment. What other kinds of "resources" should be postulated is a separate question. In subsequent discussion, we bring one other suggestive item of information to bear upon this difficult question.

The next complication of the basic model to be considered arises from the introduction into it of a variable reflecting family structure, to wit, number of siblings. For the remainder of this discussion of preliminary models, we shall omit consideration of occupational status, so that the model presented next has only one output variable, educational attainment. Model 6.3.3 is taken from the work of B. Duncan (1965). Her work was based on data for a subgroup of the OCG sample, consisting of native white males 27 to 61 years old in 1962. The model happens to include a variable, labelled "intact family," which we shall subsequently ignore; but its inclusion probably has little effect on the path coefficients for the other determinants of educational attainment, since its correlations with them are so low. The intercorrelations among the background variables are shown on the diagram. Their respective correlations with the dependent variable are as follows:  $r_{YF} = .087$ ;  $r_{YT} = -.344$ ;  $r_{YU} = .414$ ;  $r_{YX} = .434$ . When the population is limited to native white males, father's education diminishes in relative importance (as compared to father's occupation) as a factor in educational attainment of respondents. This is apparent both in the simple correlations and in the path coefficients for Model 6.3.3. An appreciable negative path for number of siblings is estimated, and this factor is itself negatively correlated with the other background factors.

The new interpretation of these data which is required when intelligence is taken into account appears as Model 6.3.4. The crucial item of information is the correlation of intelligence with number of siblings. This correlation is not available in any of the sources from which we have obtained other correlations for intelligence. However, the correlation of IQ with number of siblings has been studied rather extensively (Anastasi, 1956), and there is a sizeable and controversial literature on the interpretation of this relationship. The most representative figure for the observed correlation between number of siblings and standard intelligence tests in unselected populations seems to be about  $-.3$ ; and this value has been selected for the purpose of our illustrative calculations. In Model 6.3.4 we are unable to include the "intact family" variable, but as already indicated it seems unlikely that its insertion into the model would alter the other paths appreciably.

Close comparisons between Model 6.3.3 and 6.3.2 are not warranted, since the latter pertains to a somewhat different population from the former. However, there is general resemblance between the two except, of course, for the additional path to education in Model 6.3.3 and the omission from it of the first job. With intelligence and socioeconomic background held constant, number of siblings retains a significant direct effect on schooling. It is interesting, however, to see the extent to which the sibling variable operates via other variables in the system. Its zero-order correlation with educational attainment, noted above, is  $-.344$ ; with socioeconomic background items held constant, the direct effect shrinks to  $-.203$  (in Model 6.3.3); and with intelligence as well included among the background factors there is a further shrinkage to  $-.099$ . A full interpretation of this outcome would require

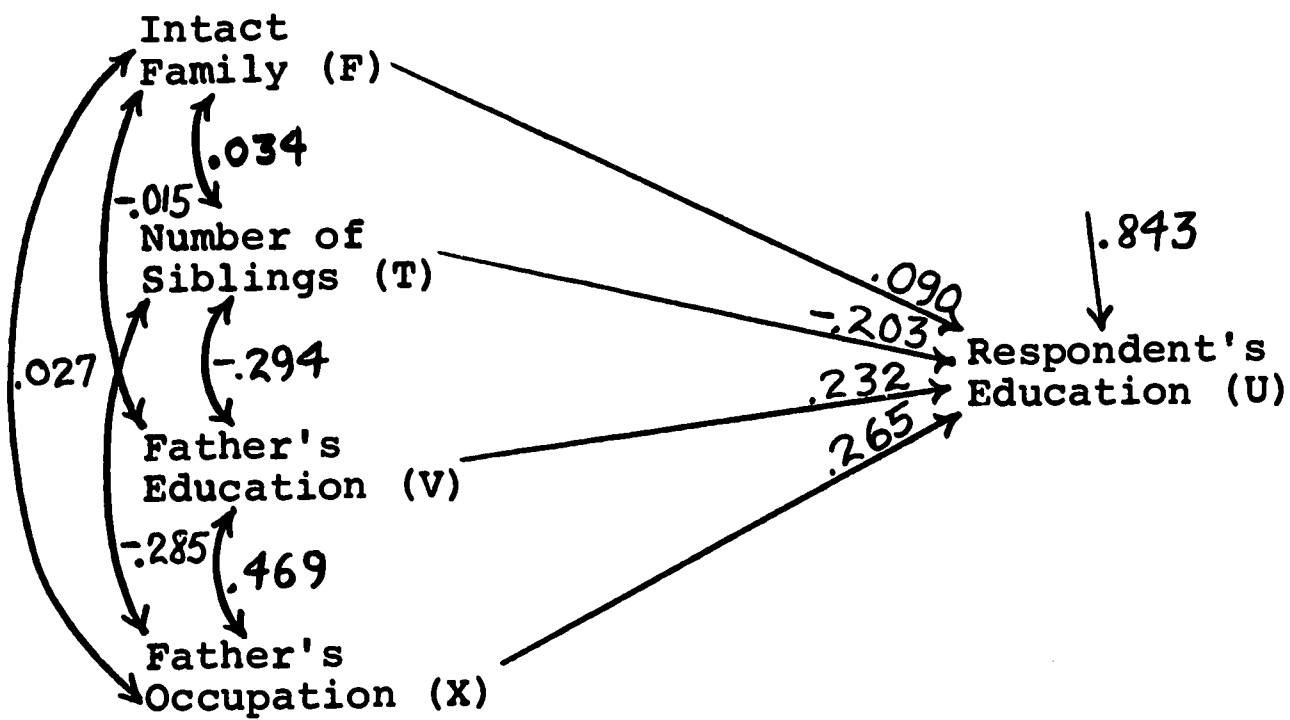

Figure 6.3.3.--Basic Model of Educational Attainment, with Estimates for Native White Men 27-61 Years Old (B. Duncan, 1965, Chapter 3).

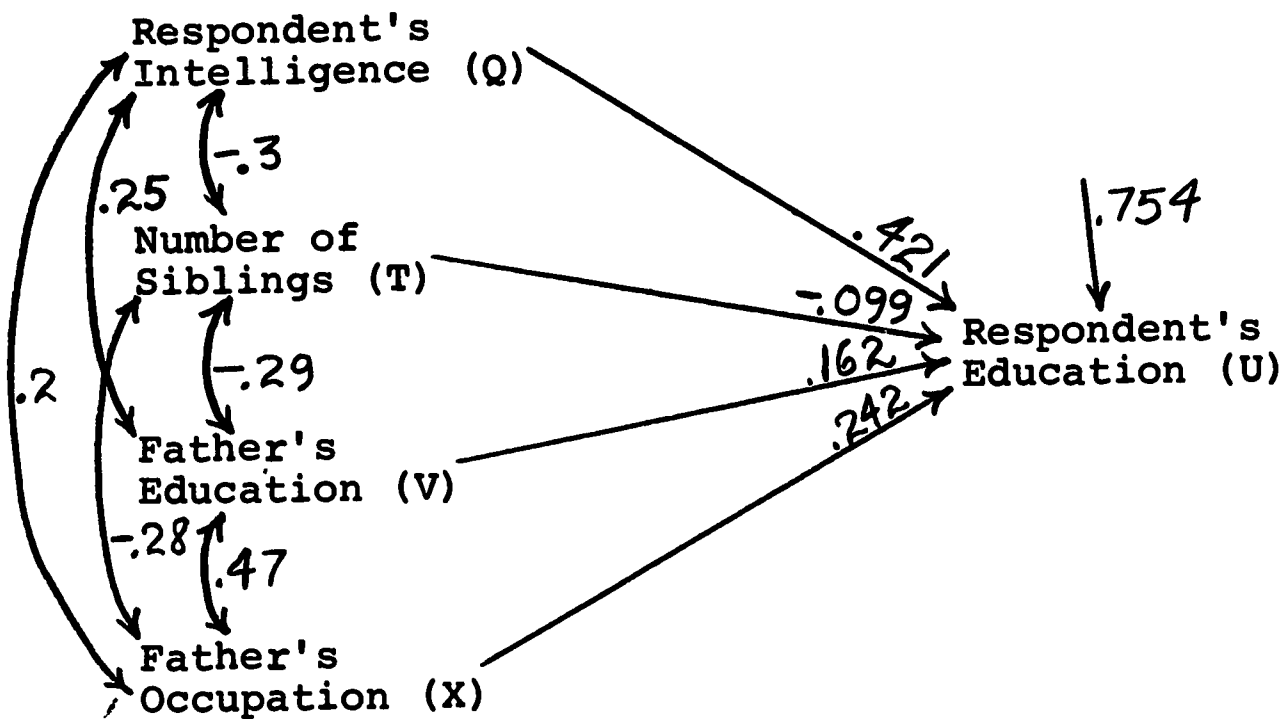

Figure 6.3.4.--Educational Attainment as a Function of Family Background and Intelligence.

a considerable elaboration of Model 6.3.4, to "explain" the inter-correlations of the background variables taken as given in that model. Such an explanation would raise complicated issues of "heredity vs. environment," for there is no agreement on the extent to which the inverse correlation of number of siblings and intelligence represents environmental effects on intellectual development as over against dysgenic fertility patterns (Burt, 1947; Nisbet, 1953).

Since Model 6.3.4 includes both intelligence and socioeconomic background, the path coefficient of approximately  $-.1$  for number of siblings must represent other influences than these. The most obvious observation is that children in large families enjoy lesser economic resources per head than children in small families, given that the families are at the same socioeconomic level. The same may well be true of other resources as well. In a large family, parental aspirations may not be as sharply focused on any one child, designated at random, as in the small family.

An elaboration of Model 6.3.4 on a quite conjectural basis appears in Model 6.3.5. Here we raise the question of how similar the educational outcomes would be for two brothers in the same family. We assume that since the two brothers have the same father and the same number of siblings, values of T, V, and X are the same for them. This is actually a simplification, because, for example, father's occupation is specified as of the date the respondent was 16 years old, and two brothers would not have attained that age in the same year, apart from the case of twins. We assume, moreover, that the socioeconomic background factors act in precisely the same way for the two brothers, so that there is only one set of path coefficients applying either to respondent's education or to brother's education. A further assumption is that intelligence of either brother is intercorrelated with background items in the same way as for the other brother and acts in the same fashion on schooling.

Finally, the crucial assumption concerns the correlation between the intelligence scores of the two brothers. This particular correlation has been studied rather extensively. A recent review article instances no less than 35 inquiries into the correlation between siblings in intelligence (Erlenmeyer-Kimling and Jarvik, 1963). Rather widely varying figures, from less than  $.3$  to nearly  $.8$ , have been obtained. The median of the 35 correlations is, however,  $.49$ . Whether or not this is a mere coincidence, the empirical correlation is very close to the theoretical genetic correlation of  $.5$  between siblings which follows from highly simplified assumptions. Without commenting on the implications of this coincidence, we shall take  $.5$  as the correlation between brothers' intelligence scores.

In Model 6.3.5 it should be noted that educational attainment is not assumed to be directly affected by brother's intelligence, so that there is no path from Q' to U or from Q to U'. Such a direct effect would be theoretically anomalous. As we shall see, however, this

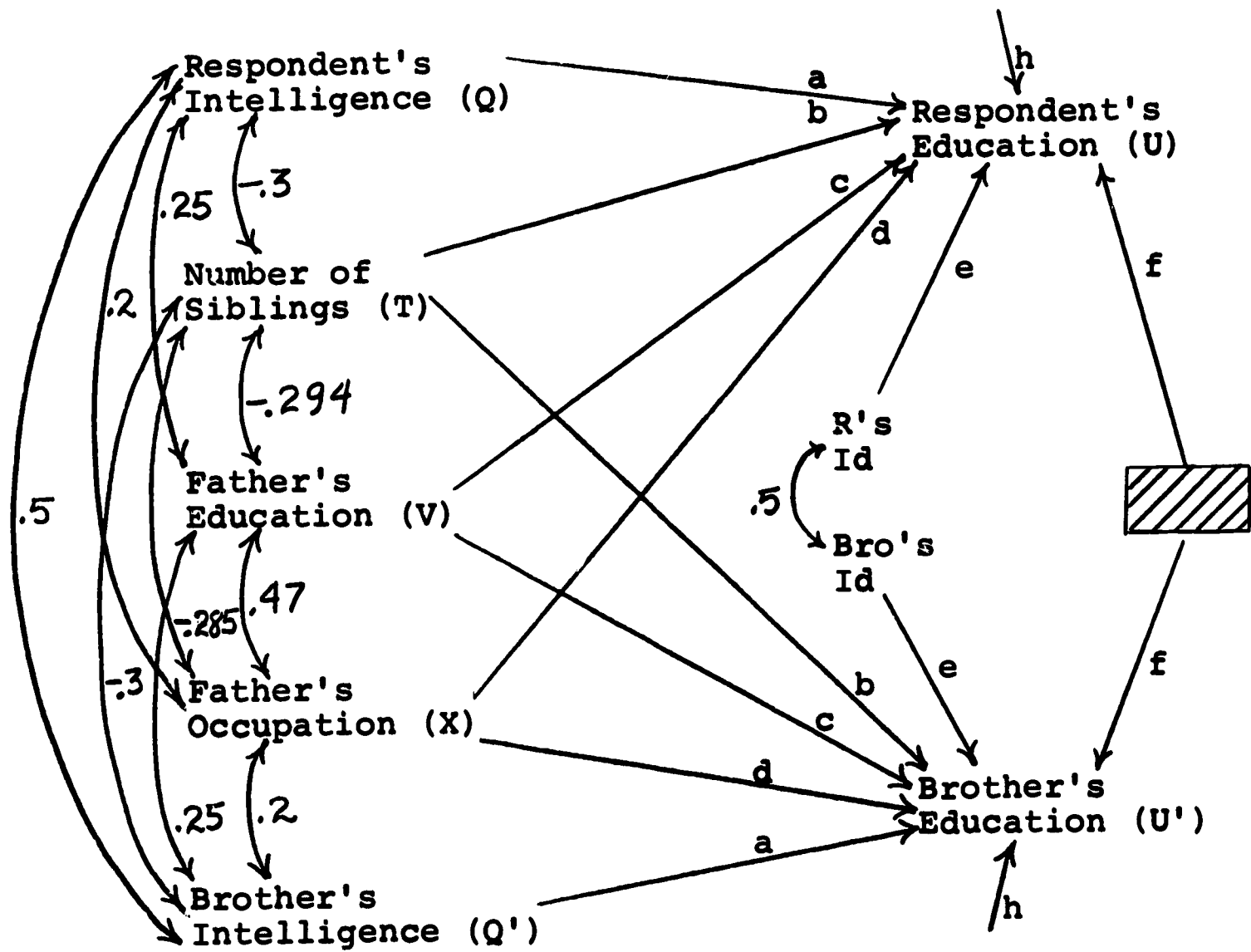

Model 6.3.5(a): Omit paths shown as f.

Model 6.3.5(b): Omit paths shown as e.

Figure 6.3.5.--Correlation between Siblings in Regard to Educational Attainment, Interpreted in the Light of Model 6.3.4.

assumption does not require that the simple correlation between  $Q'$  and  $U$  or  $Q$  and  $U'$  be zero.

When either brother is considered separately, therefore, Model 6.3.5 merely repeats Model 6.3.4, and we shall therefore transfer the respective path coefficients from the latter to the former. Hence for the direct effect of intelligence on schooling (for either brother) we have  $a = .421$ ; for the effect of number of siblings,  $b = -.099$ ; for the effect of father's education,  $c = .162$ ; and for father's occupation,  $d = .242$ . For the moment, let us disregard both the paths labelled  $e$  and  $f$ . Then the residual path,  $h$ , is the same as in Model 6.3.4, or  $.754$ , implying that 57 per cent of the variance in educational attainment is not accounted for by the model (whichever brother is in question).

If Model 6.3.5, omitting paths  $e$  and  $f$ , were literally correct, we could derive the correlation between educational attainments of the two brothers, making use of the appropriate theorem from the theory of path analysis:

$$r_{UU'} = ar_{QU'} + br_{TU'} + cr_{VU'} + dr_{XU'} .$$

This expression includes a correlation ( $r_{QU'}$ ) which is not among our empirically given coefficients. But it, too, is readily obtained from the model, assuming the model to be correct:

$$r_{QU'} = ar_{QQ'} + br_{QX} + cr_{QV} + dr_{QT} .$$

We first compute  $r_{QU'}$  as  $.329$ ; inserting this value into the earlier formula (along with the path coefficients and other designated correlations), we secure the implied value  $r_{UU'} = .341$ .

We are now in possession of a commodity that is all too rare in sociological analysis: a precise quantitative "prediction" from an explicit model. The prediction, of course, does not concern some future event in the real world, but the result of an inquiry that might be undertaken to ascertain whether the implied relationship is correct. In this case, however, we shall not have to wait long to test the prediction. The OCG data include readings on the educational attainments of both the respondents and their oldest brothers (for the roughly half of the sample having an older brother and able to report his number of years of schooling). The correlation between respondent and oldest brother is not exactly what is called for by Model 6.3.5, which treats the two brothers symmetrically. But it is at least worth considering how well the OCG result for brother's education conforms to the outcome deduced from Model 6.3.5. In fact, the OCG data for all native non-Negro men 25 to 64 years of age indicate a correlation of  $.573$  between respondent's education and education of oldest brother, which is considerably higher than  $.341$ , the value implied by the model. Evidently, the model is incorrect, or else the correlation between respondent and oldest brother is materially greater than the correlation between



respondent and a randomly chosen brother (both propositions could hold, of course).

If, for the sake of argument, we take the true value of  $r_{UU'}$  to be .573, we shall have to modify the original model. Such a modification--or, rather, two alternative modifications, among many possible ones--are shown in Figure 6.3.5.

Let us consider first Model 6.3.5(a), a version incorporating additional paths labelled "e" (omitting paths "f"). Here we have postulated two mystery variables respectively denoted "Respondent's Id" and "Brother's Id" ("Id" being merely a label for something that behaves in the way to be described). The variable is assumed to have a direct effect, e, on educational attainment, and to be independent of intelligence, number of siblings, and socioeconomic background. Moreover, the correlation between Respondent's Id and Brother's Id is taken as .5. "Id," therefore, might be a trait determined by a simple genetic mechanism, independently of any genetic determination of intelligence, and unaffected by socioeconomic environment. If the reader cares to think of some unconscious motivational factor arising in such a fashion, he may find some help in the imagery. With this purely illustrative postulate, the model is rendered consistent with our information on the correlation between educational attainments of brothers by inserting an appropriate value for the paths, e. We have already computed the correlation  $r_{UU'}$  produced by paths a, ..., d as .341. Since Id is assumed to be uncorrelated with the other background variables, Model 6.3.5(a) implies that  $r_{UU'} = .341 + .5e^2$ . Taking  $r_{UU'}$  as .573 we can solve for  $e = .681$ . Moreover, the increment to explained variance in U (or U') amounts to  $e^2 = .464$ , so that in Model 6.3.5(a), the residual, h, is reduced to .323, implying that 10 per cent of the variance in educational attainment is unexplained in the model. Evidently, Id is quite a powerful variable, as dynamic psychologists have long suspected!

This "fun with numbers" is not advanced as a serious theory of the determinants of educational attainment. The purpose of the exercise is to illustrate one line of argument, and the consequences thereof. We are trying, in effect, to imagine the response of a behavioral scientist to Model 6.3.4, as he seeks to muffle his disappointment with the large unexplained residual. Many such scientists react initially by speculating about variables left out of the model. Here, we have seized upon the remark that a behavioral scientist might have uttered in a seminar discussing Model 6.3.4, and have followed it to its logical conclusion. We imagine him contending that the model omits "motivation," and observing that high motivation and low motivation are found in both lower and middle class youth for reasons that are difficult to apprehend. To translate such a remark into some definite implication, we have to specify the formal properties of a model embodying the speculative hypothesis being advanced. Other translations than the one just considered could, of course, be entertained; and the consequences would then be somewhat different. What one would like to see in discussions of empirical results, when they take a speculative direction, is an attempt to make the speculations specific enough that their consequences can actually be confronted.

The consequence in Model 6.3.5(a) may (or may not) strike the reader as far-fetched. "Id," whatever it may be, turns out to have a greater net effect on schooling than any of the other determinants with which we are familiar. If this is just a way of stating that the region of our ignorance exceeds the area of our knowledge, no harm is done. If it is, on the other hand, a programmatic dictum, then we know we have a hard job ahead in seeking to measure and identify a powerful factor whose source and nature are at the moment entirely mysterious.

In Model 6.3.5(b), which includes paths labelled  $f$  while omitting those designated  $e$ , we consider a slightly different mystery variable to account for the previously unaccounted for correlation between brothers' educational attainments. The mystery variable is now no longer a trait that might be observed in each brother individually but a characteristic of the family or environment which is common to the two brothers. It is designated as a "grey box," whose content will remain unspecified. Here, in contrast to the previous conjecture, we are assuming that the grey box has exactly the same content for both brothers, whereas in Model 6.3.5(a) the two Id scores were only correlated to the extent of .5. Again, the model permits easy calculation of the unknown path, for  $r_{UU'} = .573 = .341 + f^2$ , yielding the value of .482 for  $f$ . In turn, the residual paths,  $h$ , take on the value .580, implying that 34 per cent of the variance of educational attainment for each brother is unexplained.

Model 6.3.5(b), like its alternate, is a highly specialized modification of Model 6.3.4. The grey box is assumed to be utterly uncorrelated with either intelligence or socioeconomic background. This property immediately rules out such candidates for its content as income, "cultural level" of the home, or even such practices as age at weaning and toilet training (which are thought to vary by social class). To be sure, if the critic can suggest a variable like one of these, and if he is willing to specify not only how it affects schooling but also in what degree it is related to background items, we can entertain still another version of Model 6.3.5 to represent this hypothesis. He will, in any event, have to think of a variable with quite a sizeable influence on schooling, for  $f$  is the largest path in the diagram; and, if the grey box variable were allowed to be positively correlated with background factors, its correlation with schooling would have to exceed  $f$ .

#### 6.4. Ability and Achievement: Final Model

The final model developed in the project is represented in the upper diagram of Figure 6.4.1 and reduced forms thereof are shown in the lower diagram of Figure 6.4.1 and in Figure 6.4.2. The estimates of path coefficients pertain as nearly as possible to the population of U.S. white men 25-34 years old in 1964. About half the correlations among the eight variable in the model are taken from the CPS-NORC data set. The remainder are either taken from other published sources, such

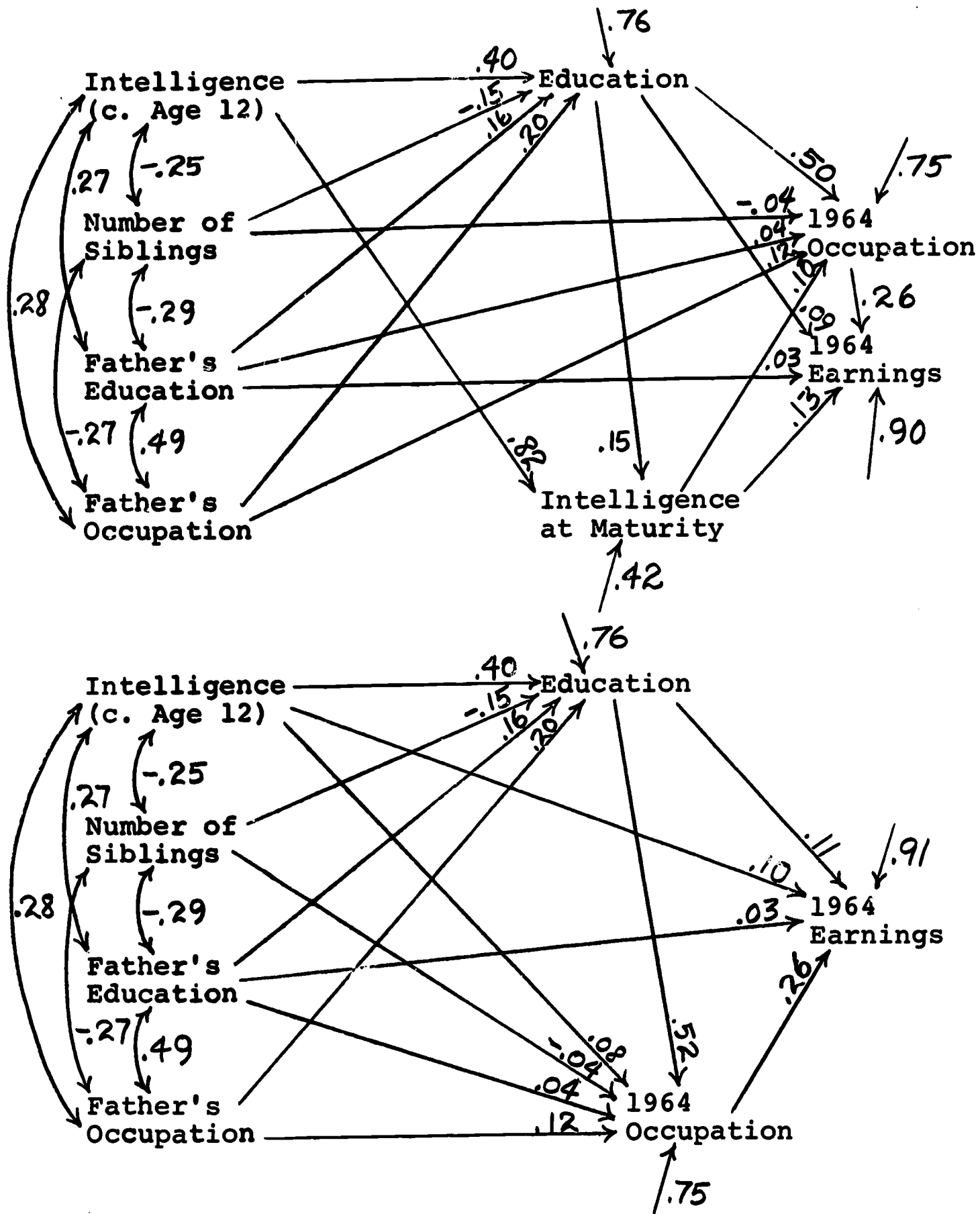

Figure 6.4.1.--Final Model of Ability and Achievement (Upper Diagram) and Reduced Form Omitting Intelligence at Maturity (Lower Diagram). (Source: Report #3.)

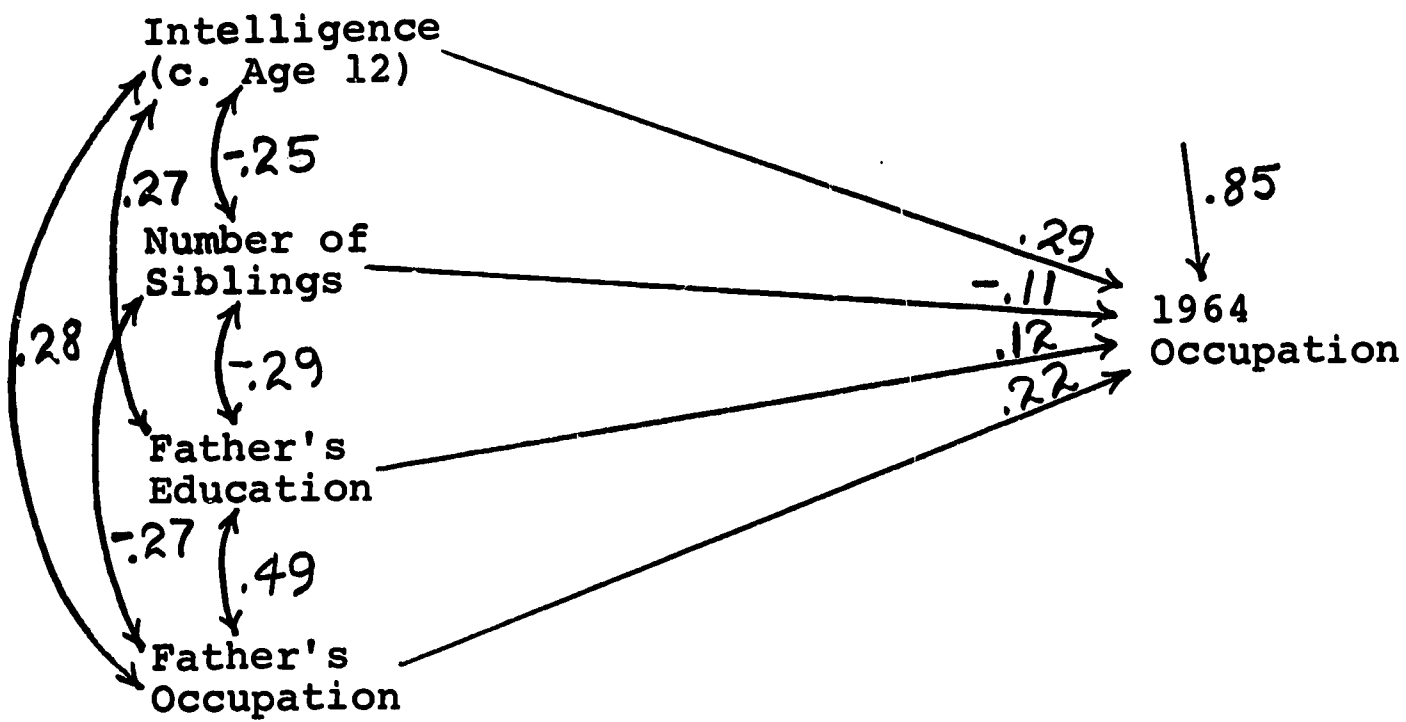
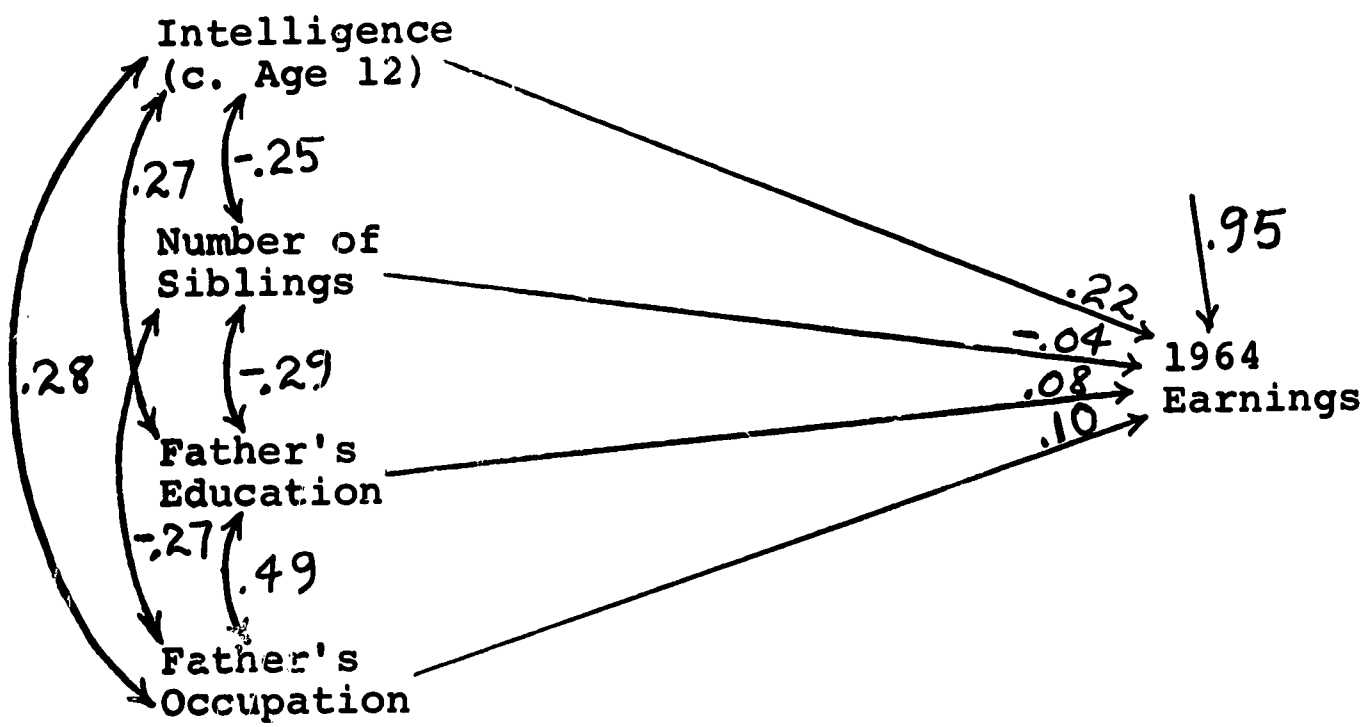

Figure 6.4.2.--Reduced Forms of Final Model of Ability and Achievement.

as those discussed earlier, or are derived from the model itself. The details of the estimates, together with some evaluation of them, are given in full in Report #3.

One important feature of the model is the incorporation of two measures of "intelligence": ability as measured at about age 12, and as measured at maturity. The important work of Bloom (1964) on stability of intellectual traits over the life cycle was consulted in selecting an estimate of .9 as the coefficient of intertemporal stability for intelligence for this segment of the life cycle. The reason why this feature is important is that prior research has left ambiguous the question of the degree to which intelligence measures are contaminated by educational attainment. Thus, in commenting on a Swedish study which showed that IQ is positively associated with occupational mobility, Lipset and Bendix (1959, pp. 234-235) remarked:

Instructive as these data are, they are vitiated in part by the high correlation between I.Q. and educational achievement (.82) and between educational achievement and mobility. Since the intelligence tests were made after the completion of education--in the course of the process of registering for the military draft--and since we know that education itself may result in some improvement of a person's I.Q., the problem of causal imputation is not resolved. Nevertheless, I.Q. tests do measure (even if they do not isolate) native ability, and to this extent [the Swedish] data give clear-cut evidence for the considerable effect of intelligence on social mobility.

In constructing the final model, we explicitly took account of the possibility "that education itself may result in some improvement of a person's I.Q." The estimate of the magnitude of this effect is a function of (1) the correlation between education and mental ability of mature men; (2) the correlation between mental ability of sixth-grade children and subsequent educational attainment, estimated, as previously described, from the data of Benson (1942); and (3) the assumption as to the stability of mental ability over time, as estimated by Bloom.

Once the model is constructed, we may consider that the data on intelligence at maturity have served their purpose in allowing us to estimate all the coefficients. We may then proceed to eliminate that variable from the model, deriving the reduced form shown in the lower diagram of Figure 6.4.1. If the original model is correct, we can be sure that the reduced form does not suffer from the ambiguity to which Lipset and Bendix called attention; the variables can be temporally ordered with fairly little error.

Perhaps the most interesting substantive result is that the bulk of the influence of intelligence on occupation is indirect, via education. The direct path from intelligence to occupation (lower diagram, Figure 6.4.1) is only .08, whereas the indirect path via education is  $(.40)(.52) = .21$ , or more than twice as large. The sum of the two,

$.08 + .21 = .29$  is shown in the lower diagram of Figure 6.4.2 as the entire effect of intelligence on occupation, apart from joint effects with the other three background variables.

The situation is somewhat different in regard to intelligence as a cause of differential earnings. In Figure 6.4.1, it is clear that the effect of intelligence on earnings, net of the effects of education and occupation, is appreciable. Thus, men with the same schooling and in the same line of work are differentially rewarded in terms of mental ability. In the lower diagram of Figure 6.4.1, the direct effect of intelligence on earnings, at  $.10$ , is almost as large as the sum of indirect effects via education and occupation, which comes to  $(.40)(.11) + (.40)(.52)(.26) + (.08)(.26) = .12$ . The combination of direct plus indirect influence,  $.10 + .12 = .22$ , is shown in the upper diagram of Figure 6.4.2 as the entire effect of intelligence on earnings, net of the other three background factors.

### 6.5. Ability and Achievement: A Replication

As was indicated in the previous section, estimates of coefficients in the "final" model of ability and achievement were derived from data for the population of U.S. white men aged 25-34 in 1964; but a considerable part of the information used in making the estimates pertains to other populations. Access to the DAS data set permits a completely independent replication, although one that does not contain quite enough information to estimate the complete model and one for which the issue of temporal stability of measured intelligence is left unresolved. Figure 6.5.1 presents a comparison between estimates secured from the same data used in the previous section and those secured from the DAS data. In the DAS data, the measure of "intelligence" is the "Similarities" subscale of the Wechsler Adult Intelligence Scale. As we have used this scale here, it is interpreted to refer to intelligence as it would have been manifested at some point well before the termination of schooling. That this is a distortion of the probable facts is the main message of the manipulations involved in the work reported in section 6.4. Yet the results of that work also suggest that the distortion is comparatively minor.

Indeed, the main difference between the two sets of path coefficients in Figure 6.5.1 is that the path from intelligence to education is rather larger in the DAS data than in the set of estimates derived from CPS-NORC data and other sources. An exaggeration of this path is precisely what we would expect if a measure of adult intelligence is used as a proxy for childhood intelligence. Apart from this difference, and the corollary reduction in the paths from socioeconomic background factors, the two sets of results exhibit a very nice replication indeed. It appears that the final model of ability and achievement describes features of the process of achievement that are pervasive in American society.

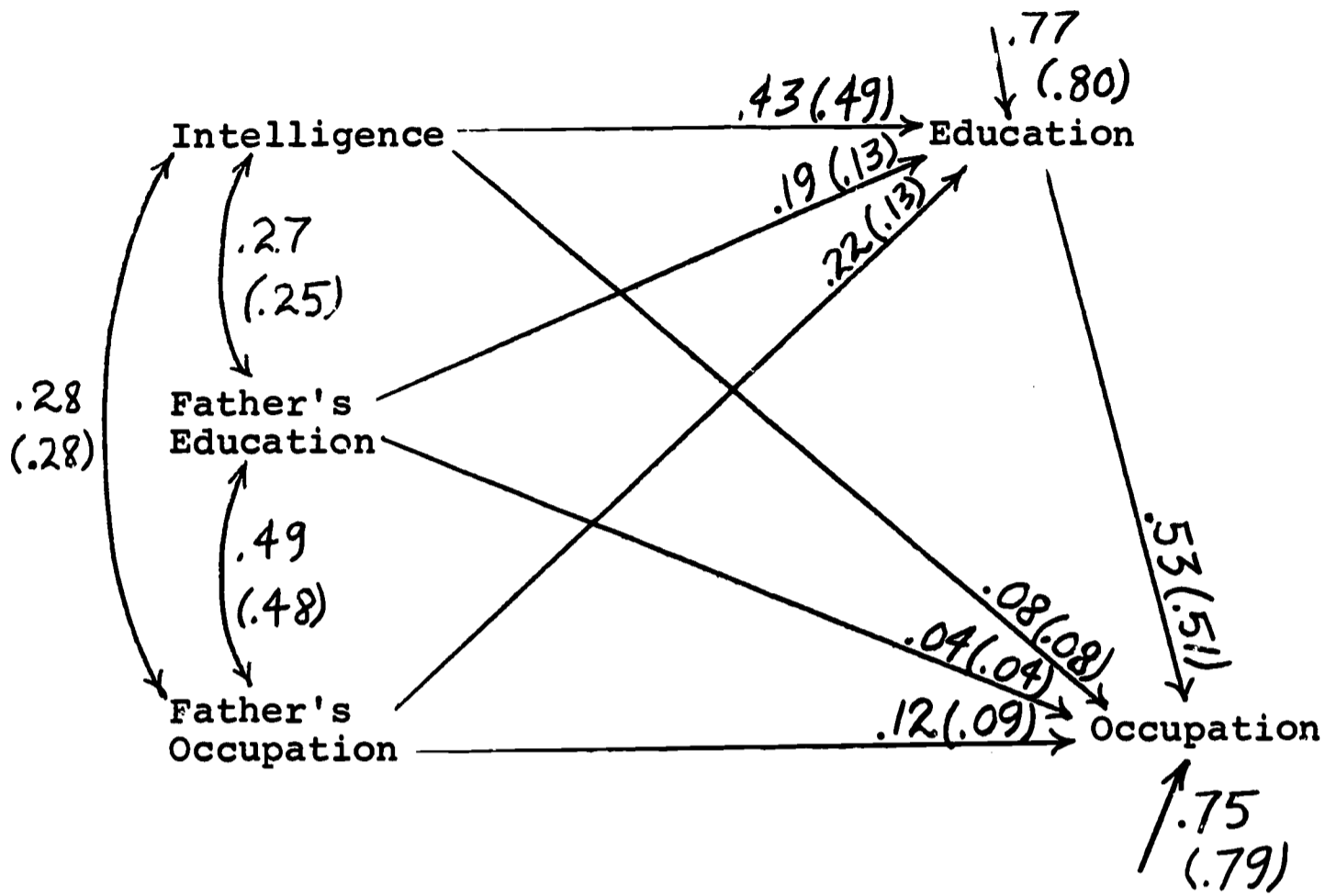

Figure 6.5.1.--Abridged Version of the Final Model of Ability and Achievement, with Path Coefficients Estimated for Two Populations. (Figures not in parentheses based on data summarized in section 6.4; figures in parentheses based on DAS data set.)

## CHAPTER 7

### INTERVENING VARIABLES, II: ASPIRATIONS AND MOTIVES

The general rationale for the class of variables studied in this chapter has been stated by Crockett (1966, p. 281):

When one asks why, given the presence of certain social structural conditions particular persons rise, fall, or remain stationary in the status system, personality characteristics immediately become relevant and important. Some sons of laborers become skilled workers, others do not; some sons of professionals descend into slightly skilled white-collar jobs, or into manual occupations, others do not. This variation in mobility among persons sharing similar social positions and influence requires attention to personality factors in mobility.

In this chapter we shall not attempt to construct or maintain a theoretically coherent set of distinctions among such concepts as aspiration, orientation, motivation, ambition, and the like. All such concepts seemingly refer to "dispositions" that are imputed to individuals by themselves or by observers. There is apparently a wide range of variation in regard to dispositions, from those that are more or less transitory, situationally conditioned, and specific to those that are enduring, resistant to change under alteration of conditions, and generalized. But frequently the investigator will wish to argue that a situationally specific intention, such as "college plans," is indicative of a more generalized and persistent orientation that he would call "educational aspiration," or even more broadly, "ambition" or "achievement orientation."

Insofar as such arguments are based on general theories in social psychology, the present work will have little to say about their validity--it is no part of our task to make a contribution to theory in that field. Instead, we wish to illustrate how such arguments may become relevant to the interpretation of particular bodies of data on socioeconomic achievement. Our claim is that making the argument explicit in the context of a definite model enables the investigator both to realize its implications more clearly and to ascertain whether these are consistent with the information at hand. In none of the examples considered here is any one interpretation uniquely indicated by the data, although some interpretations that might seem to represent viable alternatives ex ante turn out not to be viable ex post.



### 7.1. Measurement of Aspirations

Several sociological studies (see literature cited by Haller and Miller, 1963) have dealt with the occupational aspirations of teenagers. These studies typically relate level of aspiration to indicators of social background. In the absence of longitudinal data, however, they cannot provide information on the degree to which aspirations serve as the mediating link between background and achievement. Even so, we shall review briefly the materials available in certain of these studies. The primary purpose is to suggest that such materials can, in principle, be collected in a form suited to use in models of the kind studied here, although such has not been the practice in the past.

Stephenson (1957) secured data on father's occupation and respondent's occupational plans and aspirations from some 1,000 ninth-grade students in four "semi-industrial, medium-sized communities in New Jersey." The responses were classified into the six categories of the Alba Edwards socioeconomic classification of occupations. One table presents the bivariate frequency distribution of occupational plans by father's occupation, and another similarly shows occupational aspirations by father's occupation. Unfortunately, the detailed data are not shown by sex, so that the results are a mixture of relationships holding for males and females. Females reporting "marriage" as an occupational goal are excluded from consideration here.

To secure a compact reduction of Stephenson's data, the six occupation categories were assigned integer scores, 1 to 6, according to the conventional ordering from "unskilled" to "professional." Table 7.1.1 provides the summary statistics from regression analyses. It is noteworthy that the slope of "aspirations" on father's occupation is much lower than the slope of "plans" on father's occupation. The more realistic the response, the greater is the relationship to background. Moreover, plans are almost a whole step lower on this occupational scale than aspirations, although they are a step higher, on the average, than father's occupation.

The patterns just noted are likewise present in another body of material. Table 7.1.2 reproduces data from Empey's study (1956) of occupational aspirations and shows the regression coefficients we computed from these data. Empey asked a sample of seniors in high schools in the state of Washington in 1954 to indicate their occupational aspirations, both in terms of the occupations they would "prefer" to engage in and the ones they actually "anticipated" they would hold. The students also reported their fathers' occupations.

In scaling both father's occupation and student's occupational aspiration, Empey coded occupations to one of ten status levels. These levels were derived by merging the results of the North-Hatt and Smith studies of occupational prestige. From Empey's unpublished listing of occupations in the ten levels, we have estimated score ranges expressed in terms of both the North-Hatt metric and the metric of Duncan's

Table 7.1.1.--Summary of Regressions of Student's Occupational Aspirations and Plans on Father's Occupation, Based on Data of Stephenson (1957)

Item	Aspirations	Plans
Number reporting both aspirations (plans) and father's occupation	812	795
Mean, father's occupation (X)	3.12	3.16
Standard deviation, father's occupation	1.39	1.38
Mean aspirations (plans) (Y)	5.17	4.38
S.D., aspirations (plans)	1.25	1.37
Regression slope, Y on X	.127	.366
Intercept	4.77	3.23
Correlation coefficient	.141	.37
Correlation ratio, Y on X	.154	.382

socioeconomic index (which was originally scaled to reproduce the percentage of "excellent" or "good" ratings received by an occupation in the North-Hatt study). Since Empey considered not only the North-Hatt scores but also Smith's ratings, there are some overlaps between ranges of the adjacent levels on his composite scale.

It will be noted that the Empey status levels do not represent equal intervals on either the North-Hatt or the Duncan scale, although this is not necessarily in its disfavor. The more significant question for our purposes is the one of how statistics derived from his data may be compared with other data we are using.

We have no norms for aspiration data, and Empey does not provide distributions or variances of the aspiration scores in any event. We can, however, look at the distribution of fathers' occupations. The mean score of fathers' occupations on his scale is 4.86, which falls in the interval of 19-40 on the Duncan scale. The mean for all fathers in the OCG data is 26.8, while the mean for fathers of men who completed the 12th grade is 33.8. Although the comparison is necessarily crude, there is no evidence of serious disagreement with the OCG results. One standard deviation below the mean on Empey's scale corresponds roughly to a score of 18 on the Duncan scale and one standard deviation above the mean to about 69. Hence, in this portion of the scale the standard

Table 7.1.2.--Empey's Data on Occupational Aspiration, with Derived Statistics

Father's Status (X)	Range of Scores		Level of Aspiration (Y) <sup>c</sup>			
	North-Hatt metric <sup>a</sup>	Duncan metric <sup>b</sup>	"Preferred"		"Anticipated"	
			N	Mean	N	Mean
10 (high)	88-96	92-96	6	7.83	6	7.83
9	83-87	84-91	12	7.92	8	8.36
8	79-85	74-87	52	7.63	42	7.26
7	77-81	68-80	57	7.26	41	7.32
6	72-76	53-68	174	6.61	132	6.45
5	67-71	37-50	97	6.87	69	6.46
4	58-68	19-40	184	6.47	129	5.99
3	54-60	15-22	115	6.25	87	5.70
2	44-52	7-13	56	6.07	45	5.69
1 (low)	33-46	3-8	11	5.36	6	4.50
Total	...	...	764	...	565	...

Summary Statistics

Grand mean,	X	4.86	...	4.89	...
	Y	...	6.65	...	6.32
Standard deviation,	X	1.83	...	1.86	...
Regression,	Y on X		.2329		.3114
Intercept			5.52		4.80

<sup>a</sup>Albert J. Reiss, Jr., and others, Occupations and Social Status (New York: Free Press, 1961), Table II-9, pp. 54-57.

<sup>b</sup>Obtained from North-Hatt scores using transformation shown in ibid., Figure 1, p. 119 (see also Appendix Table B-1 for comparison of Duncan socioeconomic index and North-Hatt metric).

<sup>c</sup>Source: LaMar T. Empey, "Social Class and Occupational Aspiration: A Comparison of Absolute and Relative Measurement," American Sociological Review, 21 (December 1956), 703-709; data taken from Table 1 and unpublished listing of occupations.

deviation is equivalent to about 20 points on the Duncan scale. In the OCG sample, the standard deviation for all fathers was 21.5 and for fathers of high school graduates, 23.6. We may conclude that Empey's distribution is sufficiently similar to the implied OCG distribution to warrant rough comparisons.

The main statistics of interest are the two regression coefficients. "Preferred" level of aspiration on father's occupation has a slope of .23; "anticipated" level of aspiration a slope of .31. When the means in Table 7.1.2 are plotted they lie close to the regression line and show no systematic departure from it. Hence, we infer that a linear regression coefficient is a good summary of the average relationship of level of aspiration to level of origin.

For comparison, we may cite the regression of respondent's actual occupational status on father's occupational status for all men in the OCG sample reporting that their educational attainment was four years of high school or more. This coefficient is (computed somewhat roughly as) .325. We may now array the three coefficients:

"preferred" aspiration	.23
"anticipated" aspiration	.31
actual (OCG)	.325

Granted the imperfect comparability of Empey's data with the OCG statistics, the correspondence between "anticipated" slope of respondent's on father's status and the actual slope is quite remarkable. Evidently, there was more realism in the "anticipations" than in the "preferences."

These results, of course, do not imply that each student anticipated his occupation correctly. Instead, the import is that the aggregate of students implicitly understands fairly accurately the prevailing degree of relationship between origin and achievement.

It is unfortunate that we are unable to study the correlation coefficients, for lack of data on the dispersion of the aspirations. One might guess that the standard deviations of the two kinds of aspirations are somewhat less than that of the actual occupations these students were fated to follow. In this case, the correlation between aspiration and father's occupation need not be the same as that between actual occupation and father's occupation, which for the high-school graduate segment of the OCG sample comes out at .31. If, as is conjectured here, the standard deviation of aspirations is less than the standard deviation of actual achieved statuses, then the correlation between origin and aspiration would be somewhat higher than .3.

One other comparison between aspiration and reality is instructive. As Table 7.1.2 shows, the mean of the aspired occupations is rather higher than the mean of social origins. Since there is a net balance of upward mobility in American society, the direction of the

discrepancy is realistic. Its magnitude, however, may be exaggerated. The difference between "preferred" occupation and level of origin amounts to 98 per cent of one standard deviation of the distribution of origins, and the difference between "anticipated" occupation and level of origin is as great as 77 per cent of one standard deviation of the origin distribution. The OCG data show a somewhat more moderate amount of net upward mobility for men who were high school graduates: 58 per cent of one standard deviation of the distribution by father's occupational status.

If the OCG experience is prognostic of the outcome for the Washington seniors studied by Empey, a considerable number of the latter are likely to fall short of their aspirations, even though the majority will undergo intergenerational upward mobility. We see that a considerable amount of net upward mobility in a society does not guarantee that the prevailing levels of aspiration will be realized. Indeed, we might speculate that the prevalence of upward mobility tends to generate unrealistic aspirations and, perhaps, indirectly disappointment at failure to realize them.

One other significant set of information on the topic of this section is Turner's (1964) data on occupational aspirations of male high school seniors in selected schools in the Los Angeles area. Both parental occupations and the boys' anticipations of their "life work" were coded in terms of a nine-point scale intended to represent steps on a "prestige-subcultural" dimension of occupational standing. Turner presents (Table 9, p. 50) the median "aspiration" or "occupational ambition" of boys for each category of parental occupation. If this set of medians is assumed to be a set of means, we can compute the regression of aspiration on parental occupation, .4695. In Table 5 (p. 36) Turner shows the marginal frequency distributions of aspirations and parental occupations. From these we can compute the mean aspiration score as 5.8 with standard deviation 2.10 and the mean parental occupation score as 4.4 with standard deviation 2.20. Using the ratio of the two standard deviations, we can obtain from the regression slope the correlation between aspiration and parental occupation, which works out to be .491.

The regression of occupational ambition on background is considerably higher in Turner's data than in the data reported by Empey and Stephenson. It is difficult to be sure, however, whether this is due to the way in which the question was asked, the method of scoring occupations, or real differences in the populations under study. Turner (1964, p. 35) was quite explicit that his intention in wording the question on "life work" was to "lessen fantasy and wishful responses." Conceivably he was simply more successful in this aim than was Empey in asking for "anticipated" occupation or Stephenson in inquiring about "occupational plans."

## 7.2. Measurement of Plans

In many studies of educational opportunity, high school students are asked in their last year of attendance to state whether they plan to go to college. Such information on "college plans" often has to serve as a surrogate for actual data on post high-school educational attainment. The available evidence seems to indicate that "college plans" are a somewhat reliable indicator of actual college attendance, but it is obviously desirable to have the actual data on educational attainment in such form that it can be related to ability, family and community background, and like factors. Hence, the Wisconsin data on which Sewell has been reporting are an exceptionally valuable resource. A state-wide sample of high-school seniors whose plans were ascertained in 1957 were followed up to 1964 at which time their subsequent educational attainment was ascertained. The relevant data for present purposes include measures of the student's family's socioeconomic status, the student's intelligence, his statement in 1957 of plans to go to college, and the actual amount of education completed by 1964 (Sewell and Shah, 1967). Aside from establishing the degree of reliability of statements of college plans, the Sewell study permits analysis of how background factors condition the decision to attend and thereby actual attendance.

For males and females respectively, college plans correlate .67 and .78 with college attendance, .56 and .58 with college graduation, and .69 and .76 with total educational achievement. Thus plans are by no means a perfect predictor of actual outcome, while the authors' analysis suggests that background factors, in addition to their influence on the student's plan to attend college (as reported), also directly affect educational attainment. This interpretation is conveyed by the diagrams labelled "A" in Figure 7.2.1.

The purpose of this discussion is to explore an alternative interpretation of the same data. This alternative interpretation hinges upon the introduction into the causal scheme of a hypothetical variable, termed "latent decision." The argument for such a variable is two-fold. In the first place, the student's report on college plans may be somewhat unreliable, in the sense that for some fraction of students the investigator would have obtained a different report if he had asked the question, say, on Thursday rather than on Monday. It should be noted that in Sewell's data, "College Plans" is the response to a specific question on intentions, in contrast to the somewhat more ambiguous question on "Educational Aspirations" which is sometimes asked in similar surveys. It should, therefore, have higher reliability than the latter. Secondly, and more important, the actual decision to attend college need not be made at some fixed point in time, but can be postponed or accelerated. Moreover, at any given point, some students will not really know their own mind (a familiar example is the "undecided" column in straw vote investigations). We will, in effect, assume that a "true" decision has implicitly been reached by the student at the time he is interrogated about his plans--though not necessarily an irrevocable

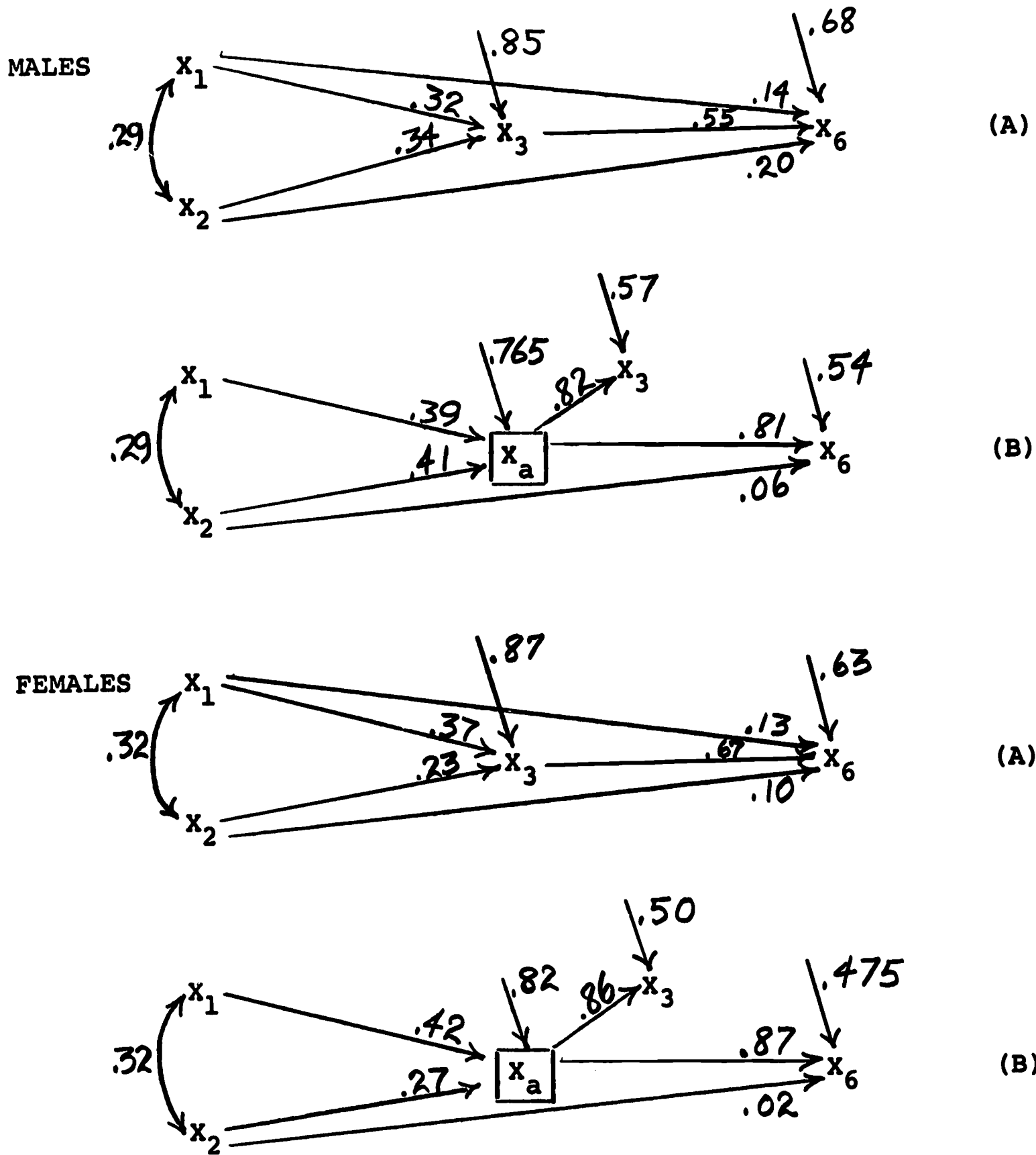

Fig. 7.2.1.--Alternative Interpretations of Sewell's Data on College Plans. (Variables:  $X_1$  is socioeconomic status,  $X_2$  is measured intelligence,  $X_3$  is college plans,  $X_6$  is educational attainment, and  $X_a$  is hypothetical variable, "latent decision.")

decision. The calculations we shall offer on this assumption take the diagrams labelled "B" in Figure 7.2.1 as the causal model.

The essential property of this model is that the "latent decision," symbolized by  $X_a$ , is taken to reflect the background variables (socioeconomic status and intelligence) as fully as one can consistently assume on the basis of the data. The first assumption explored, in fact, was that background affects attainment only by way of the "latent decision" to go to college. On this assumption, in Model B both  $p_{61}$  and  $p_{62}$  would be zero. The data do not permit this assumption. However, it is possible to set one of these paths equal to zero while allowing the other to take on whatever value is indicated by the data. While either  $p_{61}$  or  $p_{62}$  might be treated in this fashion, the interpretation seems easier to maintain with  $p_{61} = 0$  as in Model B.

Comparison of Model A with Model B for either males or females indicates the following features of the alternative interpretation.

College plans as reported are indeed a fallible indicator of "latent decision." The coefficient  $p_{3a}$  is .82 for males and .86 for females. If we were to assume that the only reason for an imperfect correlation between "latent decision" and reported college plans is response unreliability of the latter, we could compute as the reliability coefficient (in the sense of a test-retest correlation)  $p_{3a}^2 = .67$  for males and .74 for females. Interpreted as strict reliability coefficients, these are distressingly low. However, our interpretation would be that in addition to sheer response unreliability, the relationship between "latent decision" and college plans is attenuated by lack of crystallization of the latter.

A second observation is that the relative importance of factors in the decision is not altered by replacing  $X_3$  in Model A with  $X_a$  in Model B. For males in both models, intelligence has a just slightly larger influence than socioeconomic status, while the reverse is true for females. In this respect, as in several others, the alternative interpretation requires no revision of conclusions reached by Sewell and Shah.

In Model B, the effect of "latent decision" on actual attainment, as measured by  $p_{6a}$ , is much greater than the effect of college plans on attainment in Model A, as given by  $p_{63}$ . By the same token, the residual variation in educational attainment is much less in Model B than in Model A (see the comparisons in Table 7.2.1). The reader should be neither beguiled nor alarmed by the increases in the coefficients of determination achieved by adopting Model B as an alternative to Model A. Even assuming that the construct of "latent decision" correctly represents the function of a fully crystallized plan for further education, the fact that for males 29 per cent and for females 23 per cent of the variation in attainment remains unexplained is to be understood as allowing a considerable role for contingent factors to come into play after the decision is taken.



Perhaps the most interesting result of the alternative model is that it requires a "sleeper effect" of intelligence to account for the correlation of attainment with background. While small, this effect is not negligible for males. Even for females, the significant point is that the "sleeper effect" for intelligence appears despite the fact that socioeconomic status is more highly correlated with attainment than is intelligence, contrary to the case for males.

Table 7.2.1.--Coefficients of Determination for Models A and B

Model and Coefficient	Males	Females
<u>Model A</u>		
$R_{6(321)}^2$	.53	.60
$R_{3(21)}^2$	.28	.24
<u>Model B</u>		
$R_{6(a2)}^2$	.71	.77
$R_{a(21)}^2$	.41	.32

This result is, of course, implicit in the diagram used by Sewell and Shah, since  $p_{62}/p_{61} > p_{32}/p_{31}$  for both males and females. Again, there is no inconsistency between the two models, but Model B is useful in bringing out a point that might otherwise have been overlooked. The contrast between the two models, therefore, may serve "to illustrate the process of exploring different points of view which is one of the most useful features of path analysis" (Wright, 1960b, p. 445).

Note on the solution. While Model A is merely a recursive regression system, the asymmetrical character of Model B requires a somewhat roundabout method of solution. The relevant equations are written out below.

Known correlations in terms of unknown path coefficients and correlations:

$$[1] \quad r_{12} \text{ is given}$$

$$[2] \quad r_{13} = p_{3a} r_{a1}$$

$$[3] \quad r_{23} = p_{3a} r_{a2}$$

$$[4] \quad r_{16} = p_{6a} r_{a1} + p_{62} r_{12}$$

$$[5] \quad r_{26} = p_{6a} r_{a2} + p_{62}$$

$$[6] \quad r_{36} = p_{6a} r_{3a} + p_{62} r_{32}$$

Unknown correlations:

$$[7] \quad r_{a1} = p_{a1} + p_{a2} r_{12}$$

$$[8] \quad r_{a2} = p_{a1} r_{12} + p_{a2}$$

$$[9] \quad r_{a3} = p_{3a}$$

$$[10] \quad r_{a6} = p_{6a} + p_{62} r_{2a}$$

Solution routine:

$$\text{From [4] and [5], } p_{62} = \frac{r_{26} r_{a1} - r_{16} r_{a2}}{r_{a1} - r_{12} r_{a2}}$$

Substituting  $r_{a1} = r_{13}/p_{3a}$  and  $r_{a2} = r_{23}/p_{3a}$

$$\text{from [2] and [3], } p_{62} = \frac{r_{26} r_{13} - r_{16} r_{23}}{r_{13} - r_{12} r_{23}}$$

Inserting the solution for  $p_{62}$  into [4], [5], and [6], we obtain

expressions of the form,

$$p_{6a} r_{a1} = K_1, \quad p_{6a} r_{a2} = K_2, \quad \text{and} \quad p_{6a} r_{3a} = K_3,$$

where  $K_1$ ,  $K_2$ , and  $K_3$  are now known numbers.

Straightforward substitutions in [2] through [6] yield solutions for

$p_{3a}$ ,  $p_{6a}$ ,  $r_{a1}$  and  $r_{a2}$ , whence simultaneous solution of [7] and

[8] yields  $p_{a1}$  and  $p_{a2}$ , while [10] gives  $r_{a6}$ .

The residual paths are computed in the usual manner; for example, for

$$X_a \text{ the residual is } \sqrt{1 - p_{a1} r_{a1} - p_{a2} r_{a2}}.$$

### 7.3. Measurement of Motivation

For nearly two decades, social psychologists and psychologists have utilized the construct of achievement motivation as both a dependent and an independent variable. In studies of the former approach, achievement-related motivation was viewed as the product of specific child rearing practices within various socioeconomic categories or as a net resolution of family authority or power relations within the motivational dispositions of children. Investigations which followed the effects of achievement motivation back into the social structure typically involved dependent variables like educational performance or occupational attainment.

In 1962, Harry J. Crockett published his often-cited article which associated achievement motivation with differential occupational mobility (intergenerational) by social class. He hypothesized that the strength of achievement motivation would correlate positively with upward mobility and negatively with downward mobility. Later the substance of his article will be elaborated and assessed. For the moment, however, let us consider the theoretical connection between achievement motivation and its specific behavioral manifestation, i.e., occupational mobility.

Atkinson's (1957) theory of achievement motivation provides the theoretical connection. According to the theory, achievement motivation is the product of (1) a basic motive to achieve at tasks involving evaluations of successes or failures (M); (2) the incentive value of the task, i.e., its prestige value as perceived by the actor (I); and (3) the complement of incentive value, the subjective probability of success at the task (P). Symbolically expressed, achievement motivation =  $(M) \times (I) \times (P)$ , where  $I = 1 - P$ . This representation allows the level of achievement motivation to vary with specific tasks and situations (through factors I and P), as well as with motive strength differentials. The optimal situation for all strengths of M obtains when  $P = .50$ , and where by substitution,  $I = .50$  as well. Hence for moderately difficult tasks with moderate attraction and a constant motive strength, manifest motivation is maximized.

In speaking of real-life situations which may call out behavioral expression of the achievement motive, Atkinson notes that the occupational structure (seen as a prestige ladder) closely approximates a series of increasingly difficult tasks to perform; in fact, it is similar to a ring-toss game. A person relatively high in the motive to achieve (M) should optimize the incentive value and the probability of success by choosing an occupation of moderate difficulty ( $P = .50$ ) with respect to his subjective assessment of the occupational structure and his own abilities. Supposedly, persons with higher levels of M are more circumspect about their aspirations than are those lower on this motive and/or higher in fear of failure. At any rate, the achievement motive entails needs to succeed at tasks involving personal evaluation. Such seems to be the situation with occupational choice and advancement.

Crockett's article (1962) based its theory on Atkinson's model. The data came from the Survey Research Center (SRC) of The University of Michigan Project 422 (Modern Living Study) conducted by Gerald Gurin, Joseph Veroff, and Sheila C. Feld in March 1957. The 2,460 original respondents comprised a national probability sample of persons 21 years of age or older residing in private households in the United States. As part of the psychodynamic assessment of the sample, TAT protocols were gathered from a random subsample, of which 715 were males; all protocols were scored for achievement (n Ach) affiliation (n Affil), and power (n Power). Crockett eliminated 118 from the 715 males because of inadequate responses, leaving 597 potential respondents. Further deletions included 193 with farm background or residence, 23 unascertained father's occupations, 2 unascertained respondent's occupations, and 11 student respondents, leaving a total  $N = 368$ . In our analysis of Crockett's data, an additional case had to be dropped because of wild punches on the data card. Our initial working  $N$  for Crockett's data was 367.

Crockett and two colleagues coded the occupational responses according to the 1947 North-Hatt prestige scores, reporting intercoder reliability of 80 per cent and a correlation of prestige scores of  $r = .85$ . For analytic purposes, Crockett created four occupational prestige categories based on father's occupation: high (N-H 78-93), upper middle (N-H 69-77), lower middle (N-H 61-68) and low (N-H 33-60). Relating n Ach score on the TAT measure to the percentage of respondents above and below their respective father's occupational score within each of the four prestige categories, Crockett reported that only for the lower middle and low categories was n Ach significantly related to intergenerational upward mobility; in no category did n Ach relate to downward mobility. Similar associations were constructed for n Affiliation and n Power (scored from the same TAT data). In both cases Crockett concluded that n Ach is the better specific motive for the explanation of occupational mobility, and that the relationship between n Ach and mobility cannot be explained on the basis of a strong, general motivation factor.

Crockett's discussion of his findings pointed to the "sociological naivete" of Atkinson's mobility thesis. Since individuals coming from higher prestige backgrounds (father's occupation) are more likely to attend college or attain specialized training which facilitates upward mobility than are persons from lower status backgrounds, one's upward mobility from middle and upper middle statuses depends less on one's psychological traits (n Ach) than does one's upward mobility from lower middle and low statuses. Lacking the sociological advantages of higher strata, the lower strata depend more on their psychology for occupational mobility.

Crockett's thesis at once appealed to our search for psychological components which aid in the transmission of occupational status from one generation to the next. Having secured his data, we ran some preliminary frequency distributions to compare with the OCG sample. The peculiar shape of Crockett's occupational distribution (see Table 7.3.1,

Table 7.3.1.1.--Frequency Distributions of Respondents' and Fathers' Occupational Statuses, SRC Data  
Used by Crockett

SES Code Intervals	Occupational Status		Whole Data		Located Data		Not Located		After Recode (Located Data Only)	
	North-Hatt	Respondent	Respondent	Father	Respondent	Father	Respondent	Father	Respondent	Father
90+	87-89	8	11	6	9	2	8	2	9	
85-89	84-86	12	8	8	5	4	2	3	2	
80-84	81-83	22	6	18	6	4	17	0	4	
75-79	80	3	1	3	1	0	9	0	5	
70-74	78-79	14	5	9	4	5	9	1	9	
65-69	76-77	14	6	13	5	1	16	1	10	
60-64	74-75	0	0	0	0	0	19	0	21	
55-59	73	29	14	26	10	3	6	4	7	
50-54	71-72	7	2	7	2	0	22	0	25	
45-49	70	0	0	0	0	0	16	0	15	
40-44	68-69	129	176	110	152	19	28	24	14	
35-39	67	0	0	0	0	0	18	0	25	
30-34	64-66	6	5	5	4	1	24	1	24	
25-29	62-63	21	9	19	7	2	12	2	15	
20-24	59-61	44	47	38	43	6	20	4	21	
15-19	54-58	13	14	11	11	2	57	3	63	
10-14	49-53	24	22	24	18	0	15	4	15	
5-9	38-48	20	41	16	37	4	13	4	14	
0-4	20-37	1	0	1	0	0	3	0	16	
<b>TOTAL</b>		<b>367</b>	<b>367</b>	<b>314</b>	<b>314</b>	<b>53</b>	<b>314</b>	<b>53</b>	<b>314</b>	<b>314</b>

"whole data"), which displayed a prominent overrepresentation in the North-Hatt interval 68-69, provoked two questions: (1) Was the strange distribution of occupations a product of the elimination of cases from the subsample? (2) Was it the product of faulty coding procedures?

In order to answer these questions we procured the interview schedules from the Survey Research Center (SRC) storage. Unfortunately 14 per cent of the original Crockett set could not be located, leaving a working  $N = 314$ . Tables 7.3.1 and 7.3.2 summarize the comparison of the located data with the whole set. By inspection one sees a roughly analogous distribution of fathers' and sons' occupations in Table 7.3.1, while the means and standard deviations of occupational and educational variables in Table 7.3.2 match closely. On the basis of these comparisons, and in the face of necessity, we used the located set as a representation of Crockett's data.

Proceeding to recode the two occupational items on each schedule, we utilized a modified form of the U.S. Census coding procedures for occupations. Whereas the Census specifies a four-fold class-of-worker scheme, we collapsed this into a simple dichotomy: self-employed or not self-employed. Apart from this slight change, we followed the Census conventions of using a three-digit code for industry and a three-digit code for occupation. Thus we encoded each response into seven digits and assigned the specific codes for each Census line as listed in the 1960 edition of the Alphabetical Index of Occupations and Industries.

Such a coding procedure enabled us to assign Duncan status scores to all occupation titles, since a score exists for all census lines. This technique of using the census as the basic coding device enlarged the pool of titles to which scores could be assigned directly, rather than through the process of interpolation between titles (as would have been the case had we duplicated Crockett's use of the ninety titles on the North-Hatt list). In addition we translated the derived SES codes into their North-Hatt equivalents, as these are defined by the S-shaped curve reported elsewhere (Reiss, 1961, p. 119). (We also converted Crockett's own North-Hatt codes to the Duncan SES metric, using this same curve.) Finally, to each census title was attached a 1965 NORC prestige code (based on unpublished work of Hodge, Siegel, and Rossi).

The recoding operations were conducted by personnel of the Population Studies Center (PSC) of The University of Michigan. In total, six persons were involved in the process, but the great majority of the task was done by just three persons. An attempt to evaluate inter-coder agreement on assignments indicated a figure of about 85 per cent.

Recoding allowed for the following comparisons: (1) We compared Crockett's distribution of occupational SES scores (vis-à-vis his coding procedures) with our distribution of SES scores (vis-à-vis the PSC coding). This comparison helps answer the questions about Crockett's sample, i.e., if his peculiarly shaped occupational distribution is a

Table 7.3.2.--Means and Standard Deviations of Occupational and Educational Variables

Variable	SRC						OCG*					
	Respondent			Father			Respondent					
	Whole data Std. Mean dev.	Located data Std. Mean dev.	Whole data Std. Mean dev.	Located data Std. Mean dev.	Located data Std. Mean dev.	Std. Mean dev.	Std. Mean dev.	Std. Mean dev.				
Crockett's coding into 1947 North-Hatt scores	67.4	10.0	67.0	10.0	65.1	9.7	64.8	9.7	--	--	--	
Transformation of Crockett's coding into Duncan SES metric	42.7	22.7	41.8	22.2	37.3	20.5	36.7	20.2	--	--	--	
PSC coding into Census and transformation to Duncan SES metric	--	--	41.0	23.8	--	--	36.2	23.1	40.1	24.7	33.1	22.8
PSC coding into Census and transformation to 1965 NORC scores	--	--	40.6	14.6	--	--	39.8	14.5	--	--	--	--
Education	4.8	1.5	4.7	1.5	--	--	--	--	4.7	1.7	--	--

\*Nonfarm background males ages 20-64.

result of his elimination of cases or of his coding procedures. We have held constant the occupational metric of both coding tasks to examine the effects of independent coding. (2) Analogously we compared the coding procedures holding constant the prestige metric. While the 1947 North-Hatt and the 1965 NORC metrics are not identical, Figure 7.3.1 indicates that the differences are not so great as to jeopardize our comparison. (3) Not without some slippage, we compared the redistribution of occupational scores with the OCG distributions for nonfarm white males ages 20-64 in 1962. This latter comparison speaks directly to the question of the representativeness of Crockett's sample.

Considering the last-mentioned comparison, one finds in Table 7.3.1 the redistribution of fathers and sons after recoding their occupations (last two columns); the array is more evenly distributed over all SES intervals. Table 7.3.2 shows that the mean respondents' occupational SES scores for the located Crockett data and the OCG data as 41.0 and 40.1, with standard deviations 23.8 and 24.7, respectively. For fathers, the Crockett data indicate a mean of 36.2 and a standard deviation of 23.1; the OCG equivalents are 33.1 and 22.8.

From these data we conclude that Crockett's elimination of cases from his sample did not appreciably bias the shape of his occupational distributions. Still, why should Crockett have over 200 more fathers and sons in the North-Hatt interval 68-69 than were there after recoding? Whereas Crockett placed 110 respondents and 152 fathers (located data) in the North-Hatt interval 68-69, upon recoding we assigned only 28 respondents and 14 fathers to this interval (see Table 7.3.1). Table 7.3.3 shows the redistribution of Crockett's cases which were coded 68 or 69 by him. Only 6 respondents and 8 fathers remained, while the others more or less randomly entered different intervals. Apparently something rather peculiar occurred in Crockett's coding process.

One possible source of difficulty which Crockett could have encountered was the sheer ambiguity of the responses on the interview schedules. To test this possibility, we classified all responses to occupational items with respect to degree of ambiguity, the latter being determined by the relative amount of information transmitted and the subsequent ability to assign a specific SES code. Three categories were created:

Essentially no ambiguity (regarding SES code assignment)

Appreciable ambiguity

Essentially arbitrary decision required

Table 7.3.4 indicates that among the located schedules from Crockett's data, about 90 per cent of respondents' and 80 per cent of fathers' occupational items are codable into SES scores with little ambiguity; nearly 5 per cent of respondents' and 10 per cent of fathers' items can be scored with appreciable ambiguity, leaving just 5 per cent of the respondents' and 10 per cent of father's items to be assigned SES scores by some mechanical, arbitrary means. Hence, there appears to be no more than a tolerable level of intrinsic ambiguity in the interview data.



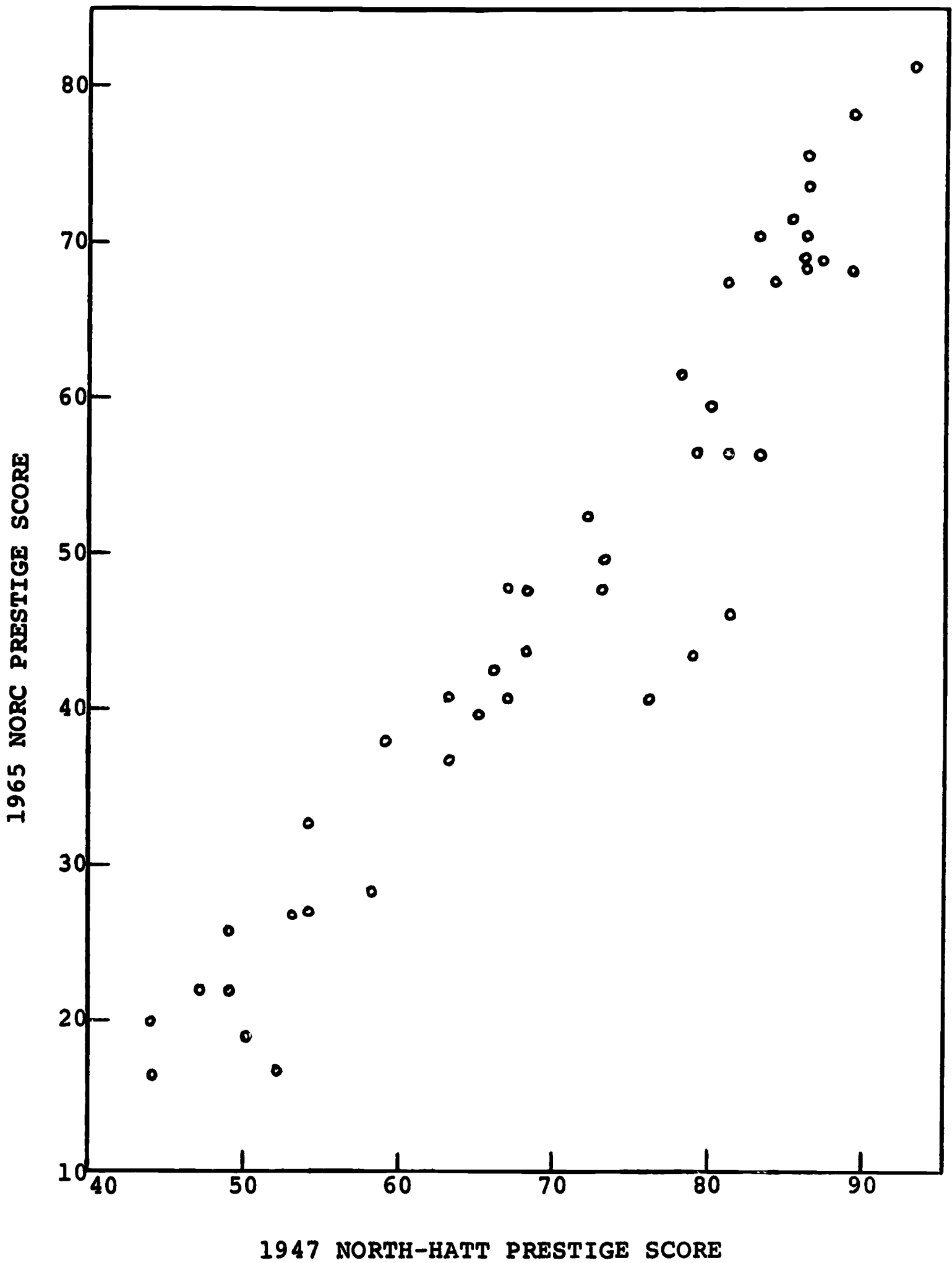

Figure 7.3.1.--Scatter Plot of 1965 NORC on 1947 North-Hatt Scores for 44 Matching Titles.

Table 7.3.3.--Redistribution of Crockett's North-Hatt Codes 68-69  
(Located schedules only)

Occupational SES Intervals	Respondent			Father		
	Total	Code 68	Code 69	Total	Code 68	Code 69
90+	**	**	**	**	**	**
85-89	**	**	**	**	**	**
80-84	1	0	1	1	0	1
75-79	3	1	2	0	0	0
70-74	5	2	3	3	0	3
65-69	6	3	3	5	4	1
60-64	7	2	5	16	2	14
55-59	5	2	3	6	2	4
50-54	8	4	4	10	0	10
45-49	9	8	1	13	8	5
40-44	<u>6</u>	<u>3</u>	<u>3</u>	<u>8</u>	<u>6</u>	<u>2</u>
35-39	8	6	2	14	6	8
30-34	14	14	0	19	13	6
25-29	8	8	0	11	11	0
20-24	5	4	1	7	6	1
15-19	23	21	2	32	30	2
10-14	0	0	0	7	5	2
5-9	2	1	1	0	0	0
0-4	**	**	**	**	**	**
Total	110	79	31	152	93	59

Table 7.3.4.--Distribution of Occupational Response Items in Table 7.3.3 by  
Estimated Ambiguity

Degree of Ambiguity	Respondent			Father		
	Total	Code 68	Code 69	Total	Code 68	Code 69
Essentially no ambiguity (re. SES code)	100	70	30	129	81	48
Appreciable ambiguity	5	4	1	10	8	2
Essentially arbitrary decision required	5	5	0	13	4	9
Total	110	79	31	152	93	59

Another possible source of error might have been scoring procedures by coders. However, Crockett reports an intercoder reliability of about 80 per cent in the assignment of North-Hatt scores by three sociologists.

Having eliminated sampling, ambiguity, and personal biases as major contributing factors to the sharply peaked occupational distribution in Crockett's data, we suggest that this result may have issued from Crockett's coding manual and from the code itself. The North-Hatt list contains just 90 titles, leaving gaping holes in the occupational structure in which subjective (and often quite arbitrary) placements increase error. While the conventions which coders employ to score non-matching titles may or may not be specified, surely the Census occupation-industry codes and procedures require and provide more information than the North-Hatt scheme (North-Hatt scoring requires one piece of information while the Census considers three: class of worker, industry, occupation). Clearly, however, the Duncan occupational SES score equivalents to Census lines were not available for Crockett's use. Had they been available and utilized, and given the change in the occupational distributions which were noted, one might ask if any substantive changes would be required in Crockett's thesis about the role of the three motives (n Ach, n Affil, n Power) in intergenerational mobility.

Table 7.3.5 provides insight into the effects of recoding on the size of zero-order correlation coefficients between mobility variables. Notice that a comparison of variables  $C_3$  and  $P_{10}$  as well as of  $C_4$  and  $P_{11}$  allows for an assessment of our recoding procedures of sons' and fathers' occupations. Variables  $C_3$  and  $C_4$  take Crockett's coding and transform his assigned North-Hatt scores to the metric of occupational SES codes; variables  $P_{10}$  and  $P_{11}$  result from our coding of questionnaire items into the Census classification and the transformation of these into equivalent SES codes. Thus the same metric applies across all four variables ( $C_3$ ,  $C_4$ ,  $P_{10}$ ,  $P_{11}$ ), and any differences in correlations using variable  $C_3$  rather than  $P_{10}$ , or  $C_4$  rather than  $P_{11}$ , with a second variable are due to the effects of the coding methods employed.

Likewise a comparison of variables  $C_1$  and  $P_{12}$  as well as  $C_2$  and  $P_{13}$  illustrates the coding effect, holding a prestige metric constant (North-Hatt and 1965 NORC).

The correlations between variables  $C_3$  and  $P_{10}$  (.64) and  $C_4$  and  $P_{11}$  (.62) measure a kind of "inter-method reliability" for sons' and fathers' occupational items. The slightly lower "reliability" with responses to fathers' occupations may mark greater arbitrariness in the assignment of codes. While the difference in the magnitude of correlations is slight indeed, greater ambiguity was noted in responses to fathers' occupation items than to sons' (see Table 7.3.4). The rather low magnitude of "inter-method reliability" (holding SES metric constant) does reflect the differences in coding procedures and the nature of the coding schemes as outlined above. In this connection, see McTavish (1964).

Table 7.3.5.--Zero-order Correlation Matrix for 314 Located Schedules

Variable <sup>a</sup>	Variable (see stub)												
	C <sub>1</sub>	C <sub>2</sub>	C <sub>3</sub>	C <sub>4</sub>	C <sub>5</sub>	C <sub>6</sub>	C <sub>7</sub>	C <sub>8</sub>	P <sub>9</sub>	P <sub>10</sub>	P <sub>11</sub>	P <sub>12</sub>	P <sub>13</sub>
<u>Crockett Coding (C)</u>													
C <sub>1</sub> R's Occupation (North-Hatt Prestige)	--	.250	.972	.264	.367	.097	.105	-.047	.382	.629	.224	.681	.167
C <sub>2</sub> Father's Occupation (North-Hatt)	--	--	.268	.963	.206	.083	.056	-.022	.218	.209	.609	.230	.643
C <sub>3</sub> R's North-Hatt to Duncan metric	--	--	--	.284	.383	.107	.099	-.053	.401	.637	.257	.683	.185
C <sub>4</sub> Father's North-Hatt to Duncan metric	--	--	--	--	.208	.085	.042	-.013	.220	.235	.615	.267	.651
C <sub>5</sub> R's Education	--	--	--	--	--	-.001	-.009	-.134	.977	.529	.322	.450	.194
C <sub>6</sub> R's Achievement	--	--	--	--	--	--	-.057	.020	.001	.122	-.044	.115	-.047
C <sub>7</sub> R's n Affiliation	--	--	--	--	--	--	--	-.088	.014	.063	.029	.094	-.000
C <sub>8</sub> R's n Power	--	--	--	--	--	--	--	--	-.123	-.022	-.005	.026	.003
<u>PSC Coding (P)</u>													
P <sub>9</sub> R's Education (OCG intervals)	--	--	--	--	--	--	--	--	--	.523	.321	.462	.189
P <sub>10</sub> R's Occupation SES (Duncan metric)	--	--	--	--	--	--	--	--	.60*	--	.282	.835	.191
P <sub>11</sub> Father's Occupation SES (Duncan metric)	--	--	--	--	--	--	--	--	.41*	.37*	--	.255	.824
P <sub>12</sub> R's Occupation (1965 NORC Prestige)	--	--	--	--	--	--	--	--	--	--	--	--	.174
P <sub>13</sub> Father's Occupation (1965 NORC Prestige)	--	--	--	--	--	--	--	--	--	--	--	--	--

\*OCG nonfarm age 20-64.

<sup>a</sup>In the body of the text, variables will be denoted by coding and number (e.g., C<sub>2</sub>, P<sub>10</sub>); correlations and paths denoted only by number (e.g., r<sub>1,10</sub>, P<sub>56</sub>).

With respect to the intergenerational correlation of occupations of father and son, recoding shows little difference:  $r_{3,4} = .284$  and  $r_{10,11} = .282$ . Other zero-order correlations are affected, however. The correlation of respondent's occupational SES with his education (recoded from Crockett to conform to categories compatible with our other research) change from  $.401$  ( $r_{3,9}$ ) to  $.523$  ( $r_{10,9}$ ). Fathers' occupational SES correlates with sons' education at  $.220$  ( $r_{4,9}$ ) and at  $.321$  ( $r_{11,9}$ ).

These changes in the size of zero-order correlations are attributable in part to the greater variability in the occupational distributions under our coding scheme than under Crockett's. Thus recoding raises the correlation of occupational SES with variables like education and the achievement motive ( $n$  Ach); the correlations of occupational variables remain about the same.

Rather than a comparison of zero-order correlations, a better answer to the question about substantive changes in Crockett's thesis is provided by path analysis and path diagrams. Figures 7.3.2 through 7.3.5 illustrate one interpretation of the causal influences on R's occupational status. On the interpretation represented by these path diagrams, son's occupational status (SES) depends directly upon father's occupation, son's education, and his  $n$  Ach, and indirectly upon each of the latter (taken singly) through each of the remaining two independent variables. Finally a residual with coefficient  $u$  affects the value of respondent's SES, but the model assumes the residual to be statistically uncorrelated with the influences of the three major independent variables. The values attached to the paths are net partial regression coefficients in standard form. Values on curved, two-headed arrows are zero-order correlation coefficients.

Figures 7.2.2 and 7.2.3 compare the path coefficients derived from the calculations based on the transformation of Crockett's North-Hatt codes into the occupational SES metric (Figure 7.2.2) and on our recoding into the census scheme and the occupational SES equivalents. The multiple  $R^2$  in Figure 7.2.3 ( $.310$ ) indicates that recoding Crockett's data actually allows greater prediction of respondent's occupational SES than Figure 7.3.2 ( $R^2 = .198$ ); recoding increases the explained variance in respondent's SES by 11 per cent. Although the relative importance of the three independent variables does not change in the process of recoding, the absolute sizes of the path coefficients are noticeably different. In fact the effect of respondent's  $n$  Ach increases from  $.090$  to  $.128$ , while the influence of father's occupational status declines to virtually the same value (from  $.206$  to  $.131$ ). Education remains the most important factor in the diagram. The increment in the relative effects of  $n$  Ach in the mobility process as illustrated in the diagrams can be attributed to the slightly negative correlation between father's occupation and son's  $n$  Ach in Figure 7.3.3. In Figure 7.3.2,  $r_{4,6}$  is equally small in magnitude but positive in sign.

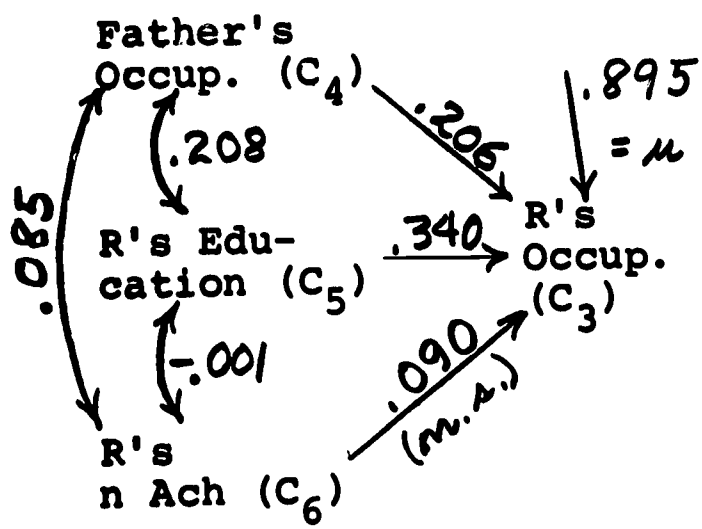

$$R = .445$$

$$R^2 = .198$$

Figure 7.3.2.--Crockett Coding Transformed into Duncan Occupational SES Metric.

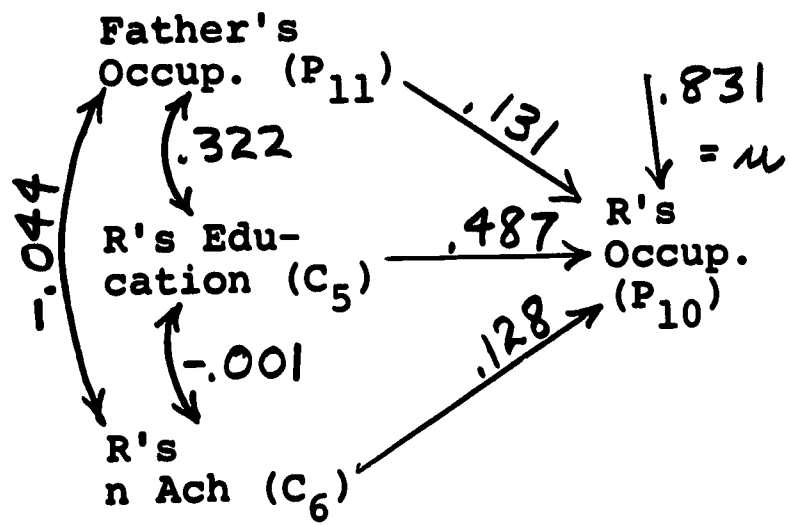

$$R = .557$$

$$R^2 = .310$$

Figure 7.3.3.--PSC Coding into Census and Occupational SES Metric.

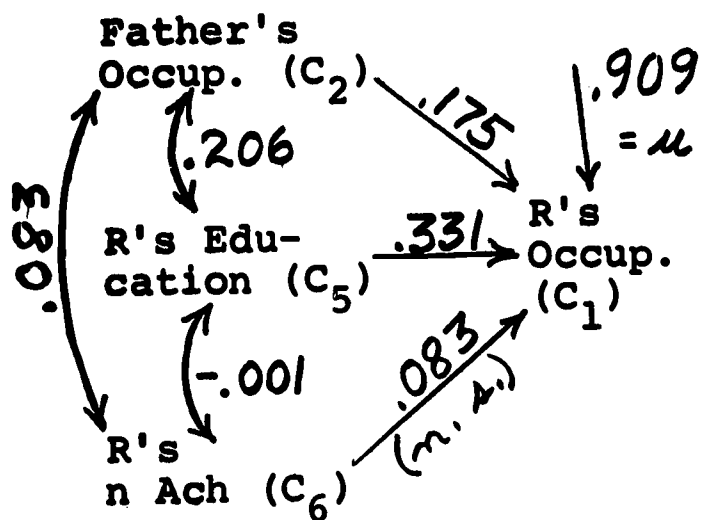

$$R = .416$$

$$R^2 = .173$$

Figure 7.3.4.--Crockett Coding Using 1947 North-Hatt Prestige Metric.

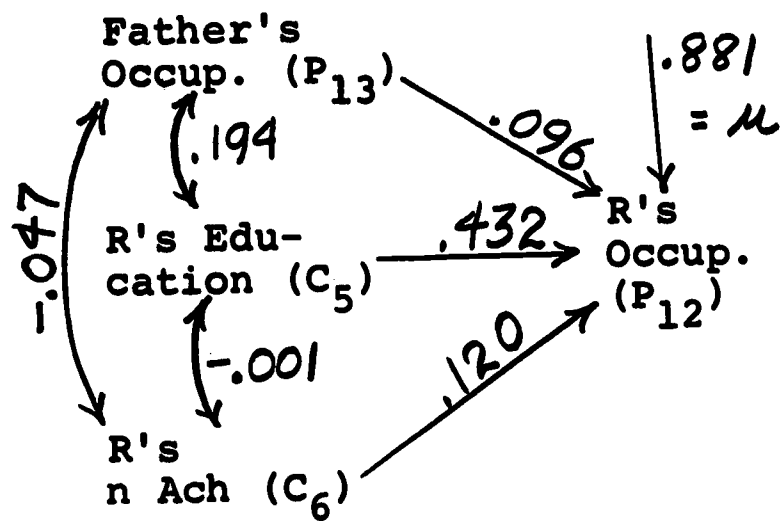

$$R = .474$$

$$R^2 = .225$$

Figure 7.3.5.--PSC Coding into Census and 1965 NORC Prestige Metric.

Figures 7.3.4 and 7.3.5 also illustrate the effects of recoding but they employ the 1965 NORC prestige metric. Parallel results ensue as one moves from Figure 7.3.4 (Crockett's coding) to Figure 7.3.5 (PSC coding). Again  $R^2$  increases over the two figures, while the relative effects of  $n$  Ach surpass those of father's occupational status in Figure 7.3.5.

These two sets of figures demonstrate the differences which recoding (or two different coding schemes) introduce in causal diagrams of the mobility process. In fact, our coding scheme increased the importance of  $n$  Ach in the process of occupational stratification above the level of importance which Crockett's data (with his coding) could produce. With this in mind we investigated the relative importance of each of the motives in Crockett's study ( $n$  Power,  $n$  Affil,  $n$  Ach) as they relate to respondent's education and his current occupational status.

Figures 7.3.6 and 7.3.7 reveal the differences in causal diagrams which derive from the two methods of coding occupations. Figure 7.3.6 illustrates the model via a transformation of Crockett's North-Hatt coding into the Duncan SES metric equivalents; Figure 7.3.7 shows the process as an outcome of PSC coding in the Duncan metric. The essence of these two figures is that different causal inferences are made as a result of recoding Crockett's data.

While the comparable path coefficients with respect to respondent's education remain the same over the two figures, the paths to his occupational SES contain an ironic finding. If Crockett had employed both the Duncan SES metric and a causal model like these path diagrams, he would have reached different conclusions about the relative importance of the three motives as influences on mobility.

In Figure 7.3.6 the paths  $p_{37}$  (.099) and  $p_{36}$  (.096) denote the same relative effect on respondent's occupational SES for his  $n$  Affiliation ( $C_7$ ) as for his  $n$  Achievement ( $C_6$ ). Crockett states that  $n$  Ach plays the larger role in mobility and then only in the lower strata of the occupational structure (where the positive effect of father's status is less great). The need for power ( $n$  Power) contributes virtually no effect in Figure 7.3.6 ( $p_{38}$ ). Son's education ( $C_5$ ) and father's occupational status ( $C_4$ ) are the strong variables in this model ( $p_{35} = .343$  and  $p_{34} = .200$ ).

Figure 7.3.7 (with PSC coding) supports Crockett's conclusions about the greater importance of  $n$  Ach over  $n$  Affil in occupational mobility. In fact,  $p_{10,7}$  and  $p_{10,8}$  fail to achieve significance (twice the standard error by convention), illustrating the lesser importance of  $n$  Affil ( $C_7$ ) and  $n$  Power ( $C_8$ ) respectively. The need for achievement ( $C_6$ ) slightly exceeds father's occupational SES ( $P_{11}$ ) in influencing son's current occupational status ( $P_{10}$ ) with  $p_{10,6} = .131$  and  $p_{10,11} = .126$ , while son's education ( $C_5$ ) clearly remains the dominant variable in the model ( $p_{10,5} = .496$ ). With respect to respondent's education and

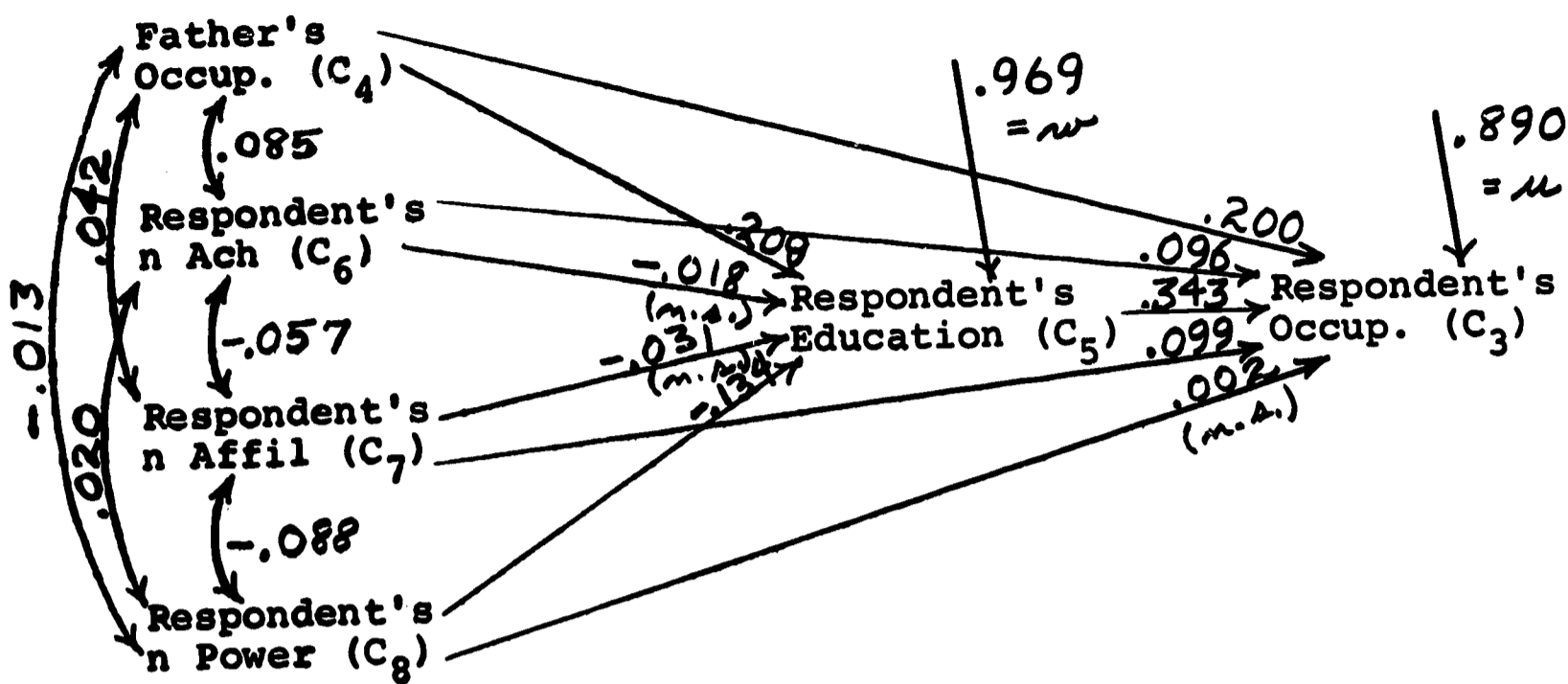

Figure 7.3.6.--Crockett Coding Transformed into Duncan Occupational SES Metric.  $R_5(4678) = .248$  and  $R^2 = .062$ .  
 $R_3(45678) = .456$  and  $R^2 = .208$ .

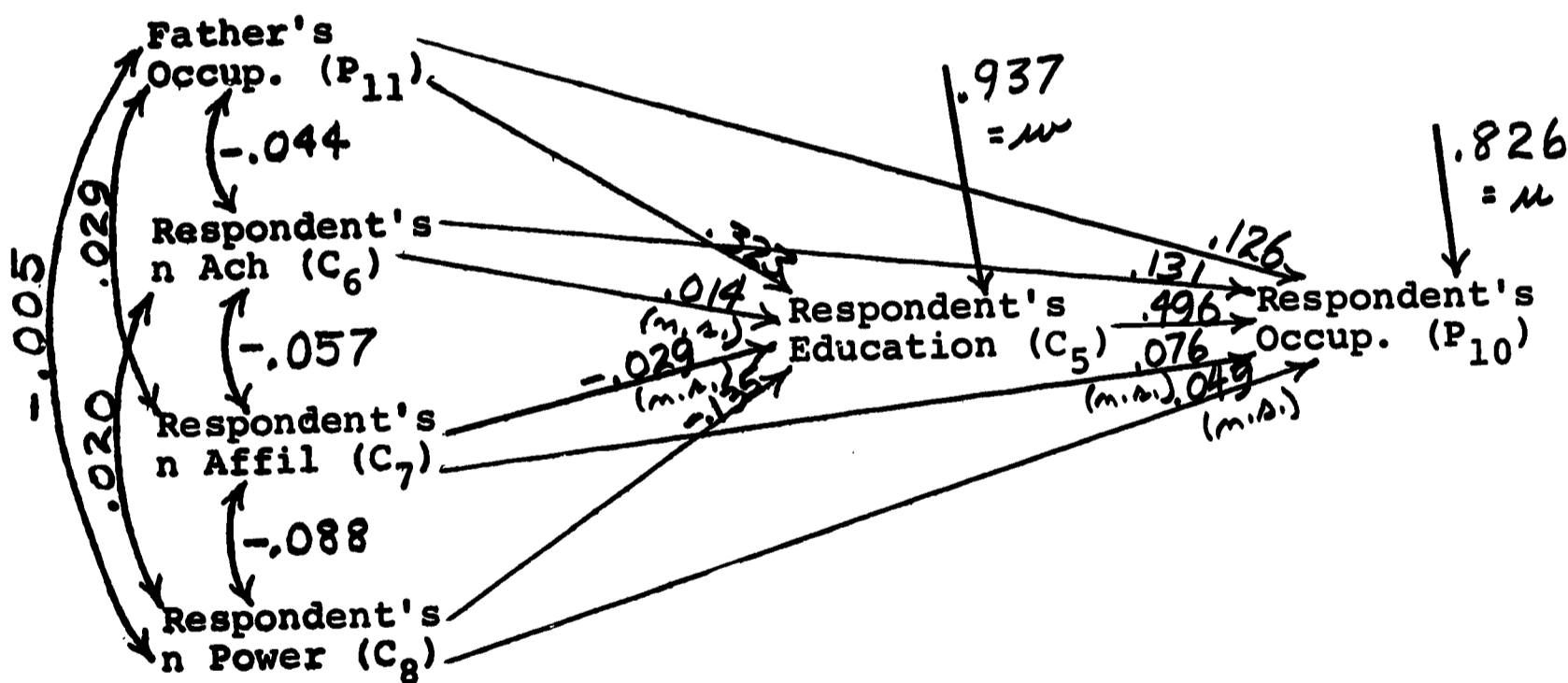

Figure 7.3.7.--PSC Coding into Census and Occupational SES Metric.  $R_5(678,11) = .350$  and  $R^2 = .122$ .  
 $R_{10}(5678,11) = .564$  and  $R^2 = .318$ .



his SES as dependent variables, the multiple  $R^2$ 's in Figure 7.3.7 are greater than in Figure 7.3.6:

$$R_{5(4,6,7,8)}^2 = .062 < R_{5(6,7,8,11)}^2 = .122$$

and  $R_{3(4,5,6,7,8)}^2 = .208 < R_{10(5,6,7,8,11)}^2 = .318.$

Thus, 6 per cent more variance in education and 12 per cent more variance in son's SES is explained in Figure 7.3.7 than in Figure 7.3.6. These increases in explained variance accrue as error is reduced (residual paths  $w$  reduced from .969 to .937 and  $u$  from .890 to .826).

Paradoxically, Crockett may have been correct about the significance of  $n$  Ach for occupational mobility. However, if he had employed a causal model with his coded data (as in Figure 7.3.6), his conclusions about the salience of the motivations for affiliation and achievement would have been obscured. Recoding the occupational data (as described above) enhances the role of a motive component ( $n$  Ach) in explaining the process of mobility.

Of course, this conclusion depends on the acceptance of the particular causal scheme of Figures 7.3.6 and 7.3.7. This scheme appears to be as close as one can get to a path diagram conforming to the way in which Crockett originally looked at the problem. There are, however, alternative points of view. For example, given that respondent's current occupation is measured contemporaneously with the projective indicators of motivation, a strong rival hypothesis is that occupational achievement causes motivation (as measured) rather than vice versa.

In conclusion, the method which is employed to code occupations may reshape the inferences (both correlational and causal) drawn from research. This effect is independent of intercoder "reliability" within the method used and of the basic metric of the scoring system used in recoding (although both of the latter can and do influence results in their own right). In applying this observation to a substantial subset of Crockett's motive and mobility data, it was found that his conclusions regarding the role of  $n$  Ach in the transmission of status intergenerationally were essentially supported. The latter affirmation holds only when Crockett's occupational data are recoded via Census-like methods so that they can be transformed into Duncan's SES metric, and only when one accepts the kind of causal model that apparently lay behind Crockett's study design.

#### 7.4. Inferences about Motives

As we have just seen, a cross-sectional study of motives and mobility is vulnerable as a basis for estimating causal influences of motivation on occupational achievement. Even if the indicator(s) of

motivation that are obtained in such a study are highly valid measures of the current motivational state of the respondent, they may not represent at all well his level of motivation at the times when current levels of status achievement actually were attained. At present, we know very little about the persistence of motivational syndromes over time, so that a hypothesis like "motivational constancy" is even more hazardous than that of "constancy of the IQ." Moreover, there is a dearth of knowledge as to the degree to which the expressions of motivation at any given point in time may be influenced by contemporaneous situational circumstances as opposed to possibly enduring dispositions or orientations.

In working with Crockett's material, although we are entitled to suspect that motivation, as measured, is contaminated by actual level of achievement, there does not seem to be any convenient way to represent this suspicion formally in a model so as to secure estimates of the degree of contamination or its impact on other relationships. In the analysis of the FGMA data, by contrast, we were able to suggest one possible pattern of relationships among variables that illustrates some of the more salient possible sources of fallibility in measures of motivation. The work of constructing an appropriate model was more than a little arduous, and a presentation in detail is more than a little tedious. A full account is given in Report #5, and only the gist of the results is recapitulated here.

The essential features of the causal model are depicted in both of the accompanying figures, which are based on the same data and causal scheme but with different assumptions concerning reliability and validity of indicators. We assume that the FGMA variable Commitment to Work is an indicator of an underlying motivational variable "Work Orientation," as the latter had developed by the time the respondent completed school. Similarly, it is assumed that the FGMA variable Importance of Getting Ahead is an indicator of a hypothetical variable "Ambition" that came into operation at an early stage of the life cycle. The two indicators are taken to be more or less fallible measures of the respective hypothetical variables. Specifically, responses on each are assumed to be contaminated by the respondent's degree of satisfaction with his financial, occupational, and educational achievements to date, as measured by a variable Subjective Achievement, which is a composite of FGMA variables Level of Status Satisfaction and Feelings of Economic Security (Westoff et al., 1961, Appendix C). The crucial assumptions, then, are that Commitment to Work is a function of the hypothetical variable "Work Orientation" and of Subjective Achievement, but is not directly affected by any other variables in the model. Similarly, Importance of Getting Ahead is a function of "Ambition" and Subjective Achievement, but is not directly influenced by any other variables in the model. In addition, in Model 7.4.1 it is assumed that the determination of each of the indicators by the pair of explicitly represented determinants is complete; but in Model 7.4.2 a residual path of .6 is introduced, to represent random variation in the indicator not related to its systematic sources. In the latter, moreover, all correlation coefficients are corrected for

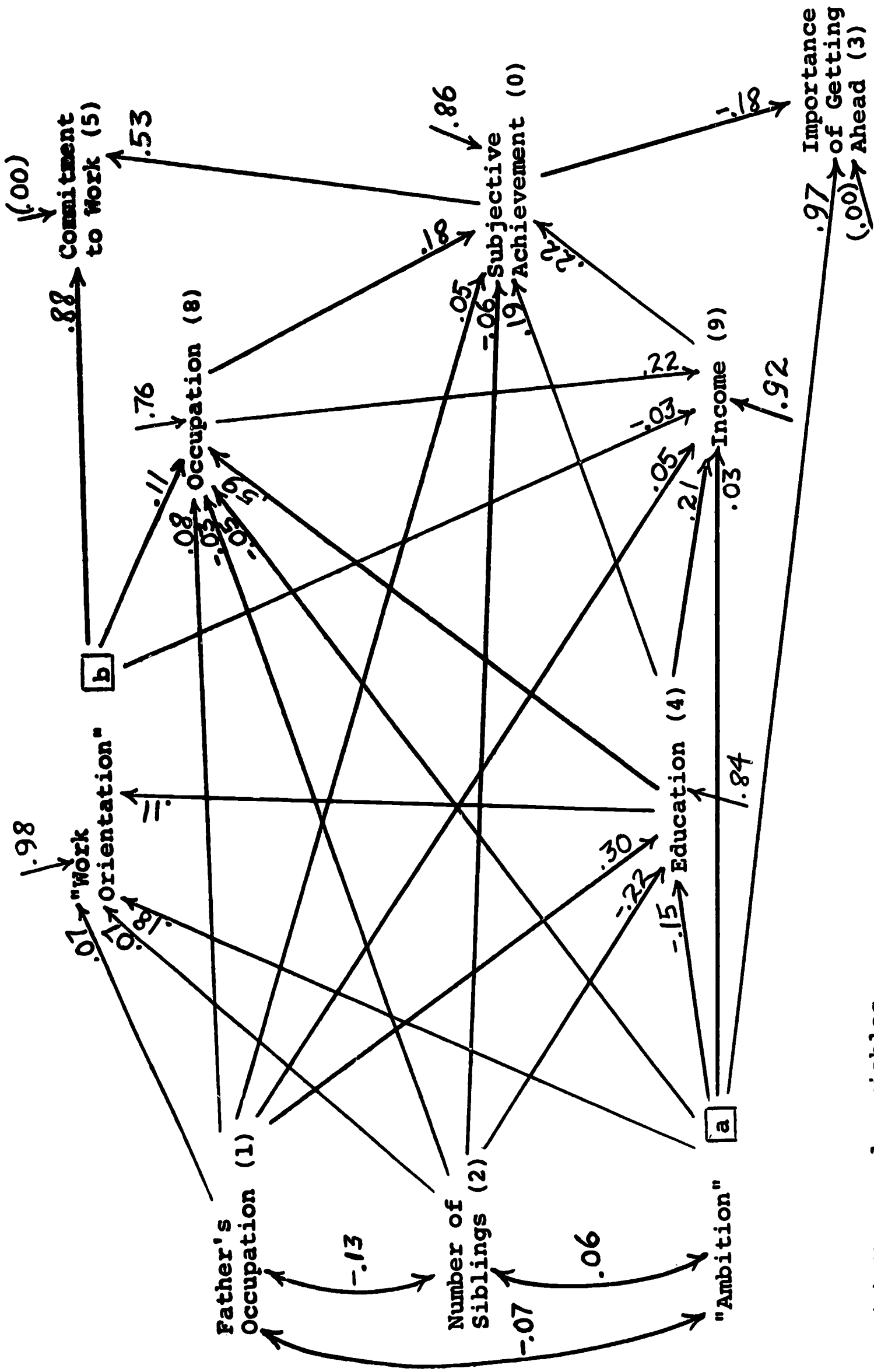

( ) Measured variables

□ Unmeasured variables

Figure 7.4.1.--Role of Two Hypothetical Motivational Variables in the Process of Achievement, on Specified Assumptions Concerning Validity of Indicators. (Estimates from FGMA data without correction for attenuation; see Report #5.)

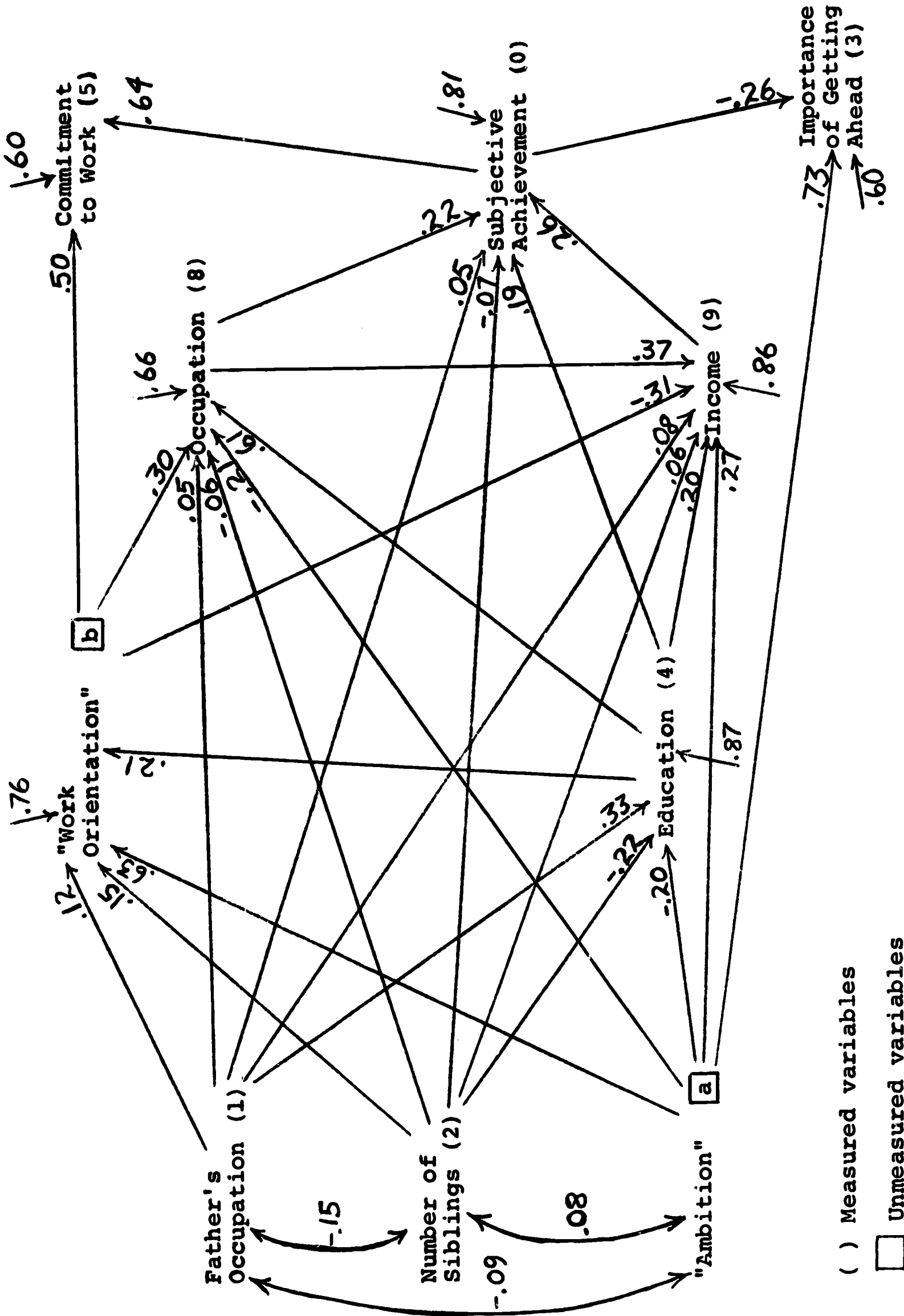

Figure 7.4.2.--Role of Two Hypothetical Motivational Variables in the Process of Achievement, on Specified Assumptions Concerning Validity of Indicators. (Estimates from FGMA data, after correcting correlations for attenuation; see Report #5.)

attenuation, due to unreliability of measurement, before commencing the calculation of estimates. Thus Figure 7.4.1 represents a situation where the indicators and other variables in the model are taken to have high validity but relatively low reliability, whereas in Figure 7.4.2 reliability is high but validity is low. The two sets of numerical estimates are, however, only illustrative of a pair of possibilities among an infinite number that might be entertained on alternative assumptions as to degree of reliability and validity. The especially instructive feature of such models is that they handle the problem of "validity" as an integral part of rendering a complete causal interpretation of the data, and not on some ad hoc basis. In the full account of the work with these data (Report #5), it is shown that allowance for either imperfect reliability or imperfect validity (particularly the latter) of indicators leads to results that are somewhat different than would be obtained on the usual assumption that all variables may be interpreted at face value.

In preparing the estimates shown here, the calculations are made on the partially reduced forms of the original models; that is, the variables occupation at marriage (6) and income at marriage (7), which were treated as intervening variables in the original version, are dropped. This simplifies the interpretation of the results without altering them in any essential way.

Although there are some very substantial differences in the estimates of parameters as between the two versions of the model, the importance qualitative aspects of the interpretation are much the same. All path coefficients shown are at least equal in size to one standard error, as best as that can be estimated. (Actually, standard errors as computed from conventional regression formulas are probably not applicable in a diagram involving unmeasured variables.)

Perhaps the most interesting result, from a heuristic standpoint, is that the two motivational variables play rather distinct roles in the model, even though they are positively correlated with each other ( $r_{ab} = .16$  in Figure 7.4.1 and  $.58$  in Figure 7.4.2). "Ambition" gives rise to a positive "Work Orientation," but "Ambition" has a negative direct influence on education while "Work Orientation" influences education positively. A positive "Work Orientation" appears to serve as a drive toward occupational achievement, while a high level of "Ambition" impedes such an achievement. On the other hand, when level of occupational achievement is taken into account, "Work Orientation" has a net depressing effect on income, while high "Ambition" raises income. As previously noted, neither motive is allowed in the model to influence directly the respondent's Subjective Achievement. Rather, the latter is regarded as a contaminator of the indicators of the motives. Thus, a high level of Subjective Achievement has a positive influence on the attitude called Commitment to Work but a negative influence on Importance of Getting Ahead. Thus, Commitment to Work serves not only as an index of the motivational force of "Work Orientation" but also reflects the way in which attitudes stemming from that motive are reinforced by

actual achievement. By contrast, Importance of Getting Ahead, while it does register in a distorted way the impact of "Ambition" on current attitudes, also reveals the extent of the respondent's dissatisfaction with achievement to date. For a person who has (in his own mind) enjoyed considerable success it is no longer so "important" to "get ahead"; but the respondent who defines his performance as unsatisfactory acknowledges that it is still "important" that he "get ahead."

If these properties of the model bear any resemblance to the real world, it seems that an undifferentiated striving for success or competitiveness is not necessarily the optimum condition for the realization of achievement in the world of work. To the degree that "Ambition" is translated into a positive evaluation of work, it serves as a spur to achievement. But to the degree that "Ambition" is directly addressed to the attainment of the rewards of achievement, such as income, it actually depresses achievement although it raises the level of monetary reward for a given degree of occupational achievement. Crudely, the "ambitious" man works hard to get a good job, but confronted with the choice he sacrifices occupational status for the "quick buck."

One overall contrast between the two sets of results, Figures 7.4.1 and 7.4.2, has to do with the general importance of motivational variables relative to other variables in the model. In the second diagram, the path coefficients for both "Ambition" and "Work Orientation" are much more substantial than in the first. The second diagram, it is recalled, records the results obtained on the assumption that the indicators of the motives are not highly valid, but rather contain substantial random elements (represented by the residual paths leading to variables 3 and 5). Thus, the model allows us to attribute a substantial importance to motivation only on the assumption that the indicators of motives are highly fallible, in the sense of contamination by random "noise" or irrelevant cues. If we reflect that measurement of motivation is nearly always indirect or inferential, it would appear that the goal of measurement must be to reduce to the minimum the influence of irrelevant cues to the end of producing indicators that are as nearly valid as possible. How this is to be accomplished is a question on which this model is practically silent, apart from the evident point that all possible care must be taken to prevent the indicator from being contaminated by the very outcomes that are supposedly a product of the motives.

#### 7.5. Aspirations as Indicators of Motivation

In section 7.2, we treated the variable "college plans" in the WISC data set as an indicator of a "latent decision" to attain higher education. Here, a similar technique is employed, but its inspiration is the somewhat different notion that "college plans" may be interpreted as "educational aspirations," and that expressed aspirations may, in

general, be thought of as reflections of an underlying motivational syndrome. To effect an interpretation on this point of view, occupational as well as educational aspirations are brought into the picture.

The seven variables selected from the WISC data set for this exercise are listed in Table 7.5.1. Some further explanation of the variables may be desired. Socioeconomic status (SES) of the respondent's family of orientation is a composite of six items from the questionnaire filled out by him. Sewell and his collaborators on the WISC project carried out a factor analysis of these items and contrived a factor-weighted score. The mechanics of this procedure are not particularly relevant here, but it may be of interest to indicate the makeup of the composite index. Some relevant information is given in Table 7.5.2. In view of the fact that in the OCG and other data sets we are limited to only two measures of family SES, father's occupation and education, it is interesting to discover that the composite SES measure in the WISC data is dominated by these two components.

The intelligence quotient (IQ) is the percentile rank on the Hermon-Nelson test used in Wisconsin schools. Educational aspirations (Ed Asp), so-called in the present discussion, refers to the respondent's statement in regard to "what do you plan to do next year?" Those not planning further schooling at that time are scored zero; scores of 1 to 4 were assigned for plans to attend schools at various levels, ranging up to university or liberal arts college. Occupational aspirations (Oc Asp) refers to the "type of occupation" the respondent "hopes eventually to enter." Broad categories are scored on an arbitrary scale roughly similar to the North-Hatt prestige scale or Duncan's socioeconomic scale. School grades were used to compute high school rank (HSR) expressed on the basis of percentiles within the respondent's class.

Educational achievement (Ed Ach) refers to the amount of schooling beyond high school attained by the respondent as of the followup survey in 1964; categories include those with no schooling beyond high school, those attending vocational schools, those with some college, those completing college, and those with some post-graduate work. Occupational achievement (Oc Ach) refers to the score on Duncan's socioeconomic scale of the occupation being pursued as of the 1964 followup.

Two models were developed to represent the interpretation that aspirations are expressions of an underlying motivational variable; the two are shown together in Figure 7.5.1. Substantively, the two models make the same basic general postulate: that expressed aspirations are reflections of an underlying orientation, which may well be a complex of several distinct motives. The difference between the two models arises from the specific assumptions that are required to translate this premise into numerical estimates of parameters. The two models will be described in turn; the basic structure of each can best be brought out by describing the derivation of equations for securing parameter estimates.

Table 7.5.1.--Intercorrelations of Selected Variables in WISC Data Set (Wisconsin Male High School Seniors, 1957, Followed Up to 1964)

Variable Name and Number	Variable Number						
	(1)	(2)	(3)	(4)	(5)	(6)	(7)
Socioeconomic status of family (1)	...	.2929	.4438	.3937	.2177	.4382	.3277
Intelligence quotient (2)		...	.4296	.4176	.5320	.4853	.3631
Educational aspiration (college plans) (3)			...	.7906	.4215	.6861	.4714
Occupational aspiration (4)				...	.4136	.6336	.4641
Grades (high school rank) (5)					...	.5046	.3458
Educational achievement (1964) (6)						...	.6207
Occupational achievement (1964) (7)							...

Source: WISC data set for 4,386 senior boys (followup sample).



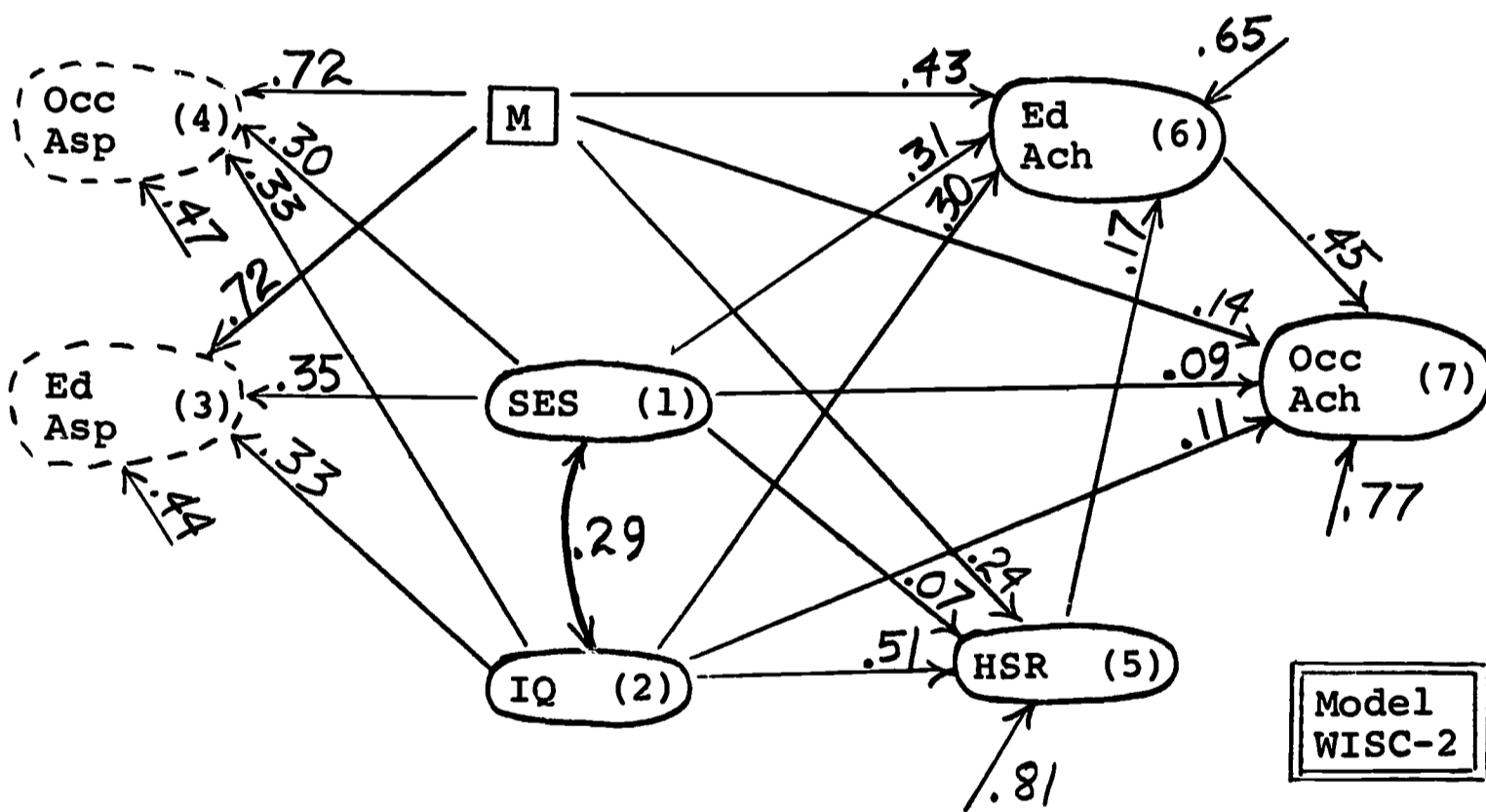
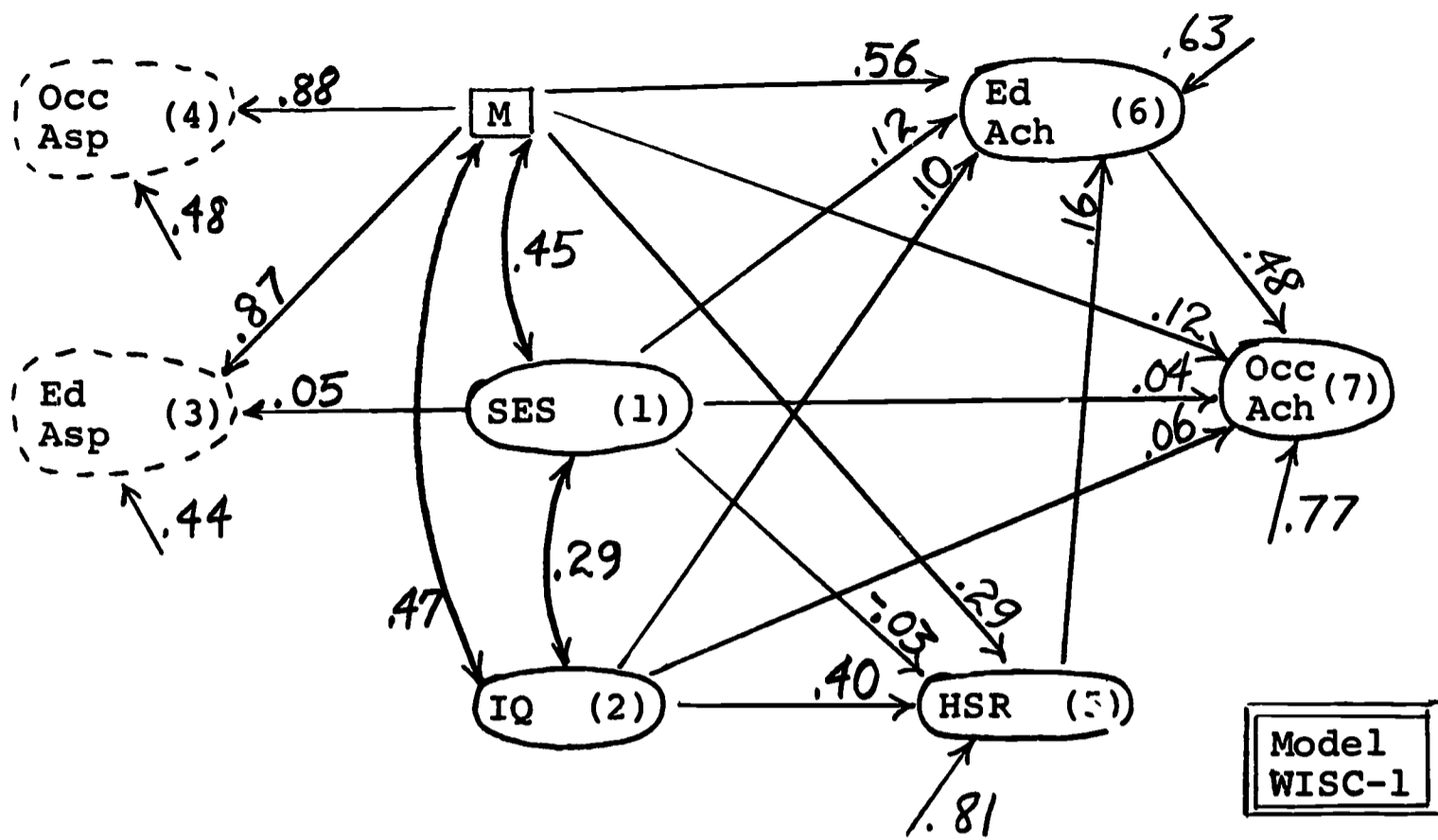

Figure 7.5.1.--Alternative Models Interpreting Aspirations as Indicators of Motivational Factor in Achievement. (Path coefficients estimated from WISC data set; see Table 7.5.1.)

Table 7.5.2.--Components of the SES Index Used in the WISC Data Set

Component	Correlation with SES	Partial Regression, Standard Form, SES on Component			
		(a)	(b)	(c)	(d)
Father's occupation	.790	.442	.554	...	.580
Father's education	.723	.295	.347	...	.457
Mother's education	.590	.210	.245	...	...
Respondent's perception of:					
Parents' ability to support college	.633	.253	...	.395	...
Amount of parental support available	.557	.195	...	.279	...
Level of family's economic status	.490	.089	...	.222	...
(Multiple correlation)	...	1.000	.913	.717	.888

Source: WISC data set for 5,004 senior boys (pre-followup sample).

Model 1 posits a hypothetical motivation variable M that is allowed to be correlated with the two observed predetermined variables, SES and IQ. Given such correlation, it is assumed that both Ed Asp and Oc Asp depend on M, that neither depends (directly) on IQ, and that only Ed Asp depends directly on SES. The last assumption is reasonable in view of the emphasis in the Ed Asp questionnaire item on definite plans, supposing that plans will somewhat reflect resources for effecting them. Variables 1, ..., 4, and M can be treated as a self-contained system without referring to the remainder of the upper diagram in Figure 7.5.1. The basic theorem of path analysis can be used to write the following equations:

$$r_{13} = p_{31} + p_{3M} r_{1M}$$

$$r_{23} = p_{31} r_{12} + p_{3M} r_{2M}$$

$$r_{14} = p_{4M} r_{1M}$$

$$r_{24} = p_{4M} r_{2M}$$

$$r_{34} = p_{3M} p_{4M} + p_{31} r_{14}$$

From the third and fourth equations,  $r_{1M} = r_{2M} r_{14} / r_{24}$ . Substitute this into the first equation and solve the first two equations simultaneously for  $p_{31}$  and the product  $(p_{3M} r_{2M})$ , obtaining

$$p_{31} = \frac{r_{13} r_{24} - r_{23} r_{14}}{r_{24} - r_{12} r_{14}}$$

and

$$p_{3M}r_{2M} = \frac{r_{24}(r_{23} - r_{12}r_{13})}{r_{24} - r_{12}r_{14}} = K_1 \text{ (say).}$$

Since  $p_{31}$  is known, we have, from the equation for  $r_{34}$ ,

$$p_{3M}p_{4M} = r_{34} - p_{31}r_{14} = K_2 \text{ (say)}$$

and from the equation for  $r_{13}$ ,

$$p_{3M}r_{1M} = r_{13} - p_{31} = K_3 \text{ (say),}$$

where  $K_1$ ,  $K_2$ , and  $K_3$  are now all known numbers. Hence we have the system,

$$p_{3M}r_{2M} = K_1$$

$$p_{3M}p_{4M} = K_2$$

$$p_{3M}r_{1M} = K_3$$

$$p_{4M}r_{1M} = r_{14}$$

$$p_{4M}r_{2M} = r_{24}$$

comprising five equations in five unknowns. The system is solved by straightforward substitutions.

Next we consider the relationships of HSR to the three predetermined variables (1, 2, and M) of the model and its correlations with the two indicators of motivation. The model postulates that HSR depends on SES, IQ, and M, and that these relations together with the correlations of the latter three variables with Ed Asp and Occ Asp account for the correlations between HSR and the two aspirations. Thus we secure four equations corresponding to the known correlations involving HSR:

$$r_{15} = p_{51} + p_{52}r_{12} + p_{5M}r_{1M}$$

$$r_{25} = p_{51}r_{12} + p_{52} + p_{5M}r_{2M}$$

$$r_{35} = p_{51}r_{13} + p_{52}r_{23} + p_{5M}r_{3M}$$

$$r_{45} = p_{51}r_{14} + p_{52}r_{24} + p_{5M}r_{4M}$$

We already have the values of  $r_{1M}$  and  $r_{2M}$ ; and the values of  $r_{3M}$  and  $r_{4M}$  are implicit in work already done, for  $r_{3M} = p_{3M} + p_{31}r_{1M}$  and  $r_{4M} = p_{4M}$ . Hence we have four equations in the three unknowns,  $p_{51}$ ,  $p_{52}$ , and  $p_{5M}$ . As a simple, heuristic device for securing a unique solution, let us add the last two equations together to obtain a set of three linear equations

in three unknowns, which are then solved by the usual straightforward routine. This procedure means that the equations do not exactly fit the values of  $r_{35}$  and  $r_{45}$ . But the fit is very close. Using the three path coefficients obtained by this procedure and the three correlations in the third equation, we obtain the implied value  $r_{35}^* = .4216$ , which compares with the actual  $r_{35} = .4215$ . Similarly, the fourth equation yields the implied value  $r_{45}^* = .41359$  as compared with the actual  $r_{45} = .4136$ . (In further calculations on the model we should, for sake of consistency, use the implied rather than the actual correlations, thought it can hardly make any difference in the results.) The close agreement indicates that the model has passed one rudimentary "test" of the suitability of its assumptions, albeit not a very conclusive test.

We now consider Ed Ach as an outcome of the process depicted by the model, assuming that it depends on HSR, IQ, SES, and M, but has only indirect linkages with the aspiration variables. It is easy to argue the case for these four influences on Ed Ach. HSR is often used as a criterion of admission to college and, moreover, may represent a pattern of scholastic work habits that should carry over more or less directly into further study. IQ presumably represents scholastic aptitude and SES, among other things, the economic means to use in pursuit of further education. Finally, the motivation variable, M, although its nature is by no means fully specified by the model, presumably summarizes such tendencies and orientations as need for achievement and persistence. The question left open by this argument is whether these relationships fully account for the correlations of Ed Ach with Ed Asp and Occ Asp. We have five known correlations of Ed Ach with prior variables and the aspiration variables.

$$\begin{aligned} r_{16} &= p_{61} + p_{62}r_{12} + p_{65}r_{15} + p_{6M}r_{1M} \\ r_{26} &= p_{61}r_{12} + p_{62} + p_{65}r_{25} + p_{6M}r_{2M} \\ r_{56} &= p_{61}r_{15} + p_{62}r_{25} + p_{65} + p_{6M}r_{5M} \\ r_{36} &= p_{61}r_{13} + p_{62}r_{23} + p_{65}r_{35}^* + p_{6M}r_{3M} \\ r_{46} &= p_{61}r_{14} + p_{62}r_{24} + p_{65}r_{45}^* + p_{6M}r_{4M} \end{aligned}$$

We note that from earlier work we may compute  $r_{5M} = p_{5M} + p_{51}r_{1M} + p_{52}r_{2M}$ , so that we have five equations in the four unknown path coefficients. As before, we reduce the number of equations by adding the last two together into one--in effect, giving them slightly less weight in the determination of the solution. Once we have that solution, we can compute the implied values  $r_{36}^* = .6687$  and  $r_{46}^* = .6510$ , which are reasonably close to the actual values  $r_{36} = .6861$  and  $r_{46} = .6336$ . Again, the model passes a modest "test."

The final step is dictated by the assumption that Occ Ach depends on Ed Ach, IQ, SES, and M for more or less obvious and plausible reasons. It is not assumed that Occ Ach depends on school grades, HSR, directly;

nor is any direct connection assumed between Occ Ach and Occ Asp or Ed Asp. After noting that the value of  $r_{6M} = p_{6M} + p_{61}r_{1M} + p_{62}r_{2M} + p_{65}r_{5M}$  is implicit in previous work, we can write six equations in four unknown path coefficients:

$$r_{17} = p_{71} + p_{72}r_{12} + p_{76}r_{16} + p_{7M}r_{1M}$$

$$r_{27} = p_{71}r_{12} + p_{72} + p_{76}r_{26} + p_{7M}r_{2M}$$

$$r_{67} = p_{71}r_{16} + p_{72}r_{26} + p_{76} + p_{7M}r_{6M}$$

$$r_{37} = p_{71}r_{13} + p_{72}r_{23} + p_{76}r_{36}^* + p_{7M}r_{3M}$$

$$r_{47} = p_{71}r_{14} + p_{72}r_{24} + p_{76}r_{46}^* + p_{7M}r_{4M}$$

$$r_{57} = p_{71}r_{15} + p_{72}r_{25} + p_{76}r_{56} + p_{7M}r_{5M}$$

We add the last three equations into a single one so that a unique solution is obtained for the four path coefficients. We may then check the implied values  $r_{37}^* = .4767$ ,  $r_{47}^* = .4632$ , and  $r_{57}^* = .3414$  against the actual values,  $r_{37} = .4714$ ,  $r_{47} = .4641$ , and  $r_{57} = .3458$ . All discrepancies are in the third decimal place, so that the final set of assumptions in the model passes its modest "test."

Comments on the numerical results with Model 1 are reserved until Model 2 has been described. In terms of the structure of relationships, the two models differ only in the assumptions used to relate the indicators, Ed Asp and Occ Asp to the hypothetical motivation variable M. In Model 2, M is assumed to be uncorrelated with IQ and SES. To see how this assumption is used, consider variables 1, ..., 5, and M as a self-contained system with reference to variables 5 and 6. Essentially, M is taken to explain such intercorrelations of HSR, Occ Asp, and Ed Asp as are not explained on the assumption that each of these variables depends on both SES and IQ. The procedure is to compute the regressions of HSR on SES and IQ, of Occ Asp on SES and IQ, and of Ed Asp on SES and IQ, thus obtaining the path coefficients  $p_{51}$ ,  $p_{52}$ ,  $p_{41}$ ,  $p_{42}$ ,  $p_{31}$ , and  $p_{32}$ . Our assumption that M is the common factor in HSR, Ed Asp, and Occ Asp which accounts for their residual intercorrelations allows us to write

$$r_{34} = p_{3M}p_{4M} + p_{31}r_{14} + p_{32}r_{24}$$

$$r_{35} = p_{3M}p_{5M} + p_{31}r_{15} + p_{32}r_{25}$$

$$r_{45} = p_{4M}p_{5M} + p_{41}r_{15} + p_{42}r_{25}$$

Since the correlations are known and we have obtained values for  $p_{31}$ ,  $p_{32}$ ,  $p_{41}$ , and  $p_{42}$ , these equations take the form,

$$P_{3M}P_{4M} = C_1$$

$$P_{3M}P_{5M} = C_2$$

$$P_{4M}P_{5M} = C_3$$

and are easily solved by straightforward substitution.

The remainder of the model generates the same two sets of equations obtained at the corresponding juncture in the work with Model 1. A different solution routine was used, however, for the sake of variety if for no other reason. Of the five equations for known correlations with Ed Ach, only the four corresponding to  $r_{16}$ ,  $r_{26}$ ,  $r_{46}$ , and  $r_{56}$  were used to solve for the unknown path coefficients. The fifth equation, therefore, supplies an implied correlation, which works out as  $r_{36}^* = .6513$ , as compared with the actual  $r_{36} = .6861$ . Thus, although Ed Asp is not assumed in the model to influence Ed Ach, and although the correlation between these two variables is not used in estimating the parameters of the model, these estimates imply a value of  $r_{36}$  that is within .035 of the actual value.

In similar fashion, in the last set of six equations are two, those for  $r_{37}$  and  $r_{47}$ , that were ignored in solving for the four path coefficients. Given the estimates of the latter, we have the implied values  $r_{37}^* = .4912$  (when the implied value,  $r_{36}^*$ , is used in the calculation) and  $r_{47}^* = .4870$ . These are to be compared with the actual values, .4714 and .4641, respectively.

As far as such "tests" may be considered relevant, there is little basis for choosing between the two models. Indeed, there is nothing in the numerical results to afford a basis for such a choice, unless one has strong preconceptions such that one set of results seems more reasonable than the other. No claim can be made, moreover, that the two models exhaust the logical possibilities with respect to models that treat aspirations as indicators of motivation.

In one respect, the models hardly differ (and this trivial difference may reflect variation in the estimation procedure as well as the structure of the models), that is, in regard to the direct determinants of occupational achievement. Corresponding paths to Occ Ach are very similar in the two models, and neither has an advantage with respect to "explained" variation. By contrast, Model 1 gives heavier weight to M as a direct influence on Ed Ach and lesser weights to IQ and SES, while HSR has about the same modest weight in both models. Evidently, the reason for this contrast is that in Model 1 M is allowed to be rather substantially intercorrelated with SES and IQ. In Model 2, on the other hand, the paths from SES to Ed Ach and IQ to Ed Ach are not affected by the inclusion of M. Hence, this model gives an immediate impression of what is gained in a formal explanatory sense by inclusion of M along with SES and IQ as predetermined variables of the model. Model 2, however, makes equally good use of this additional information, since the residual for Ed Ach is about the same as in Model 1.

The differences between the two models in regard to the paths to HSR are surprisingly small, given the ostensibly different logic on which they are obtained in the two cases. In Model 2, HSR is, in effect, itself regarded as an indicator of motivation, along with Ed Asp and Occ Asp, and the treatment of the three variables with respect to SES, IQ, and M is completely symmetrical. In Model 1, on the other hand, HSR does not come into the picture until interrelations of the two aspirations and the three predetermined variables are established. The main difference, numerically, between the two models, is that Model 2 shows IQ and SES as somewhat more important determinants of HSR than does Model 1. Indeed, in the latter there is an anomalous, though numerically negligible negative path from SES to HSR.

The two models evidently entail a somewhat different conception of how motives, intellect, and family circumstances combine to give rise to aspirations, as these may be expressed in response to direct interrogation. In Model 1, aspirations are taken to be relatively "pure" measures of motivation, but the motivation variable is intercorrelated with SES and IQ. The model does not attempt to specify how such intercorrelation arises--whether high IQ leads to high motivation, or vice versa, for example, or whether both have some common cause in the genes. Hence, it can only be stipulated that M in Model 1 must be assumed to be determinate only after any causal relationships giving rise to such correlation have done their work. In arguing for Model 2, on the other hand, one might insist that M represents an innate or congenital disposition pattern that is uninfluenced by intellectual traits or socioeconomic circumstances, but combines with the latter in producing such manifestations as aspirations and in affecting such behavioral outcomes as school grades, educational attainment, and occupational achievement. Perhaps enough has been said to suggest that there is no intention here of making a contribution to the theory of motivation. The much more modest goal of making some plausible assessment of how motivation may influence achievement is elusive enough.

A reconciliation, or at least a clarification of the differences between the two models may be facilitated by a study of their respective reduced forms, as depicted in Figures 7.5.2 and 7.5.3. This comparison, as well as the one afforded by Figure 7.5.1, makes it clear that there is no difference in overall "explanatory power" between the models to suggest a choice between them. Parenthetically, we might note that neither model represents an improvement, in this purely statistical respect, between a straight regression of variable 7 on variables 1, ..., 6 ignoring the construct, M.

In Model 1, motivation looms larger as an influence on Ed Ach and Occ Ach than in Model 2, reflecting the assumption in the former that motivation is correlated with SES and IQ. One might elect to state the matter this way: Model 2 depicts a conception of "motivation" that tends to locate it in sources independent of socioeconomic influences and intellectual ability. Perhaps M in Model 2 is simply the earlier, more nearly innate basis of what is seen as M in Model 1. In Model 1,

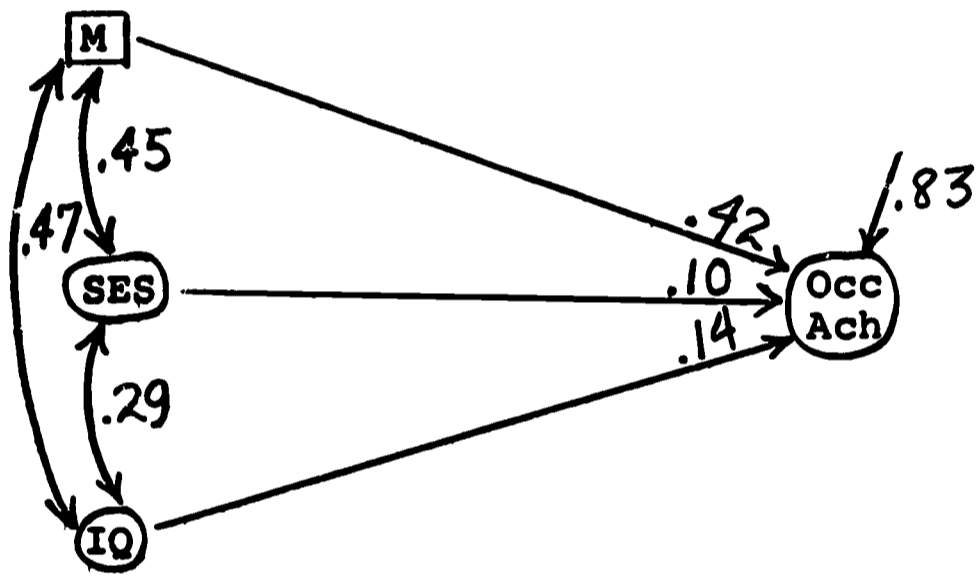
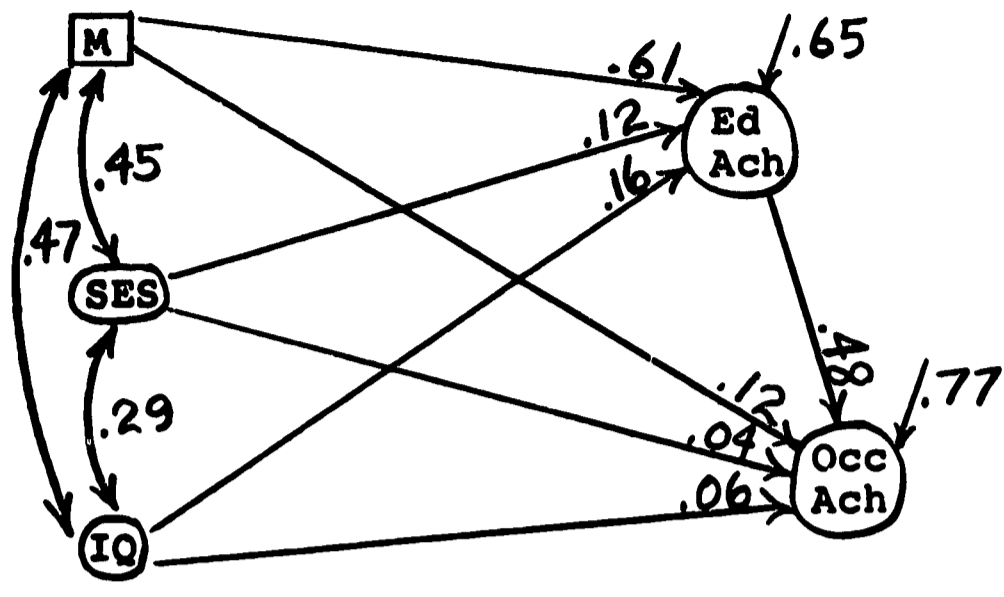

Figure 7.5.2.--Reduced forms of Model WISC-1.



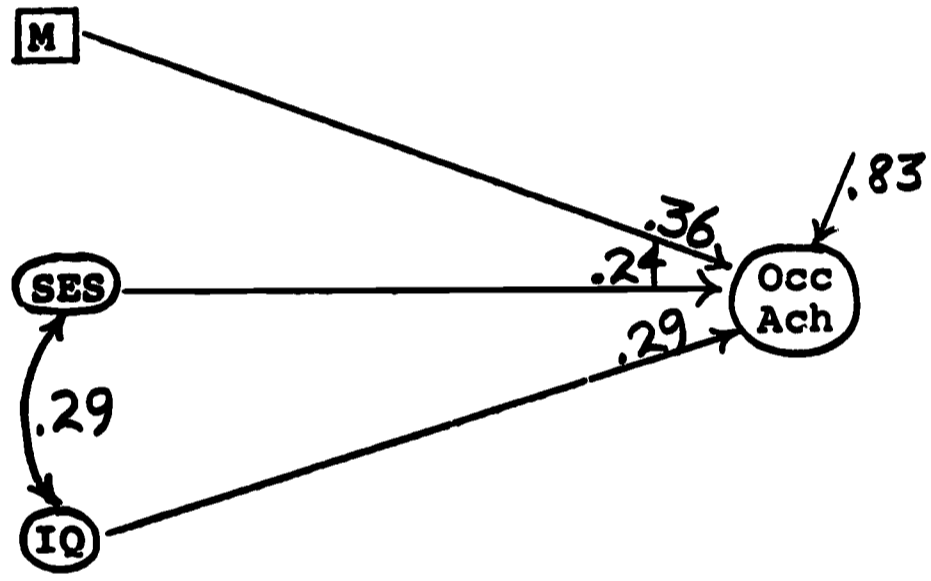
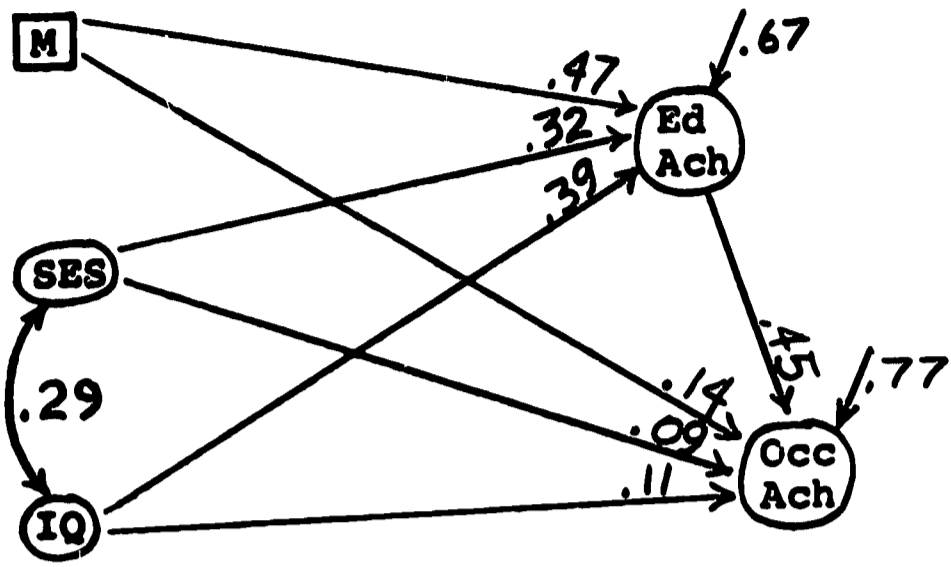

Figure 7.5.3.--Reduced Forms of Model WISC-2.

we are observing (actually, of course, constructing) the motivation variable after it has emerged from a process of organism-environment interaction that sets up correlations between M and both SES and IQ.

Suppose one held to the view that M, as it operates in Model 1, is actually a "socialized motivation" that represents the resultant of a combination of three factors: some congenital, perhaps temperamental, basis of motivation--call it M'; intelligence; and socioeconomic environment. Then we might regard M as caused by (dependent on) M', SES, and IQ. This hypothesis is represented by the upper diagram in Figure 7.5.4, in which the assumption is made that M is completely determined by the three identified factors. If we now compute the reduced form of this modified model, as in the lower diagram of Figure 7.5.4, we obtain the same coefficients for SES and IQ that we had in the reduced form of Model 2 (lower part of Figure 7.5.3). The latter, however, shows M as an influence on Occ Ach operating independently of SES and IQ. On the hypothesis just stated, this must be, in actuality, M', i.e., the postulated early or congenital basis of motivation.

Whatever the details of the argument, therefore, we reach much the same general conclusion on the basis of either model: if aspirations are conceived as indicators of motivation, then the data allow us to claim that motives play a significant role in the process of achievement, either as intervening variables transmitting the effect of socioeconomic background and intelligence, or working independently thereof, or in both ways. The data do not permit a choice among these possibilities, nor do these exhaust the possibilities that might be considered.

#### 7.6. Hypotheses about Indicators of Motivation

Theories of motivation often state reasons why direct observation of motives and straightforward reporting by the subject on his own motivational states are likely to be impracticable. Such theories, indeed, seem to have pushed to the limit of human ingenuity in contriving systems in which things are never what they appear to be. A respondent may always be suspected of being unaware of his true motives, of vouchsafing rationalizations or disguises of them, or of expressing them in ways that are not readily recognized. In some sense, motives can only be observed in terms of their consequences. But the use of motivation as an explanatory category demands--if simple circularity is to be avoided--that the particular consequences through which the motives are recognized be distinct from the particular consequences that the motives are supposed to explain. Hence in empirical research invoking motivational explanations, there is a need for indicators of motives than can be made experimentally independent of the behaviors which the motives are hypothesized to influence.

Our work in this project has not been concerned with issues of motivational theory but rather with the question of how available indicators of motivational states or complexes can be interpreted in the

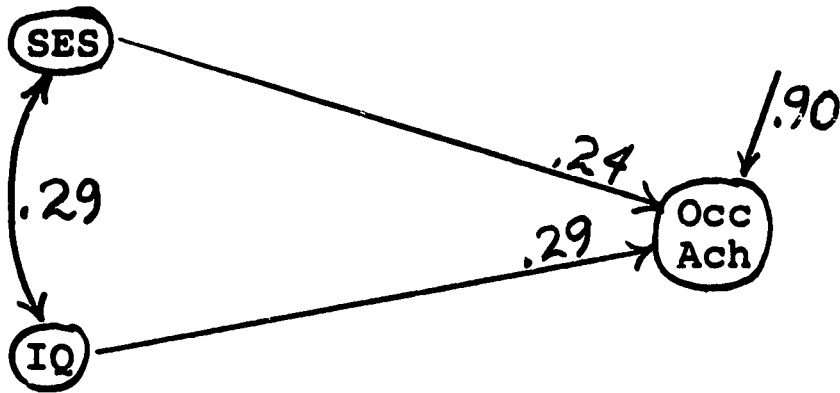
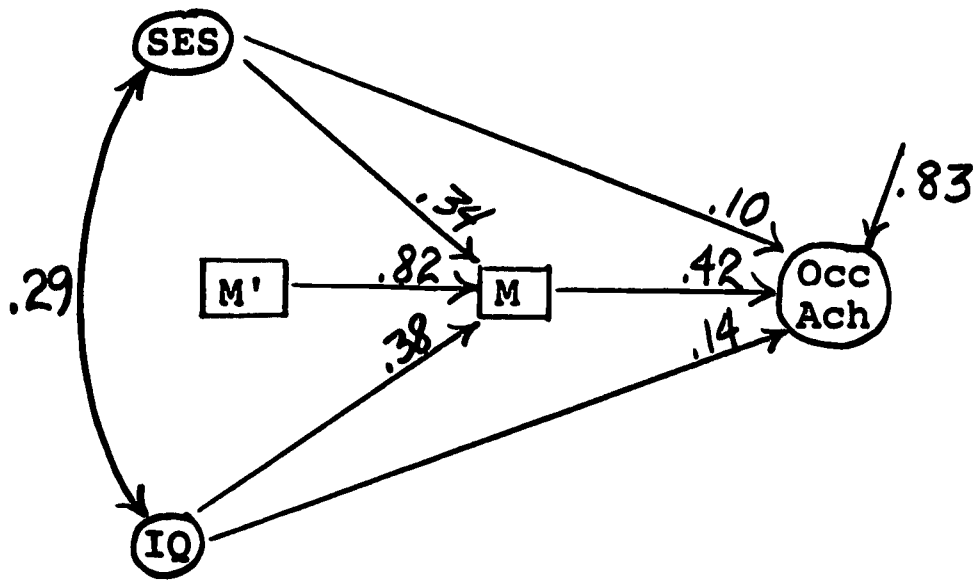

Figure 7.5.4.--Modification of Model WISC-1 to Treat M as Dependent on SES, IQ, and Earlier Motivation (M') and Reduced Form of Modified Model.

context of a model purporting to describe the process of achievement. The initial problem confronted was this. A plausible measure of achievement correlates, say, .3 or .4 with a plausible measure of socioeconomic background. If this correlation is assumed to represent the degree to which background influences achievement, the obvious question is how this influence is exerted. One kind of answer that has been given is that socialization patterns and interpersonal relations in the family of orientation give rise to fairly enduring orientations or dispositions that guide future actions and instigate, in varying degrees, efforts directed toward status achievement.

It seems evident that for data to be entirely convincing in their support of this hypothesis, certain requirements as to temporal pattern would have to be met. One would, ideally, take observations on what are believed to be the best indicators of the presumably relevant dispositions at a stage in the life cycle preceding the completion of schooling and the initiation of an occupational career. Such observations would be repeated periodically over a considerable period of years, to establish the stability of the indicators and thus, by assumption, that of the underlying dispositions. Further, the correlations of the initial measurements with both family background variables and ultimate achievement would be ascertained. Assuming the stability of the indicators, this material would lend itself to a test of the hypothesis described above: that enduring dispositions are a significant category of variables intervening between experiences in the family of orientation and the level of occupational achievement.

Even under these conditions of an idealized research design, the loophole in the test of the hypothesis is the unknown degree of validity of the observable indicators of dispositions. If the test fails, it is always possible to argue that inappropriate indicators were used, either because of inadequate concepts leading to attempts to measure the wrong kinds of motives, or because the indicators were excessively fallible, being unreliable or subject to systematic distortion. Of course, unreliability per se should have been detected in temporal instability of the indicators. High reliability and stability alone, however, do not guarantee that anything significant is being measured.

These cursory observations are intended only to supply the pretext for the exercise reported in this section, which, unhappily, does not concern data from an ideal research design but rather a much more typical situation. We have in the DAS data set, which derives from a conventional cross-sectional survey, a current measure of occupational achievement and retrospective measures of family background. The variables we shall treat as purported indicators of motives or dispositions, however, were not measured at some time clearly antecedent to the achievement of the current occupational status or the establishment of a career line leading to it. Instead, they were measured at the same time as occupational status itself. There is no information on the temporal stability of the traits measured by these indicators, and it is merely a postulate that these traits were in fact operative at the time when the

actions and decisions leading to the current occupational status were taken.

Inasmuch as this postulate cannot be tested with the data at hand, what can be learned from these data that is relevant to the problem under discussion is quite limited. We can only hope to ascertain whether the data are consistent with a possible interpretation that invokes dispositions as intervening variables. Lest we seem to disclaim too much, it should be stated for the record that studies which are presented as doing more than this are often guilty of introducing the requisite assumptions tacitly. When such assumptions are brought to light, it becomes all too apparent that they are highly arbitrary, however appealing to the intuition. Hence, the reader is not asked to endorse the assumptions made here, but merely to accompany us in tracing out their consequences. If the consequences seem plausible, we have some basis for recommending an effort to improve the justification of the assumptions. If the consequences are disappointing in some degree, the recommendation must also stipulate a redoubled effort to contrive appropriate indicators.

In the DAS data set we have measures of family background and occupational achievement much like those used throughout the project. Indeed, special pains were taken to ensure that the coding of all occupation responses was carried out according to procedures used by the Bureau of the Census, so that rather strict comparability to OCG occupational data could be assumed. In addition, the DAS interview provides a measure of intelligence, the respondent's score on the Similarities Subscale from the Wechsler Adult Intelligence Scale. This subscale is thought to have fairly high reliability when employed alone and to correlate well with the general factor measured by the whole scale. Inasmuch as this section is not primarily concerned with interpreting the role of intelligence in achievement, we have adopted the convenient and not wholly misleading assumption that the Similarities score is a predetermined variable, causally prior to the measures of achievement. Although our procedures are far from ideal, we do offer a first approximation to the request made by Kahl (1965, p. 678): "I am still waiting for a study that combines both intelligence and motivation within the context of social structure."

Three variables in the DAS interview schedule were selected for treatment as indicators of hypothetical motivational factors: (1) a measure of the degree to which the respondent's work values conform to a pattern suggested by features of the "Protestant Ethic"; (2) a measure of achievement orientation toward occupations; and (3) the respondent's subjective social class identification. Some description and comments on these are in order.

The measure of "Protestant" work values was adapted from the research of Lenski (1963). Our score was derived from responses to this series of questions:

Q. 49. Now I'd like to ask you some more questions about your own interests and ideas. Would you please look at this card, and tell me which thing on this list you would most prefer in a job.

1. High income
2. No danger of being fired
3. Short working hours, lots of free time
4. Chances for improvement
5. The work is important and gives a feeling of accomplishment

Q. 50. Which comes next?

Q. 51. Which is third most important?

Q. 52. Which is least important?

The wording of the alternatives is the same as that used by Lenski, except that in the fourth alternative the word "improvement" was used where Lenski's question read "advancement." It will be noted that the series of questions has the effect of leading the respondent to make a complete ranking of the five alternatives. To make use of all the information in this ranking, we need some assumptions about the relationship of the alternatives to the "Protestant" norm. We followed Lenski's (1963, p. 89) interpretation of the meaning of the alternatives:

Each of these, we believed, represented a separate and distinct basis for evaluating jobs and careers. The last alternative is closest to the Protestant Ethic as conceived by Weber; it stresses both the worth of the work and the personal satisfactions it can afford. The first alternative, in contrast, stresses only the extrinsic satisfactions linked with work--the paycheck. In much of the current literature on the Protestant Ethic, this, together with a desire for advancement, is conceived to be the essence of the Protestant Ethic. While it is undoubtedly futile at this late date to try to "purify" sociological usage, it may at least prove worthwhile to call attention to these two divergent conceptions of the Protestant Ethic. Of our five alternatives, the fifth best expresses the classical Weberian understanding of the term, the first the current popular understanding, while the fourth occupies the middle ground between them. A concern for chances for advancement is consistent with both the classical and current usages.

The third alternative on our list was designed to express a view completely in opposition to any conception of the Protestant Ethic. The second was designed with the same purpose, but in retrospect it seems somewhat less in conflict with the Weberian definition than it seemed at first, since it does express a desire to work.

On the basis of this discussion, we took it that the five alternatives in Q. 49 could be placed in the following rank order according to the degree to which they approach the "Protestant" norm of a structure of work values: 5-4-1-2-3; that is, the first choice would be

alternative #5 and the last choice #3. A respondent who placed the alternatives in just this order would be considered to conform perfectly to the Protestant Ethic in terms of his work values.

To score the responses to this series of questions we constructed for each respondent the implicit rank order of the five alternatives. We then computed Kendall's tau-statistic between the respondent's rank order and the standard or normative order. A value of tau of +1.0 represents a perfect agreement of the respondent with the "Protestant" norm, while a value of -1.0 represents a perfect inversion. The following distribution of respondents according to values of tau was obtained:

<u>tau</u>	<u>f</u>
1.0	102
.8	220
.6	208
.4	199
.2	119
0.0	68
-.2	38
-.4	21
-.6	15
-.8	10
-1.0	2
NA	11
Total	1013

As Lenski notes, there is a high degree of endorsement of the Protestant Ethic in the general population. Only a small minority of men present a ranking that leads to a negative value of tau. In using the value of tau as a measure of the degree to which the respondent's orientation conforms to the Protestant Ethic, therefore, we are essentially looking at the common J-curve of conformity to a general social norm, although conformity is here measured in strictly ideological terms.

The second indicator is a variable that purports to measure the respondent's achievement orientation to occupations. It is based on responses to this question:

- Q. 56. Now suppose you were starting out in life and had to choose a job (occupation) for the first time. Would you look at this list please and tell me whether you would be satisfied or dissatisfied about the prospect (idea) of entering each of these lines of work?

- |                         | <u>Satisfied</u> | <u>Dissatisfied</u> |
|-------------------------|------------------|---------------------|
| a. Clerk in a store     |                  |                     |
| b. Carpenter            |                  |                     |
| c. Lawyer               |                  |                     |
| d. Bookkeeper           |                  |                     |
| e. Construction laborer |                  |                     |

- f. Public school teacher
- g. Truck driver
- h. Garage mechanic

A rationale for interpretation of data derived in this way has been suggested by Morgan and others (1962, Appendix C). They suggest that the need for achievement is a "supposedly enduring personality trait--a disposition to strive for success." From the literature on achievement motivation, Morgan and his collaborators deduced that "An index of achievement motivation should . . . be provided by the extent to which an individual places high values on succeeding in the difficult, high prestige occupations, and low values on succeeding in the easy occupations." These investigators used a procedure resembling the one employed here; however, there are differences in the list of occupations, the phrasing of the question, and the scoring of the responses.

Our procedure was to assign to each of the eight occupations in Q. 56 its score on Duncan's socioeconomic index. Then, for each respondent, we computed the mean score of those occupations that he endorsed as "satisfactory." This mean was then treated as the score on an occupational aspiration scale for the respondent in question. It may be noted that this procedure purports to define a "differential" (as opposed to a "cumulative") scale, somewhat in the fashion of the Thurstone attitude scaling technique. In the DAS sample, the mean occupational aspiration score was 46.8, with a standard deviation of 18.9. It can be seen in Table 7.6.1 that the mean is quite comparable to the mean of current occupational status scores in this population, but substantially higher than the actual status scores of the first jobs held by DAS respondents. Some emphasis can be given to the form in which the question was worded; it called for a hypothetical orientation that the respondent would have in beginning his work career, though not for a report on what his motivational state actually was when he did commence working. The premise that this variable indexes a trait that actually was operative at the time the career was begun and that persisted throughout the subsequent period is merely a postulate or, if one prefers, a heuristic assumption.

The third indicator is based on responses to the following DAS items:

- Q. 76. There's quite a bit of talk these days about social class. If you were asked to use one of these four names for your social class, which would you say you belong in: middle class, lower class, working class, or upper class?
- Q. 77. Would you say you are in the average part of the \_\_\_\_\_ [class named in Q. 76] or in the upper part?

The following scheme was used to assign scores on the basis of these two questions:



1. Lower class
2. Working class
3. Upper working class
4. Middle class
5. Upper middle class
6. Upper class

The mean of 3.43 (standard deviation 1.16) indicates that both "working class" and "middle class" identifications were chosen by large numbers of respondents.

The question on class identification used in DAS resembles the one proposed by the psychologist Richard Centers (1949). In Centers' work the responses are taken to indicate the "class consciousness" that emerges from the interplay of economic self-interest and the forces of economic circumstances encountered by the individual. Limitations of this point of view were suggested by Hodge and Treiman (1968), who pointed out that class identification correlates with the socioeconomic status of friends, neighbors, and relatives, independently of the respondent's own education, occupation, and income.

Neither Centers' early work nor the more recent investigations include a consideration of the possibility suggested here: that "class identification" is really, in part, a projective question that taps the respondent's desires or inclinations as well as (if not instead of) his estimate of his objective standing in society. With the DAS data we cannot, of course, put these alternative interpretations to any kind of rigorous test; but we propose to show that data on class identification are not inconsistent with the assumption that this question, like those on work values and occupational aspirations, is an indicator of underlying motivational factors that may play a role as intervening variables in the process of achievement.

The intercorrelations of the DAS variables selected for analysis here are shown in Table 7.6.1. The interpretation of these correlations that we wish to develop -- and, in only a very limited sense, to test -- can be summarized in a series of propositions. (1) Status achievement depends on family background and intelligence, with educational attainment occurring in the causal sequence prior to the achievement of current occupational status. (2) Hypothetical motivational factors intervene between the predetermined variables (intelligence and socioeconomic level of the family of orientation) and measures of achieved status. (3) These motivational factors are reflected, but only imperfectly so, in the indicators that have been identified above. One of the indicators reflects only the first hypothetical factor, F; another reflects only the second hypothetical factor, G; and the third indicator, social class, reflects both factors. In addition, social class is directly affected by the respondent's current educational and occupational levels, since these enter into his response as realistic though not rigid constraints on his expression of aspirations via the question on class identification. (4) In a causal model that appropriately represents the

Table 7.6.1.--Correlation Matrix for Selected Variables in DAS Data Set  
 [Entry below diagonal is the number of cases on which the corresponding correlation is based]

Variable*	Variable*									Mean**	S.D.**
	1	2	3	4	5	6	7	8	9		
1. Prot. ethic	...	.11	.198	.250	.191	.236	.224	.140	.169	.47	.39
2. Occ. asp.	964	...	.316	.337	.290	.373	.265	.176	.128	46.7	19.0
3. Social class	990	963	...	.479	.384	.463	.325	.271	.235	3.43	1.16
4. R's occup.	991	962	989	...	.540	.599	.435	.306	.271	45.8	24.0
5. R's first job	972	944	972	978	...	.579	.358	.299	.288	33.7	22.7
6. R's educ.	998	969	997	999	981	...	.561	.338	.322	5.04	1.58
7. R's intel.	1000	971	998	999	980	1006	...	.283	.250	13.9	5.4
8. Fa's occup.	988	959	987	987	969	995	996	...	.481	33.9	23.8
9. Fa's educ.	953	927	955	952	939	960	961	953	...	3.38	1.83

\*1. Tau measure of conformity of responses to questions 49-52 to order implied by "Protestant" orientation to work.

2. Occupational aspiration scale.

3. Subjective social class identification.

4. Respondent's current (1966) occupation scored on Duncan socioeconomic index.

5. Respondent's "first full time job after you finished school (if military service, . . . what first job after that)"; scored on Duncan socioeconomic index.

6. Years of school completed by respondent, transformed scale, with score of 2 for 0-8 grades, 4 for 9-11 grades, 5 for 12 grades, 6 for some college, 7 for college graduate, 8 for one or more years of graduate training.

7. Score on Similarities subtest of Wechsler test of adult intelligence.

8. Father's occupation, scored on Duncan socioeconomic index.

9. Years of school completed by father, transformed scale as in variable 6.

\*\*Based on largest number of respondents represented in entries below diagonal.

interrelationships of these variables, inclusion of the hypothetical motivational factors will result in essentially zero path coefficients from background variables to current occupational status. That is, the motivational factors will serve as intervening variables in such a way that the correlation between occupational achievement and socioeconomic level of the family of orientation is fully "explained." (5) The hypothetical motivational factors are not assumed to be orthogonal to each other; indeed, it is assumed that each may influence the development of the other as both are crystallized in the context of the family of orientation and affected by the individual's cognitive capacity.

The model represented by Figure 7.6.1 is one whose properties conform to the foregoing propositions. If estimates of the coefficients in this model can be derived in a consistent way, and if these estimates cannot be rejected prima facie or on the basis of other evidence, then we shall have shown that the DAS data are consistent with the interpretation sketched in the five propositions. This is, of course, a quite different thing from showing that the data confirm the propositions, an impossible task. It is unquestionably true that the same data can be shown to be consistent with an indefinitely large number of other interpretations, departing more or less drastically from the assumptions adopted here. We are really in no different situation in this exercise than in any other interpretation of a single body of data; if the present interpretation seems strained, that may only be because it is not a familiar one.

Let us proceed to a study of the properties of the model and techniques for estimating its coefficients. It is useful to break the task into two parts. First, we shall employ the assumptions about the indicator variables to derive some correlations involving the hypothetical factors, since such correlations, of course, are not given initially. Then, we shall use the derived correlations to estimate the coefficients in that part of the model that does not involve the indicator variables.

In conformity with our assumptions, variable 1 (Protestant Ethic) depends directly only on factor F; variable 2 (occupational aspiration) depends directly only on factor G; variable 3 (social class) depends on both factors F and G and also on variables 4 and 6, the respondent's current occupational status and educational attainment. If for the moment we are interested in obtaining only the path coefficients for these three variables and the correlations of F and G with the remaining variables, it is helpful to make use of the simplified model shown as Figure 7.6.2. The latter makes no assumptions concerning direction of influences among variables F, G, 4, 5, ..., 9; indeed, such assumptions are not relevant to the estimation of paths to variables 1, 2, and 3. As Figure 7.6.2 indicates, our immediate task is to estimate one path coefficient leading to variable 1, one leading to variable 2, the four leading to variable 3, the correlation between factors F and G and the six correlations of each of them with variables 4, ..., 9. This is a total of 19 unknowns (not counting the residuals for variables 1, 2, and 3, which can be estimated with the aid of the three equations of

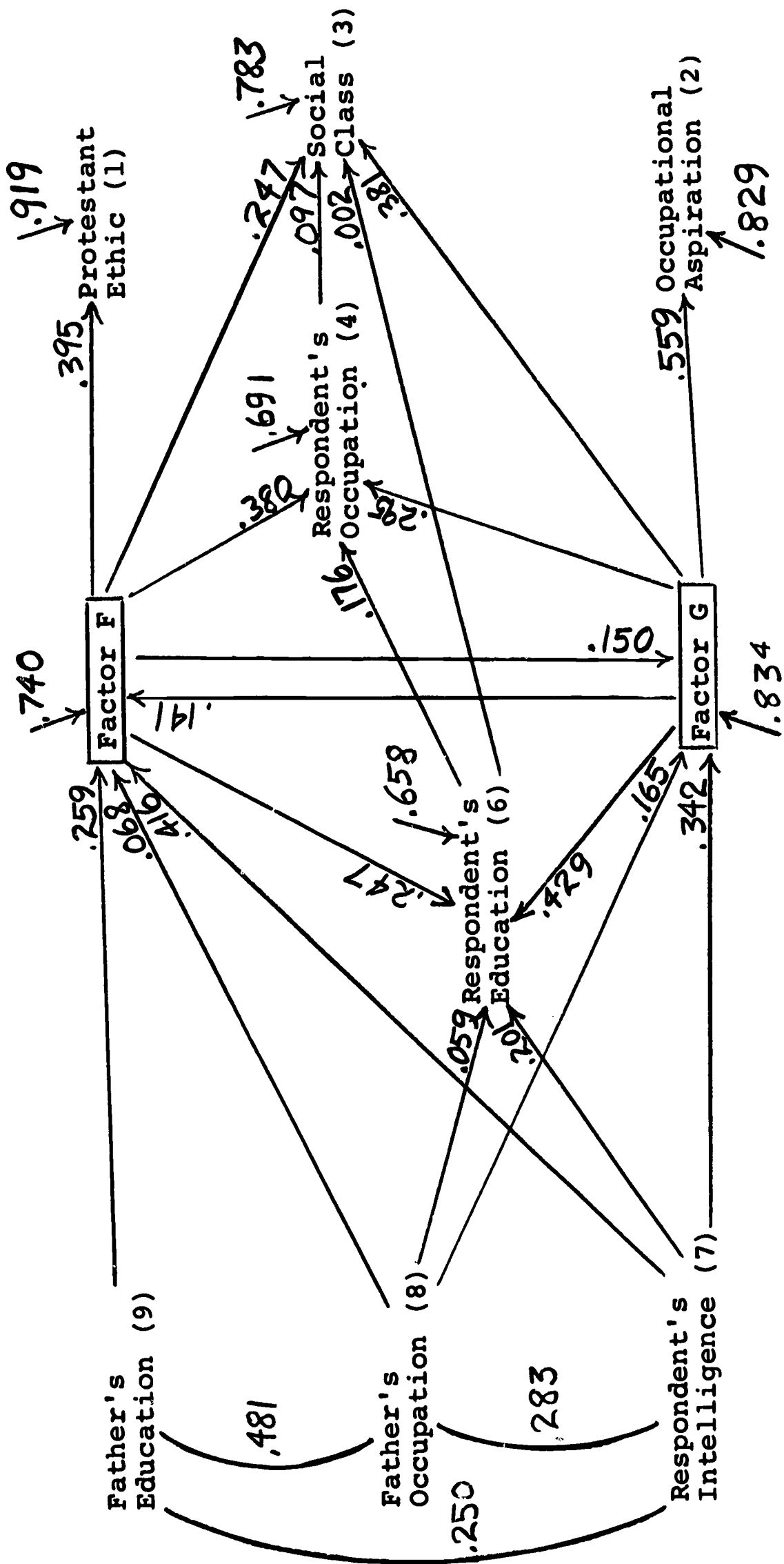

Figure 7.6.1--Hypothetical Factors, F and G, Indicated by Three Observed Variables and Interpreted as Intervening Variables in the Process of Achievement, with Path Coefficients Estimated for DAS Data Set.

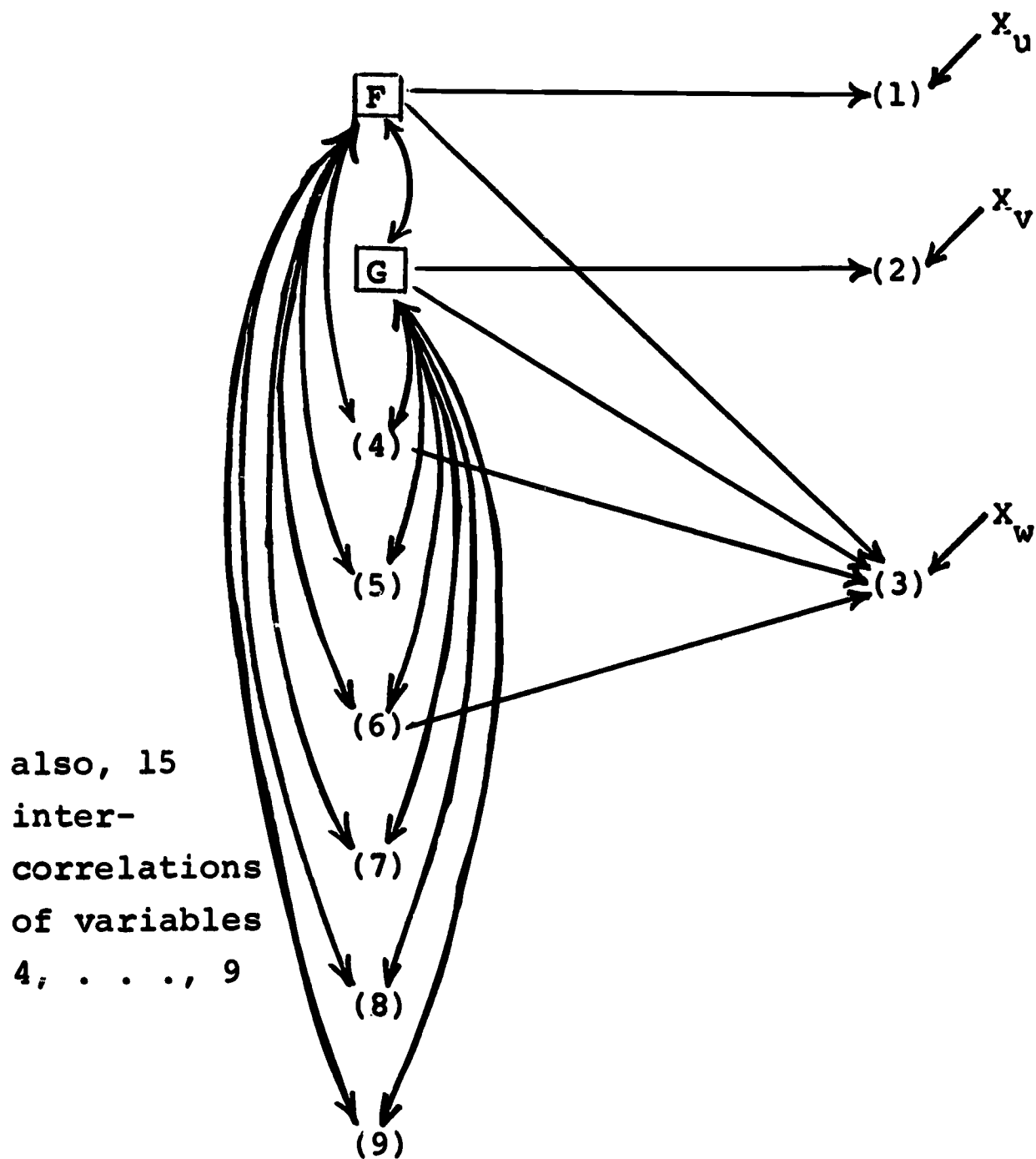

Figure 7.6.2.--Simplification of Figure 7.6.1 for Use in Estimating Path Coefficients for Indicator Variables and Correlations Involving Hypothetical Factors F and G.

complete determination, once the remaining path coefficients are known). Since there are 9 observed variables, we know 36 correlations. Of these, 15 are merely the intercorrelations among variables 4, ..., 9, and do not lead to equations that can be used in estimating other unknowns. Hence, there are left 21 known correlations that represent conditions to be satisfied by the 19 unknown path coefficients and correlations. It may be noted that Figure 7.6.2 includes variable 5, respondent's first job; correlations involving this variable are used in estimating the unknown correlations and coefficients involving hypothetical factors F and G, although this variable is not included in the final model, Figure 7.6.1, in view of the difficulties in its interpretation brought to light by the discussion in sections 9.1 and 9.2.

The three equations of the model represented by Figure 7.6.2 are as follows:

$$\begin{aligned} X_1 &= p_{1F}F + p_{1u}X_u \\ X_2 &= p_{2G}G + p_{2v}X_v \\ X_3 &= p_{3F}F + p_{3G}G + p_{34}X_4 + p_{36}X_6 + p_{3w}X_w, \end{aligned}$$

where  $X_u$ ,  $X_v$ , and  $X_w$  are residuals assumed to be uncorrelated with each other and with all the predetermined variables (i.e., F, G, and  $X_4, \dots, X_9$ ) of the model.

Suppose each of these equations is multiplied through by  $X_4$ ; we obtain

$$\begin{aligned} r_{14} &= p_{1F}r_{4F} \\ r_{24} &= p_{2G}r_{4G} \\ r_{34} &= p_{3F}r_{4F} + p_{3G}r_{4G} + p_{34} + p_{36}r_{46}. \end{aligned}$$

But, in virtue of the first two of these equations, the third can be written,

$$r_{34} = (p_{3F}/p_{1F})r_{14} + (p_{3G}/p_{2G})r_{24} + p_{34} + p_{36}r_{46}.$$

Moreover, we can similarly obtain five other equations of the same form corresponding respectively to  $r_{35}$ ,  $r_{36}$ ,  $r_{37}$ ,  $r_{38}$ , and  $r_{39}$ . Thus, we obtain a total of 6 equations in 4 unknowns, regarding (for the moment)  $p_{3F}/p_{1F}$  and  $p_{3G}/p_{2G}$  each as one unknown, the other two being, of course,  $p_{34}$  and  $p_{36}$ . We shall choose values of these four unknowns such that the sum of squares

$$\sum_i (r_{3i} - r'_{3i})^2$$

is a minimum, where  $i = 4, \dots, 9$  and  $r'_{3i}$  is the value of  $r_{3i}$  implied by the appropriate equation, given our estimate of the coefficients

appearing in it. Table 7.6.2 presents a comparison of the implied correlations  $r_{31}^i$  with the observed correlations  $r_{31}$ . The agreement is not perfect; one might well wish to entertain the hypothesis that another one or two of the predetermined variables have a direct influence on social class identification. However, the agreement seems close enough for us to proceed without revising the model, given the heuristic use we are making of it.

Table 7.6.2.--Correlations of Hypothetical Variables with Observed Variables in DAS Data Set; and Correlations of Social Class with Other Observed Variables Implied by Model in Figure 7.6.1

Variable*	Hypothetical Variable		Correlation with Social Class (3)	
	F	G	Implied	Actual
1. Prot. ethic	.3952	.1985	(.198)	.198
2. Occ. asp.	.2809	.5591	(.316)	.316
3. Social class	.5010	.5651	...	...
4. R's occup.	.6326	.6027	.4842	.479
5. R's first job	.4833	.5186	.3706	.384
6. R's educ.	.5972	.6671	.4619	.463
7. R's intel.	.5668	.4739	.3640	.325
8. Fa's occup.	.3543	.3148	.2378	.271
9. Fa's educ.	.4276	.2289	.2198	.235
F	...	.5023	...	...

\*See Table 7.6.1 for full identification.

We may now write the three equations for the intercorrelations of the dependent variables of the model:

$$r_{12} = p_{1F}r_{FG}p_{2G}$$

$$r_{13} = p_{1F}(p_{3F} + p_{3G}r_{FG} + p_{34}r_{4F} + p_{36}r_{6F})$$

$$r_{23} = p_{2G}(p_{3F}r_{FG} + p_{3G} + p_{34}r_{4G} + p_{36}r_{6G})$$

At this stage of our work we already have values of  $p_{34}$  and  $p_{36}$ . Moreover, we know that, for example,  $p_{1F}r_{4F} = r_{14}$ . Finally, we have already obtained a numerical value for  $p_{3F}/p_{1F}$  and one for  $p_{3G}/p_{2G}$ , so that  $p_{3F}$  and  $p_{3G}$  can be eliminated from the second and third equations, which

yield, after appropriate substitutions, numerical values for  $p_{1F}^2$  and  $p_{2G}^2$ . Solving for these two path coefficients allows us to obtain immediately  $r_{4F} = r_{14}/p_{1F}$ ,  $r_{4G} = r_{24}/p_{2G}$  and so on. Finally, we obtain  $r_{FG} = r_{12}/p_{1F}p_{2G}$ . The estimates obtained via the sequence of steps just sketched are displayed in the first two columns of Table 7.6.2. These may be thought of as two additional columns for the correlation matrix in Table 7.6.1. This enlarged matrix, omitting variable 5 for the reason already indicated, is the basis for all further work.

We observe at once that the correlations of occupational status with the hypothetical variables ( $r_{4F} = .6326$  and  $r_{4G} = .6027$ ) are higher than any of the observed correlations with variable 4. The interpretation we are entertaining clearly implies that the hypothetical factors have substantial influence on occupational achievement.

The next stage of our work is accomplished by ignoring variables 1, 2, and 3 and treating the remainder of Figure 7.6.1 solely from the standpoint of two dependent variables, 4 (occupational status) and 6 (educational attainment). We consider the hypothesis that occupational status depends on all prior variables, including the two hypothetical factors, while education depends on the five variables assumed to be prior to it. This leads to the calculation of the two regressions,  $X_4$  on  $X_6, G, F, X_7, X_8,$  and  $X_9$ ; and  $X_6$  on  $G, F, X_7, X_8,$  and  $X_9$ . The results of these calculations are shown in Table 7.6.3.

Table 7.6.3.--Partial Regression Coefficients in Standard Form for Regressions of Occupational Status and Educational Attainment on Prior Variables in the Model Shown in Figure 7.6.1

Explanatory Variable*	Dependent Variable			
	Educational attainment (6)		Occupational status (4)	
R's educ. (6)	...	...	.185	.176
G	.432	.429	.293	.295
F	.228	.247	.396	.380
R's intel. (7)	.202	.201	-.034**	...
Fa's occup. (8)	.036**	.059	.037**	...
Fa's educ. (9)	.058	...	-.034**	...
(Coefficient of determination)	(.569)	(.566)	(.525)	(.523)

\*See Table 7.6.1 for full identification.

\*\*Absolute value of coefficient greater than one standard error but less than two standard errors.



The striking result for occupational status is that the direct influence of both intelligence and family socioeconomic level can be neglected in a model which includes educational attainment and the hypothetical factors. That is, these three serve as intervening variables entirely adequate to explain the influence of intelligence and socioeconomic background on occupational achievement. The six-variable regression accounts for 52.5 per cent of the variation in occupational status, but the three coefficients for intelligence and socioeconomic background are individually of doubtful significance. The three-variable regression omitting them accounts for 52.3 per cent. In summarizing the results in Figure 7.6.1, therefore, only three paths leading to occupational status are shown.

Similarly, when educational attainment is the dependent variable, only three explanatory variables--intelligence and the two hypothetical factors--are substantial and clearly significant. It does, however, seem prudent to acknowledge some slight direct effect of family background, and this is accomplished for summary purposes by showing a path from father's occupation to educational attainment.

The results just reported do not depend on the nature of the assumptions made about how the associations among variables G, F, 7, 8, and 9 are generated. It is of some interest, however, to consider the problem of interpreting these associations. Two alternative interpretations are compared in Figure 7.6.3. The top diagram in that figure is simply extracted from the larger diagram in Figure 7.6.1, and we can consider this as a self-contained system for the purpose of deriving estimated path coefficients from the correlations in Tables 7.6.1 and 7.6.2. The lower diagram is similarly self-contained. If it should be accepted as the preferable interpretation, one could simply insert it into the appropriate position in Figure 7.6.1, leaving the rest of that model intact.

The lower diagram permits quite straightforward estimation. We simply compute the regression of F on 7, 8, and 9 and likewise that of G on 7, 8, and 9. The correlation between the residuals of F and G can then be secured from these results; it is mathematically equivalent to the third-order partial correlation,  $r_{FG.789}$ . The results suggest that variable 9 (father's education) has a negligible direct influence on factor G, a finding we can take into account in considering the appropriateness of the other model. Since  $r_{FG} = .5023$  (Table 7.6.2), it appears that the two hypothetical factors are not only dependent to a degree upon the same background factors, but also are associated each with the other for some other reason. The partial correlation of .286 indicates the existence of such an association, but suggests no particular mechanism that might explain it.

The alternative model (top diagram in Figure 7.6.3) includes precisely such a mechanism. The assumption here is that there are reciprocal effects of each hypothetical factor on the other. The model is one of simultaneous or joint dependence of the two factors, F and G,

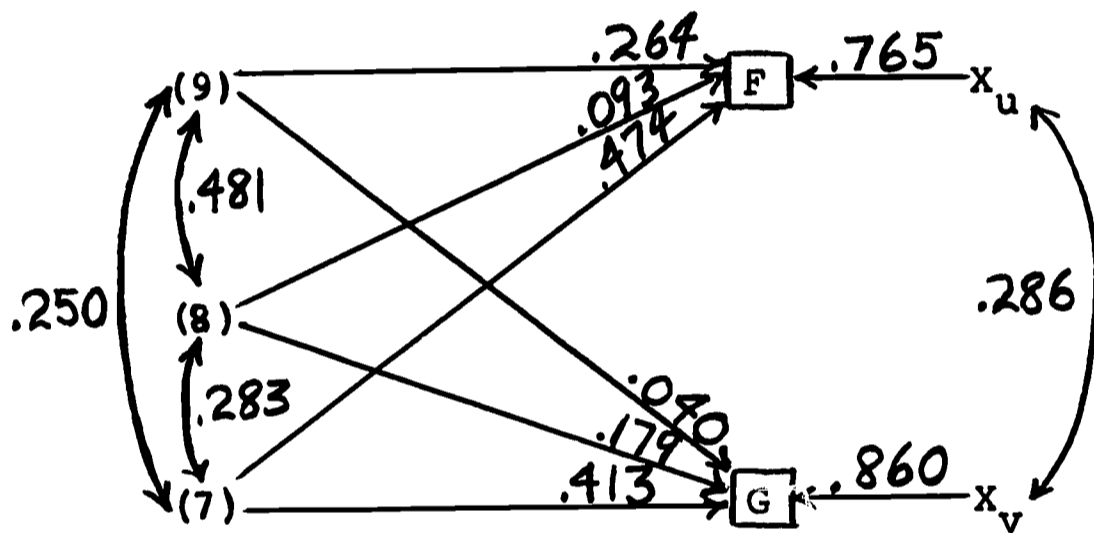
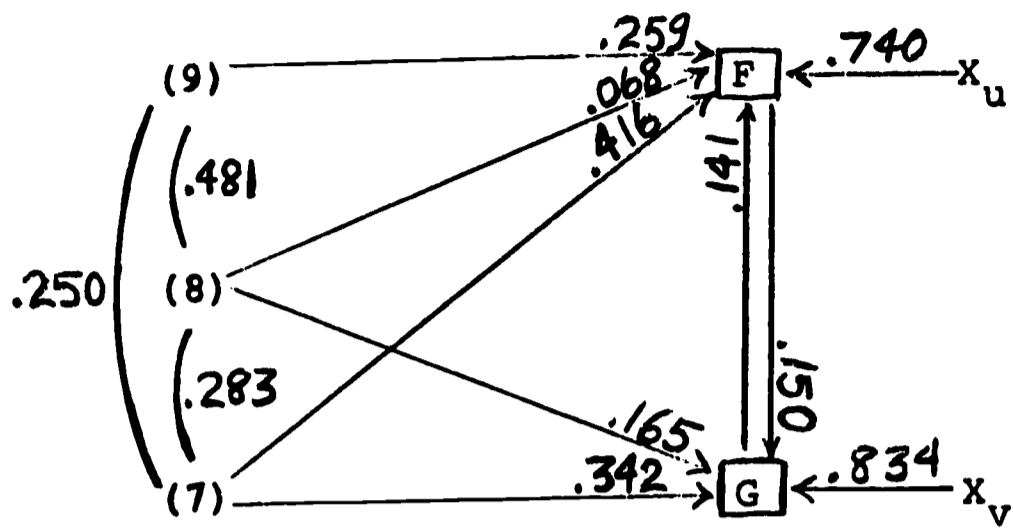

Figure 7.6.3.--Alternative Interpretations of Relationship of Hypothetical Factors to Background Variables.

a property represented by the fact that arrows run in both directions to connect the two. The equations of the model represented by this diagram are

$$G = p_{GF}F + p_{G7}X_7 + p_{G8}X_8 + p_{Gv}X_v$$

$$F = p_{FG}G + p_{F7}X_7 + p_{F8}X_8 + p_{F9}X_9 + p_{Fu}X_u ,$$

Where  $X_v$  and  $X_u$  are the respective disturbance terms, each taken to be uncorrelated with the predetermined variables  $X_7$ ,  $X_8$ , and  $X_9$ . In this case we also assume that the two disturbances are uncorrelated, so that  $r_{uv} = 0$ ; but, of course, none of the correlations of disturbances with dependent variables ( $r_{Fu}$ ,  $r_{Fv}$ ,  $r_{Gu}$ ,  $r_{Gv}$ ) is zero. This assumption is necessary for the second equation to be identified. The first equation is just-identified as it stands. We give a sketch of the estimation routine; the interested reader can work out the details.

Multiply the first equation of the model through, in turn, by  $X_7$ ,  $X_8$ , and  $X_9$ . This yields equations for  $r_{7G}$ ,  $r_{8G}$ , and  $r_{9G}$  containing the three unknown path coefficients,  $p_{GF}$ ,  $p_{G7}$ , and  $p_{G8}$ . Although the three equations do not have the symmetry of the usual normal equations for multiple regression, they are readily solved.

Next, multiply the first equation through by  $F$  and  $G$ , obtaining

$$r_{GG} = 1 = p_{GF}r_{FG} + p_{G7}r_{G7} + p_{G8}r_{G8} + p_{Gv}r_{Gv}$$

$$r_{GF} = p_{GF} + p_{G7}r_{F7} + p_{G8}r_{F8} + p_{Gv}r_{Fv}$$

In view of the solutions already obtained and the correlations that are known, these yield expressions of the form

$$p_{Gv}r_{Gv} = k_1$$

$$p_{Gv}r_{Fv} = k_2 ,$$

where  $k_1$  and  $k_2$  are known values. Now, multiply the first equation through by  $X_v$ , to obtain

$$r_{Gv} = p_{GF}r_{Fv} + p_{Gv} ,$$

since  $r_{7v} = r_{8v} = 0$  and  $r_{vv} = 1$ . If the expression just obtained is multiplied by  $p_{Gv}$  and rearranged, we have

$$p_{Gv}^2 = p_{Gv}r_{Gv} - p_{GF}p_{Gv}r_{Fv}$$

$$= k_1 - p_{GF}k_2$$

and  $p_{GF}$  is already known. Hence  $p_{Gv}$  is readily obtained. We now

multiply the second equation of the model through by  $X_v$ , to obtain

$$r_{Fv} = p_{FG} r_{Gv} ,$$

bearing in mind that  $r_{uv} = 0$ , the assumption upon which, as we said, identification depends. Hence, we readily obtain  $p_{FG} = r_{Fv} / r_{Gv}$ .

Of the four coefficients for explanatory variables in the equation for F, we now have an estimate for one. Hence correlations of F with the three predetermined variables,  $X_7$ ,  $X_8$ , and  $X_9$  suffice to estimate the remaining paths using procedures parallel to those already described.

It is perhaps largely a matter of taste which of the two models in Figure 7.6.3 we choose to accept. They are in fairly close agreement with respect to the degrees of influence that intelligence and family socioeconomic background have on the genesis of the hypothetical factors. The second model simply points out that such influence is not sufficient to explain the intercorrelation of the two hypothetical factors, while the first suggests a mechanism by which part of that correlation might arise. If we choose to think of F and G as distinct motivational complexes, each somewhat composite in nature, then perhaps it is not unreasonable to insist, not only that there is no reason for them to be orthogonal, but also that the development and crystallization of each might well have depended on the genesis of the other in some degree. This is what the top diagram in Figure 7.6.3 is intended to convey.

Let us now return to the full model as shown in Figure 7.6.1, having explored the consequences of our assumptions with regard to each of the submodels that, implicitly, comprise it. Various comments about the results are in order.

First, unless by simple inspection of the coefficients one can decide that they are unacceptable, our success in securing at least conceivable values for them shows that the model cannot be rejected on the basis of the present set of data alone. The interpretation offered is, at worst, a possible one. This assertion may not seem to have a great deal of content; but it is relevant that a great many alternative models were considered that did turn out to yield impossible or manifestly implausible results. The strategy of model construction followed in this work allows one to reject a great many incipient "theories" that suggest themselves as interpretations of the data, although it is seldom or never possible to reject all competing theories but one.

The model assigns considerable importance to the hypothetical factors, which operate both as intervening variables with respect to the three predetermined variables in the model and as sources of variation in achievement not correlated with those variables. A theorist who wishes to insist that motivation is a major factor in achievement could take these results as support for his theory. He would, however, be committed thereby to the defense of some propositions he might not find

entirely plausible. To begin with, the theorist would have to argue that F and G are indeed motivational in character. The basis for this interpretation is the prior assumption that the Protestant Ethic measure, the occupational aspiration score, and social class identification are really reflections of underlying and long-persisting motivational complexes. The defense of this assumption might not be easy. We lack direct evidence of the temporal stability of these variables. They may as well be results of achievement as indicators of the factors producing achievement, although in the case of social class this possibility is called into question by the low values of  $p_{34}$  and  $p_{36}$ . They may respond more to ideological and situational factors than to actual motivational states of the personality.

One thing is clear: if the three indicators are interpreted as such, there must be a concurrent admission that their validity as indicators is very poor. Protestant Ethic correlates only .395 with F and occupational aspiration only .559 with G, while social class correlates .501 and .565 with F and G respectively. With data on the three indicators we could not make very reliable estimates of F and G for individuals. The coefficients of determination are  $R^2_{F(123)} = .355$  and  $R^2_{G(123)} = .485$ .

Another feature of the results is somewhat disturbing, if only because it entails an unfamiliar interpretation. It is noted that both F and G depend substantially on intelligence. Each of them, in turn, outweighs intelligence in importance as a determinant of educational attainment; and while both F and G are major direct influences on occupational status, the direct influence of intelligence is virtually nil, although its indirect influence is, of course, considerable. Hence, F and G evidently operate to sum up a good deal of what we usually think of as the influence of intelligence in the process of achievement.

To summarize, our search must be considered to end in disappointment if the initial hope was that we could ascertain with high reliability and validity some indicators of motivation that take on a powerful role in explaining how achievement comes to be related to background. The disappointment is tempered by the realization that our results leave open the distinct possibility that such indicators may yet be found, given sufficient insight, ingenuity, and persistence in the search.

## CHAPTER 8

### INTERVENING VARIABLES, III: SOCIAL INFLUENCES

The concept of "social influences" in this chapter is that of other individuals or groups who may have an impact on a given individual's socioeconomic achievement. Parents, neighbors, friends, teachers, classmates, and spouses are some of the categories of significant others whose influence is often perceived by individuals themselves or alleged by observers. What form the influence may take is itself problematic: it may issue from direct interaction between the individual and the other(s); or it may be that the latter in effect define existential conditions for the individual, apart from direct interaction. The influence of the family of orientation, insofar as this may be inferred from the correlation between level of social origin and level of achievement, is, of course, assumed throughout this study. In the present chapter, parental influence means something a little more specific; the relevant indicators are those that purport to tell whether the individual is subject to patterns of personal interaction with parents that lead to a stress on achievement. Although this variable has received a good deal of emphasis in the literature (Kahl, 1953; Bordua, 1960), the study remains to be executed in which the long-run influence of parents' ambitions for their children can be assessed. A few interesting clues turn up in our effort to include this type of variable in partial models of the process of achievement.

Indeed, it would be more accurate than modest to concede that "a few interesting clues" are primarily what we have to exhibit with regard to the influence of wives, friends, and classmates. Yet, we feel that the problem of incorporating such influences into models of the achievement process is sufficiently important that it should be carefully studied even in the absence of wholly ideal data. The effort to make such extensions of the basic model has proved to be most interesting in its own right.

#### 8.1. Wives and Mothers

This section describes an investigation of the relationships (a) of characteristics of wives with the occupational status of their husbands, and (b) of selected psychological and background factors of

mothers with their expressed desires for their children to attend college. One question raised for discussion centers on the role of the wife in shaping the career of her husband via the influence of such factors as her intelligence, achievement motivation, drive to get ahead, education, and social origins (occupational status of her father). The other issue poses the question of the effects of psychological characteristics of the mother in forming the aspirations she entertains for her children to attend college. Hence, at the core of both problems lies the whole issue of the interaction of demographic and psychological variables within the general context of the process of occupational achievement.

That wives may spur their spouses upward occupationally is expressed by the stereotype of the ambitious social-climber. Realistically, one might well expect wives to assist in molding the occupational careers of their husbands, at least in a statistical sense. The latter qualification underscores the issue of assortative mating. Marriages are made in social reality and not in heaven, and the woman brings a social and psychological dowry to the union. That this dowry is selected rather than randomly assigned is the crux of selective mating.

To explore the roles of wives and mothers in mobility patterns, we used the FGMA data set. The unique characteristics of these data require description, since they bear upon any analysis and interpretation derived from them.

Westoff and his collaborators (1961) sampled in the eight largest standard metropolitan areas (populations of two million or more) in the United States in 1956, excluding Boston; these areas included New York, Chicago, Los Angeles, Philadelphia, Detroit, San Francisco-Oakland, and Pittsburgh. Since fertility patterns constituted their main dependent variable, the investigators selected only couples whose second child was born during September of 1956. In addition, the couples resided at birth as well as at the time of interview in one of the eight SMA's; both spouses were white, once-married, and currently living together. Respondents ranged in age from 20 to 30 years; husbands employed in farm categories and/or spouses residing in institutions were excluded. Initial interviews produced 1,165 usable responses, one for each couple. The interviewers left a psychological questionnaire supplement with each partner to be completed and mailed to the investigators; 961 females and 941 males returned completed schedules. At least part of the psychological questionnaire included items from the Personality Research Inventory, designed by David E. Saunders of the Educational Testing Service at Princeton.

These specific features of the sample might raise doubts about its utility for research of a more general type. However, if one reasons that the couples in the FGMA study represent a common type of American family (young adults between 20 to 30 years of age, parents of two children, and residing in one of eight largest SMA's), then the peculiarity of the data is mitigated somewhat. As an external check, national

statistics from the OCG data (for men 20-64 years old residing in urbanized areas of one million or more inhabitants) were compared with the FGMA data. The frequency distributions of male respondents by their own occupations and their fathers' occupations in the two samples are shown in Table 8.1.1. Looking at the proportions of the respective column totals contributed by each occupational category for both samples, one sees that the two bodies of data neither compare exactly nor deviate suspiciously from each other. Hence, for the purposes of the analysis at hand, there is no apparent bias in the FGMA data.

Before embarking upon the empirical analysis of the data, some remarks are offered concerning the validity and reliability of several of the indices of psychological traits in the FGMA data.

To measure the intelligence of female respondents, a twenty-word, verbal IQ test was administered as part of the initial interview. This measure of intelligence, drawn from the work of Thorndike, comprises a short, verbal measure of intelligence which reliably reflected IQ in a survey setting. Thorndike (1942) assessed the validity of this measure in a published article; and Thorndike and Gallup (1944) applied the technique in an American survey. The results of these discussions of the verbal measure of intelligence cast no serious doubts on its use in the present context.

To measure wife's drive to get ahead, the FGMA investigators chose a device to discriminate "which values would be sacrificed to get ahead." Respondents were asked, for example:

In order to get ahead, would you be willing to become more active in community organizations and clubs not of your own choice?

Would you be willing to leave your friends?

Would you be willing to postpone having a child?

Would you be willing to keep quiet about your religious views in order to get ahead?

Would you be willing to have your husband take a chance on a job that he might be less certain of holding, if it had better opportunities?

The greater the number of "sacrifices" the woman said she was willing to make, the greater was her drive to get ahead, scoring 1 (low) to 9 (high). This method of measuring the drive to get ahead, while it is not new with the FGMA study (see Reissman, 1953), poses a problem of validity. The instrument purports to measure the amount of the drive or perhaps the intensity of desiring change by counting the number of "sacrificed" values. The burden of justification of the method falls on the theoretical structure of the questions themselves. First, in counting the number of sacrificial answers and comparing respondents on the basis of relative sacrifices (strength of drive) it is assumed that each person has an equal chance of sacrificing any of these values. Put in another way, each statement (value) should have an equal probability of being



Table 8.1.1.1.--Comparison of Occupational Distributions of Fathers and Sons in FGMA Data and OCG Sample of Urbanized Areas with Populations of One Million or More

Duncan's Occup. SES	North- Hatt Scores*	Frequency and Proportional Distributions							
		FGMA Data				OCG Data			
		Fathers		Sons		Fathers		Sons	
		Fre- quency	Propor- tion	Fre- quency	Propor- tion	Fre- quency	Propor- tion	Fre- quency	Propor- tion
0-4	33-38	59	.052	97	.083	453	.038	1013	.079
5-9	39-48	160	.141			960	.080		
10-14	49-54	77	.068	85	.073	2109	.175	647	.051
15-19	55-58	52	.046	76	.065	2081	.172	2087	.163
20-24	59-61	210	.185	254	.218	1327	.110	1539	.120
25-29	62-64								
30-34	65-66	138	.122	226	.194	2038	.169	2658	.207
35-39	67								
40-44	68-69								
45-49	70-71	296	.261	195	.167	1256	.104	1461	.114
50-54	72								
55-59	73-74								
60-64	75								
65-69	76-77	88	.078	81	.070	1036	.086	1876	.146
70-74	78-79								
75-79	80-81	34	.030	111	.095	566	.047	1174	.091
80-84	82-83								
85-89	84-86	20	.018	40	.034	248	.021	367	.028
90+	87-96								
Totals		1134	1.001	1165	0.999	12074	1.002	12822	.999

\*North-Hatt equivalents given to Duncan SES code. Westoff used five-point intervals of the North-Hatt scale. Therefore, even though the North-Hatt equivalents have been clustered to approximate Westoff's grouping of his intervals, the match is not perfect.

sacrificed, were all persons equal in drive to get ahead. In fact, however, it is hard to establish equivalence (in a "sacrificial" sense) in all the value statements. For example, does one require the same, more, or less drive in leaving one's friends as opposed to sending one's children to a less satisfactory school in order to get ahead? If there is a difference in drive in each case (an empirical proposition), then counting the number of sacrificed values gives a false estimate of the strength of the drive itself. Further, even if each value involves the same amount of drive, does each question on the schedule include only one value to be sacrificed? Similar questions arise with virtually any psychometric approach to personality. Here, as in all research making use of such instruments, there is a need for caution in interpreting both what is meant by the drive to get ahead as it is used in the present data and what can be concluded about the relationship of its content to other variables in an analytical sense.

Another conception used in the FGMA research involves the mother's aspirations for her children's college education. Remembering the time in the life cycle of these women and children when the interview was conducted, one is discussing aspirations for two children who are quite young (the younger actually is less than one year old). The utility of assessing the mother's aspirations at this juncture lies in being able to partial out any confounding influences of child's college-suitability (intellectual capacities and personal interests being still unascertained) on the kind and quality of maternal aspirations. One might expect, however, that the correlation between current expressed aspirations and later ones, based in part on the mother's assessment of the child's college-suitability, would be less than perfect (see the discussion of this point in section 8.2). Further, since our main interest in these aspirations is as contextual elements of a child's occupational career, the fact that the child's abilities and personal preference still are unknown does bear upon the predictive strength of mother's aspirations measured at this time.

The specific nature of the aspirational questions also should be mentioned. Four items, two multiple-choice and two open-ended, are used to elicit mother's educational aspirations for her children:

- Do you expect to send your children to college?
- How do you expect this college to be paid for?
- Would you send a daughter of yours to college even if it meant serious financial hardship?
- Would you send a son of yours to college even if it meant serious financial hardship?

Respondents were scored low to high (1-7) on the criteria below:

1--Do not expect to send children to college

- If it meant serious financial hardship:
- 2--wouldn't send either son or daughter
- 3--not send daughter; depends or don't know for son

- 4--depends or don't know for both
- 5--not send daughter; send son
- 6--depends or don't know for daughter; send son
- 7--would send both

Again the problem of the quantification of the categories can be solved in only an arbitrary way. That sending a son to college and not the daughter in times of financial stress indicates that a woman has higher (directional and quantitative) educational aspirations for her children than a woman who would send the daughter and not the son, is an ad hoc assumption which, although plausible, could be debated either way.

The final conceptual problem centers on the construct called "need achievement," or the woman's need to achieve. To measure this psychological quality, the FGMA questionnaire included several multiple-choice questions, some of which follow:

- 9. Can you always be counted on to try to do your best job regardless of how hopeless it may be?
- 20. Which do you do? Just what comes along as most of the crowd does or set yourself a goal of attainment that is quite hard?
- 42. Do you usually like work that requires accuracy in fine detail?
- 64. What kind of goals do you usually set for yourself? Low enough so that you can reach them without too much effort or too high for you to reach without a lot of effort?

If what the FGMA investigators meant by "need achievement" is what psychologists like McClelland and Atkinson mean when they speak of the need to achieve, then the measurement instruments appear to fall short of eliciting the same motivational components.

How do McClelland and Atkinson define achievement-related needs? Without becoming too mired in the jargon of psychology, one can describe the achievement motive by analogy. As a motive, the need to achieve is like the hunger motive, which also is a "need," although more biologically specified. The domain of the achievement motive, however, consists of only those instances "when an individual knows that his performance will be evaluated (by himself or by others) in terms of some standard of excellence and that the consequences of his actions will be either a favorable evaluation (success) or an unfavorable evaluation (failure). It is, in other words, a theory of achievement-oriented performance" (Atkinson, 1964, pp. 240-41). Further, the achievement motive might be conceived as a "capacity for taking pride in accomplishment when success at one or another activity is achieved" (p. 241).

Atkinson has developed a theory of achievement motivation which further qualifies the phenomenon. He states that in addition to the persistence of an enduring motive component, achievement motivation is associated with two situational factors or products of individual experience --the expectancy of success and the value of incentive. In further

qualifying achievement motivation, McClelland (1961) indicated the importance of the person's feelings of responsibility for outcomes, of his explicit knowledge of results, and of the existence of some degree of risk. In the context of these criteria, Atkinson's notions about expectancy of success take account of the person's subjective evaluation of success at a given task. Further, the person appraises a given task in terms of the reward he may enjoy should he complete it successfully or of the chagrin he may feel if he fails; hence for some tasks the incentive is greater than for others.

In terms of all three components of achievement motivation, Atkinson posits that the tendency to achieve success is a product (multiplicative model) of the motive to achieve, the expectancy of success, and the incentive value of success at a given task. The latter two components vary from task to task, while the motive itself endures as part of the personality. For a given task, the incentive value is the complement of the perception of success ( $I = 1 - P$ ). Tasks with no or little probability of failure (high probability of success) offer small reward for successful completion. Likewise extremely difficult tasks (low probability of success) promise almost certain failure and inspire few bold adventurers. From these general propositions, Atkinson (1964, pp. 240-247) deduces that where the motive to achieve (motive component) is relatively strong, one would expect that the person will select a task of intermediate difficulty (medium risk) so as to optimize both success and reward.

To measure achievement motivation, McClelland and Atkinson maintain that Henry Murray's TAT pictures best allow a respondent to project his motive-related imagery. Any other method of eliciting achievement-related motives fails to encompass these themes in a contextual, holistic fashion and may not generate comparable measures of the need to achieve. Because of their partial effectiveness, questionnaire items may deal with one aspect of achievement need which, taken by itself, has no unitary significance. For example, FGMA question 9 cited above may evoke a person's persistence independently of his need to achieve. Question 20 asks about setting "hard" goals, while Atkinson's theory of n Ach deals with moderately difficult, realistic goals. Similar criticisms could be made for other FGMA items.

This digression into the limitations of the FGMA measure serves no other purpose than to warn the wise that all who need do not achieve. The FGMA instrument may well have measured some internally consistent achievement syndrome (as indicated by a factor analysis), but that it taps the achievement motive in the McClelland and Atkinson sense is doubtful; only correlational analysis of projective and questionnaire results from the same population can dispel the doubt. For the analysis which follows, the label, need to achieve, abbreviated as n Ach will be used for convenience without assuming correspondence with McClelland and Atkinson.

Having qualified the data, we may proceed with the analysis. Our basic model suggests the treatment of father's occupational status (X), father's education (V), education of respondent (U), and respondent's first job after completion of education (W) as determinants of current occupational status (Y). From the FGMA data, correlations among X, U, W, and Y were obtained and are compared in Table 8.1.2 with those for males, age 25-34, in the OCG data. Actually this age group in the 1962 OCG study is roughly the same cohort studied in FGMA five years earlier, when the men were 20-30 years old. However, the size of place, marital status, and fertility specifications of the FGMA sample may account for some of the larger discrepancies in the size of the correlation coefficients. For example, the closer association between W and Y in the FGMA data may reflect the effects of marriage and children in preventing a man from leaving the occupational status he occupied at marriage. Then, too, some of the discrepancies reflect the different methods of scoring occupations in the two studies. The OCG study used Duncan's occupational status code, and FGMA used the North-Hatt prestige scores. Variable W in the OCG study represented first job after completion of education; for FGMA it was the job at marriage. Naturally, coding errors and lack of reliable respondent reporting also render complete corroboration impossible. In short, while the specific results seem somewhat dissimilar, the general pattern of the relationships appears analogous.

Table 8.1.2.--Comparison of Zero-order Correlations of Mobility Variables in FGMA Data and for OCG Males, Age 25-34, Nonfarm Background

	Variables*							
	X		U		W		Y	
	OCG	FGMA	OCG	FGMA	OCG	FGMA	OCG	FGMA
X	--		.411	.340	.380	.267	.366	.297
U			--		.574	.541	.657	.641
W					--		.584	.640

\*X, Y, and W measured on North-Hatt scale for FGMA; on Duncan's occupational status scale in the OCG data. W is occupation at marriage for FGMA; first job after completion of education for OCG.

Figure 8.1.1, which is compatible with our basic model, represents occupational achievement (to the date of the survey) as a function of the husband's own background and prior achievement. If, hypothetically, one were to suggest that husband's achievement depends only on the wife's characteristics, the best estimate of the degree of such dependence obtainable from the FGMA data is shown in Figure 8.1.2. Of

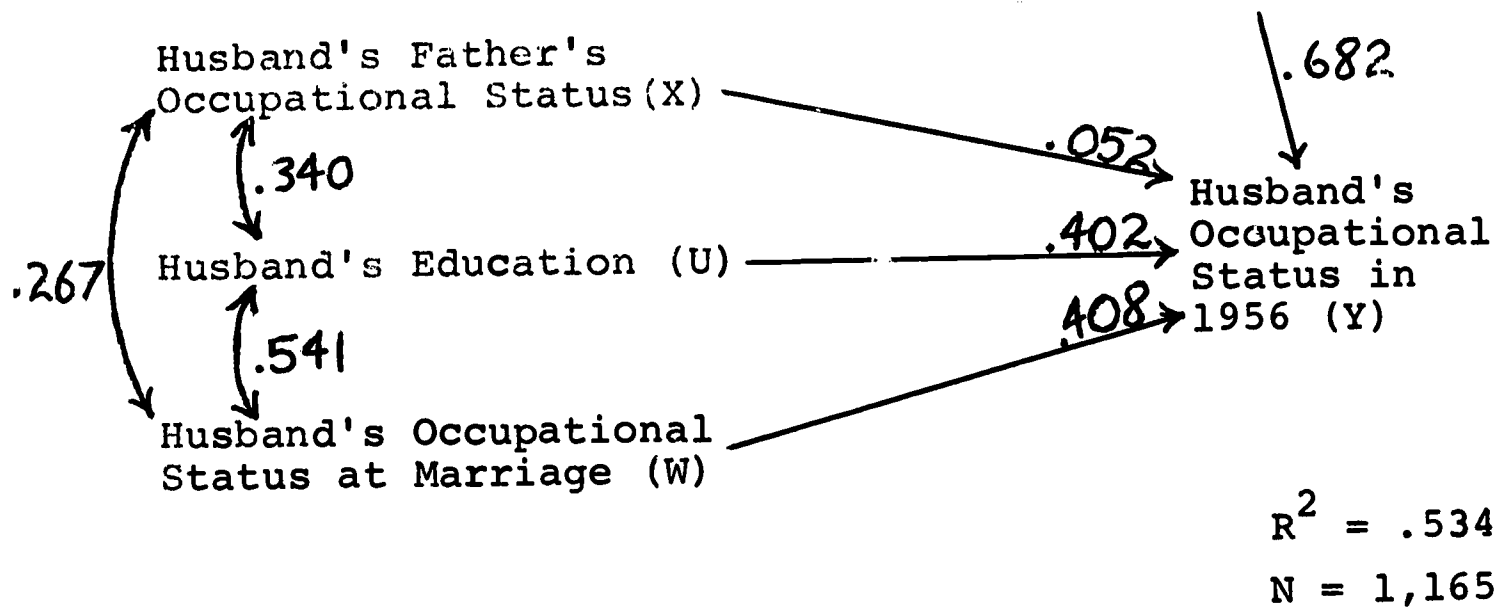

Figure 8.1.1. -Path Diagram Showing Husband's Characteristics as Determinants of Husband's Occupational Status (FGMA Data).

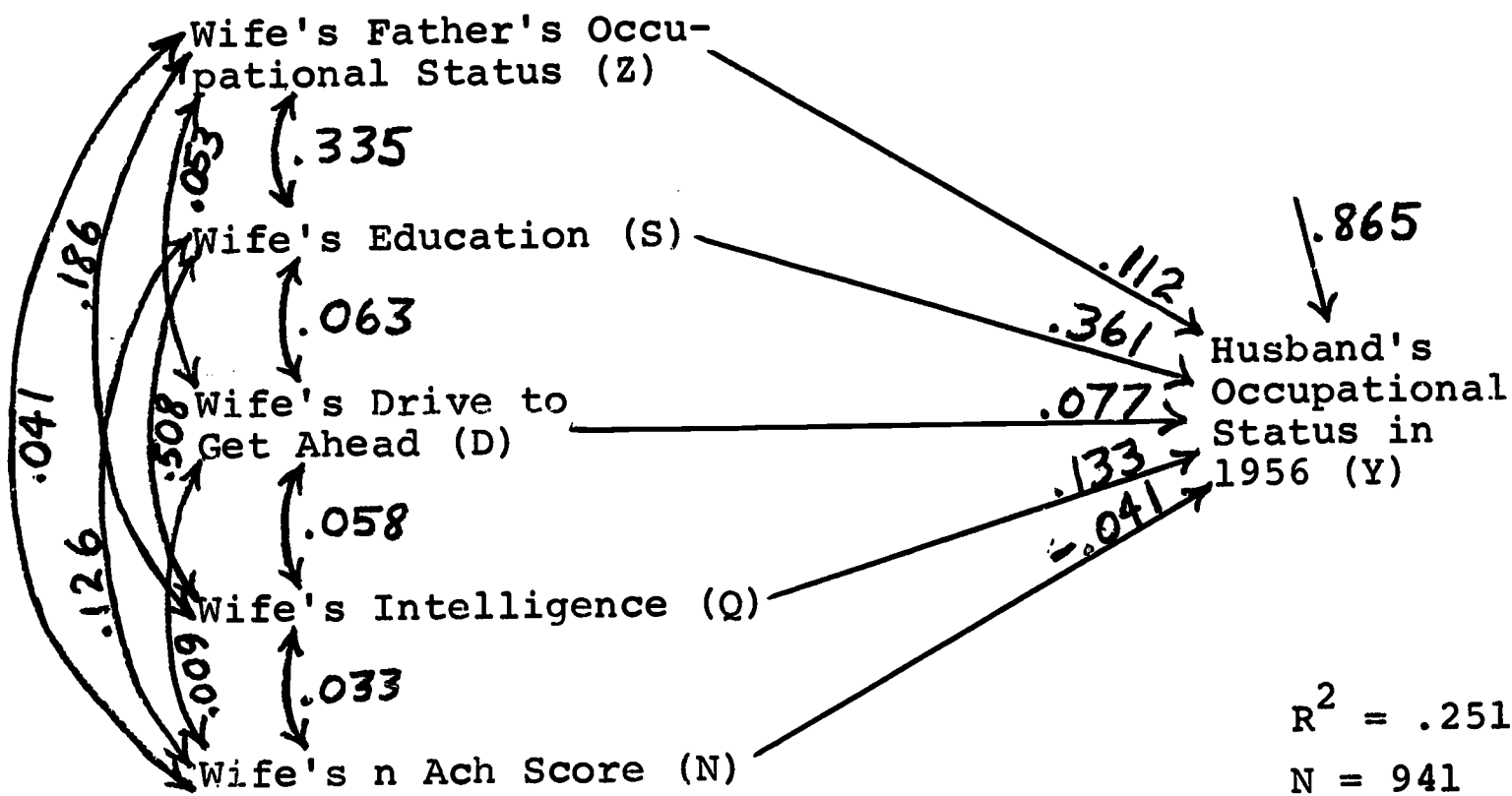

Figure 8.1.2.--Path Diagram Representing Husband's Occupational Status as Depending on Wife's Psychological and Background Characteristics (FGMA Data).

the two sets of predictors, the husband's characteristics are evidently the more powerful:

$$R^2_{Y(WUX)} = .534 \text{ vs. } R^2_{Y(NQDSZ)} = .251.$$

This unsurprising result, however, does not answer our main question, to wit: If one knows (for example) wife's IQ, n Ach score, strength of drive to get ahead, origin status (her father's North-Hatt score), and education, how much additional variation do these variables explain after X, U, and W have exerted their influence? Before examining the evidence, one might be reminded that to enlarge appreciably the amount of explained variation, the new variables should operate somewhat independently of W, U, and X and correlate only moderately with each other.

Computing the multiple regression of Y on both the husband's background variables (W, U, and X) and the wife's background and psychological variables (Z, S, D, Q, N), we obtain the multiple  $R^2 = .538$ . Hence, the adding of wife's background and psychological variables to the husband's factors only increases the explained variance of Y by .004

$$(R^2_{Y(WUXZSDQN)} - R^2_{Y(WUX)})$$

In addition, all beta coefficients for wife's characteristics, except education, fall below two times their standard errors.

Adding wife's education (S) into the path diagram for the husband's factors (Figure 8.1.3) confirms that whatever influences the wife contributes to changes in Y operate mainly through her education, inasmuch as  $R^2_{Y(SWUX)} = .536$ . Note that S relates slightly more importantly to Y than does X, in this diagram.

These results confirm the conclusion of Blau and Duncan (1967, pp. 341-346) that characteristics of wives have little effect on husband's occupational achievement, independently of the characteristics of the husbands, given the moderate to strong patterns of assortative mating on socioeconomic characteristics found in American data. The special interest in the present result stems from the fact that the FGMA data include some measures of the wife's psychological traits that might have been supposed (before the fact) to have strong and independent bearing upon the course of the husband's career even if her socioeconomic background does not. The data do not support such an hypothesis.

While wives apparently contribute little directly to their husbands' careers--at least by way of their socioeconomic characteristics and personality traits--perhaps in their capacities as mothers they supply some impetus for the mobility of offspring, specifically in terms of children's education. McClelland (1961) and Rosen and D'Andrade (1959) have stated independently that mothers high in need achievement motivate their children similarly, especially through early mastery (achievement) training, few negative sanctions, and positive physical affection. Granting this hypothetical relationship, one might expect a positive association between a mother's n Ach and her aspirations for her

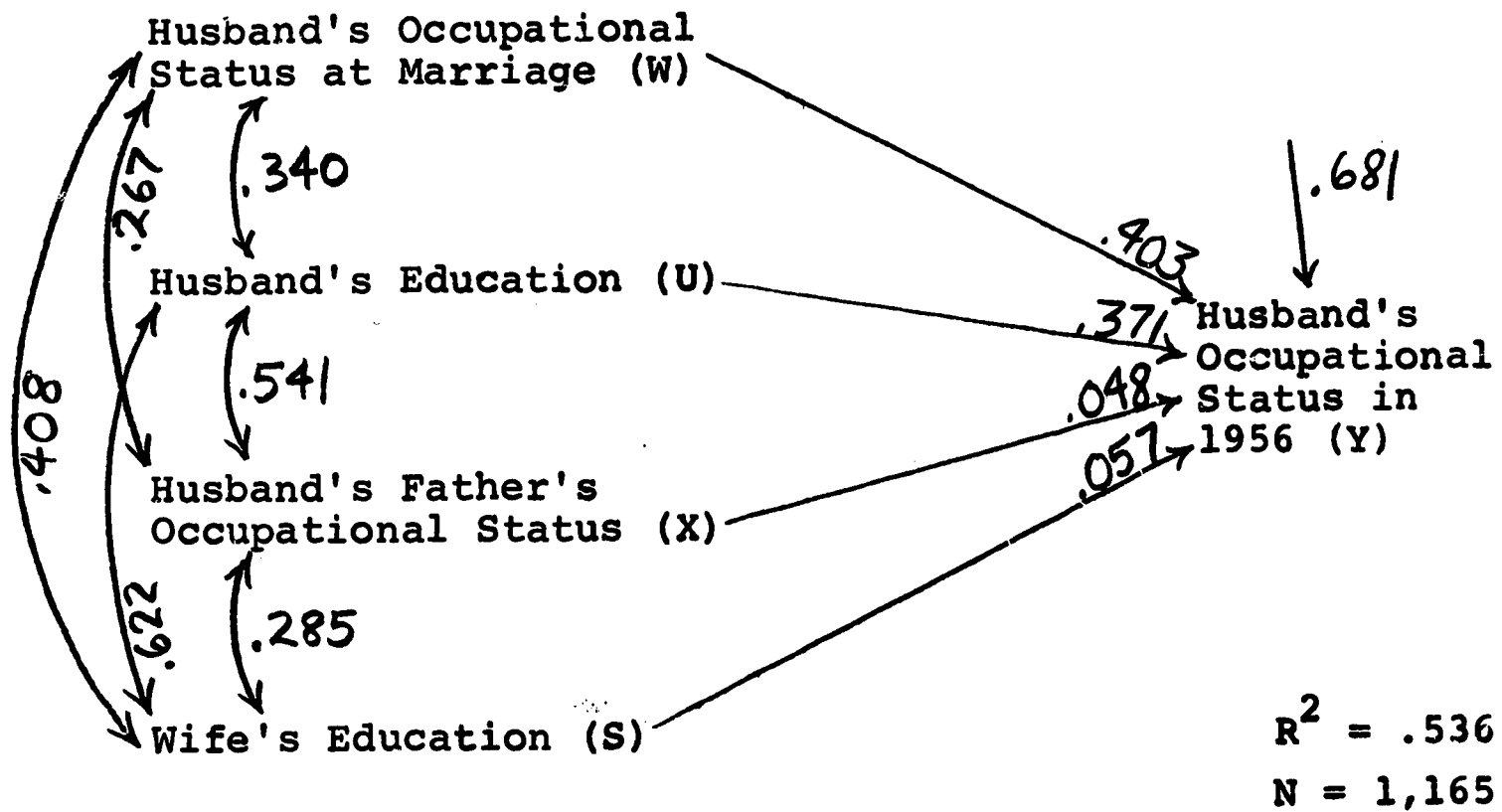

Figure 8.1.3.--Path Diagram Representing Husband's Occupational Status as a Function of His Background and Wife's Education (FGMA Data).



children's college education. It was assumed that certain other variables should also be connected with these educational aspirations; such linkages are illustrated in Figure 8.1.4. Notice that the model involves all possible paths leading from antecedent variables.

The rationale for the arrow from N to A has been justified conceptually. Arrows also lead from S to A, and Z to A. It seemed logical that some tie might bind the length of mother's own educational experience with the aspirations she entertains for her children. Further, maternal education itself can be understood as partly a function of scholastic aptitude or IQ, as partly determined by the motivations called out for the educational experience (N), and as somehow influenced by the differential distribution of educational values and motivation within various occupational strata (Z) (Hyman, 1953). That these stratum-linked values may directly shape the mother's aspirations, apart from the indirect relationship through education, is noted by the arrow from Z to A. Two arrows run to N, one from Z and one from Q. McClelland (1953, pp. 63-66) makes the case that IQ might be a factor in need achievement, although the precise nature of that connection remains unexplored. Since child-rearing practices often mold achievement motivations, and since the optimal "achievement-rearing" norms appear stratum-linked (Winterbottom, 1958; McClelland, 1953; Rosen and D'Andrade, 1959), the arrow from Z to N is drawn. The unanalyzed correlation of Z and Q arises from several pieces of literature, citing a correlation between origin status and IQ scores (see section 6.2). To complete the diagram, three residual arrows are included.

Path coefficients were computed by a multiple regression routine. Noting that many of the initially assumed paths failed to achieve acceptable size (twice the standard error), a new diagram was constructed as Figure 8.1.5. According to the revised model, only two direct paths extend from the mother's background and personality to her aspirations for her children's education. Two variables, maternal education (S) and n Ach (N) account for 5.7 per cent of the variation of maternal aspirations (A). The larger magnitude of the path for S denotes the greater relative importance of mother's education for her later educational aspirations (child directed). In fact, all prior factors (including a portion of n Ach) appear to exert their influences indirectly or jointly through maternal education (primarily) and n Ach (secondarily). For complete arithmetical consistency Figure 8.1.5 would have to show the residual factor in A as correlated to the extent of .046 with Q and .018 with Z, but these are neglected in the interest of simplicity.

From the model in Figure 8.1.5, if its present form is accepted, one concludes that mothers may play a role in the occupational careers of their children via their educational aspirations for them. In terms of the influences on the aspirations themselves, background and psychological factors work through maternal education and n Ach, particularly the former.

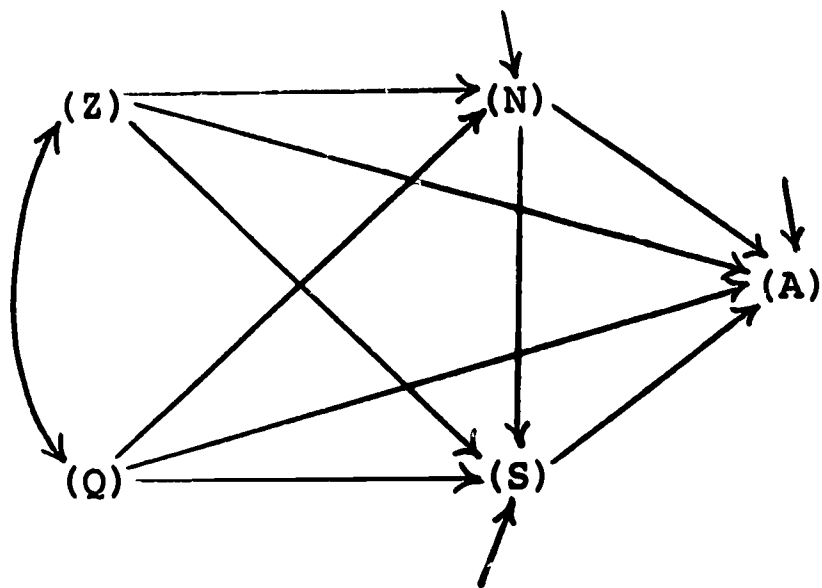

Key

- Z: Mother's Status Origins (Her Father's Occupational Status)
- Q: Mother's Intelligence
- N: Mother's n Ach Score
- S: Mother's Education
- A: Mother's Aspirations for Children's Education

Figure 8.1.4.--Initial Path Diagram for Explaining Mother's Aspirations for Her Children's Education.

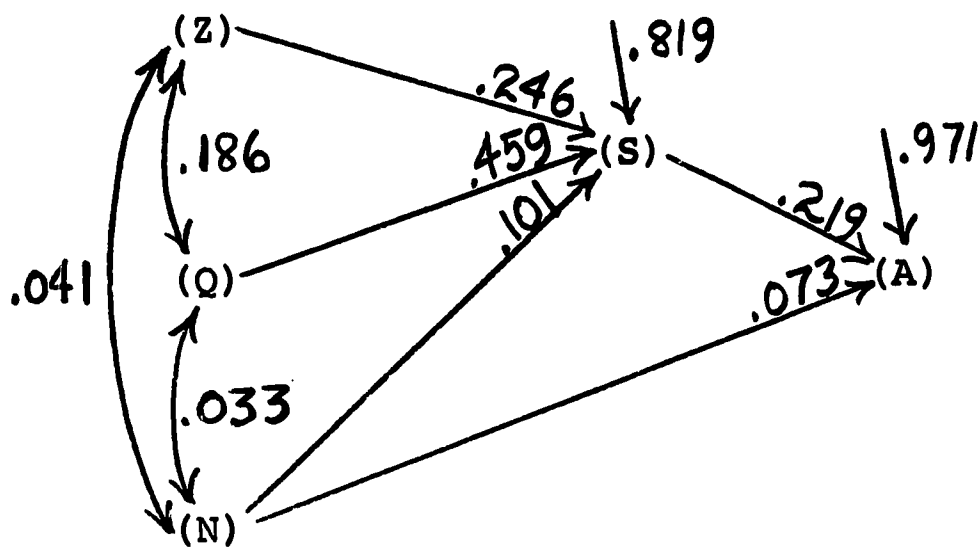

$R^2_{A(SN)} = .057$   
 $R^2_{S(ZQN)} = .328$   
 N = 941

Key

(See Figure 8.1.4)

Figure 8.1.5.--Revised Causal Model of Mother's Aspirations for Children's Education.

Let us now consider an extreme hypothesis: that characteristics of a child's family affect his education only via his mother's educational aspirations for him. Figure 8.1.6 illustrates the situation where the father's occupational status (Y), his education (U), and the mother's education (S) do not affect directly the son's educational attainment (U'), but only indirectly through the mother's aspirations for her child (A); the only direct effects are from the mother's aspirations themselves.

The zero-order correlations for  $r_{YU'}$ ,  $r_{UU'}$ , and  $r_{SU'}$  for Figure 8.1.6 each can be expanded and expressed as the product of two correlations:

$$r_{YU'} = r_{AU'} r_{AY} \quad (1)$$

$$r_{UU'} = r_{AU'} r_{AU} \quad (2)$$

$$r_{SU'} = r_{AU'} r_{AS} \quad (3)$$

The FGMA data do not permit computation of  $r_{YU'}$ ,  $r_{UU'}$ ,  $r_{SU'}$ , and  $r_{AU'}$ . However, the OCG tabulations for nonfarm men between the ages of 25 and 34 can be used as substitutes for two correlations ( $r_{YU'} = .41$  and  $r_{UU'} = .42$ ). Taking these two correlations along with those in FGMA one can solve the above three equations for  $r_{AU'}$  and  $r_{SU'}$ . Note however that equations (1) and (2) contain separate solutions for  $r_{AU'}$ . If these two solutions are dissimilar, then one must reject Figure 8.1.6 as drawn on the basis of its mathematical inconsistency. Substituting the correlations (see Table 8.1.3) into the equations above:

$$.41 = r_{AU'} (.19)$$

$$\frac{.41}{.19} = r_{AU'}$$

and

$$.42 = r_{AU'} (.29)$$

$$\frac{.42}{.29} = r_{AU'}$$

One can see that in both equations  $r_{AU'}$  exceeds 1.00.

These computations indicate that Figure 8.1.6 cannot be accepted; mother's aspirations for her child's education cannot by themselves transmit the effects of father's occupation and education and the mother's own education to their son's educational attainment.

While Figure 8.1.6 clearly must be rejected, could some modification be made which would allow a consistent solution to the diagram? One possible modification appears in Figure 8.1.7, which adds a direct effect of Y on U' to the other direct effect of A on U'. One can expand the three correlations again as follows:

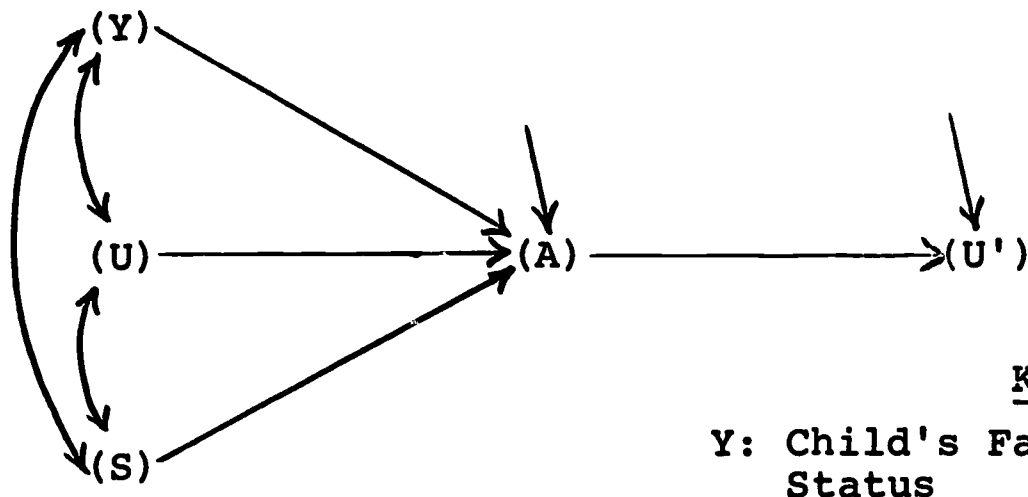

- Key
- Y: Child's Father's Occupational Status
  - U: Child's Father's Education
  - S: Child's Mother's Education
  - A: Mother's Aspirations for Child's Education
  - U': Child's Potential Education

Figure 8.1.6.--Hypothetical Model: Background Influences on Son's Education through Mother's Aspirations Only.

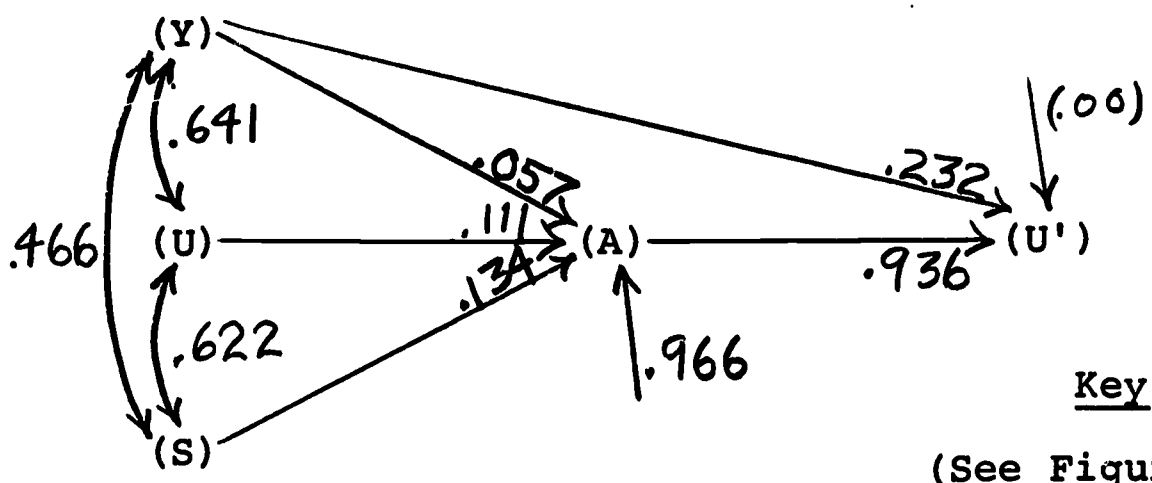

- Key
- (See Figure 8.1.6)

Figure 8.1.7.--Hypothetical Model Modified.

Table 8.1.3.--Zero-order Correlation Matrix for FGMA Data

Variable*	X	U	W	Y	Z	S	D	Q	N	A
X	...	.340	.267	.297	.226	.285	.109	.188	.056	.106
U		...	.541	.641	.280	.622	.112	.434	.018	.228
W			...	.640	.263	.408	.091	.299	.039	.139
Y				...	.260	.466	.113	.340	.014	.191
Z					...	.335	.053	.186	.041	.093
S						...	.063	.508	.126	.228
D							...	.058	.009	.095
Q								...	.033	.158
N									...	.100

**\*Key:**

- X: Husband's Father's Occupational Status
- U: Husband's Education
- W: Husband's Occupational Status at Marriage
- Y: Husband's Occupational Status in 1956
- Z: Wife's Origin Status (Wife's Father's Occupation)
- S: Wife's Education
- D: Wife's Drive to Get Ahead
- Q: Wife's IQ
- N: Wife's n Ach
- A: Wife's Aspirations for Her Children's Education

$$r_{YU'} = p_{U'Y} + p_{U'A}r_{AY} \quad (1)$$

$$r_{UU'} = p_{U'Y}r_{YU} + p_{U'A}r_{UA} \quad (2)$$

$$r_{U'S} = p_{U'Y}r_{YS} + p_{U'A}r_{AS} \quad (3)$$

Similarly, one can expand the three correlations containing A:

$$r_{AY} = p_{AY} + p_{AU}r_{UY} + p_{AS}r_{SY} \quad (4)$$

$$r_{AU} = p_{AU} + p_{AY}r_{YU} + p_{AS}r_{SU} \quad (5)$$

$$r_{AS} = p_{AS} + p_{AU}r_{US} + p_{AY}r_{YS} \quad (6)$$

Equations 1, 2, and 3 give solutions for  $p_{U'Y}$ ,  $p_{U'A}$ , and  $r_{U'S}$ ; equations 4, 5, and 6 solve for  $p_{AY}$ ,  $p_{AU}$ , and  $p_{AS}$ :

$$\begin{array}{ll} p_{U'Y} = .232 & p_{AY} = .057 \\ p_{U'A} = .936 & p_{AU} = .111 \\ r_{U'S} = .38 & p_{AS} = .134 \end{array}$$

If one accepts the logic of Figure 8.1.7, then one cannot reject the model on the basis of either logic or mathematics. Accepting the algebra allows one to calculate the correlation  $r_{AU'}$  (unobserved in either OCG or FGMA data) as follows:

$$\begin{aligned} r_{AU'} &= p_{U'A} + p_{U'Y}r_{YA} \\ &= (.936) + (.232)(.19) \\ &= .940 \end{aligned}$$

One may question the magnitude of  $r_{AU'}$  as calculated from the model. However, since the model is drawn to represent a logical conception of how mothers influence their son's educational attainment, to question the correlation is to question the present representation of the relationships. Certainly one can make a case for drawing direct paths between U and U' and S and U' as well as Y and U'. For heuristic and computational reasons only was the latter ( $p_{U'Y}$ ) included rather than any or all of the other possible direct paths. Had these other or additional direct influences been included, however, the magnitude of  $r_{AU'}$  surely would have been less. Of course, any such calculated (hypothetical) correlation must be substantiated by sample estimates from real data.

Nevertheless, one can conclude from Figures 8.1.6 and 8.1.7 that by themselves, mother's aspirations for her children's education cannot account for the educational attainment of her son as it is influenced by the education of both parents and the occupational status of the father.

## 8.2. On the Development of Parents' Aspirations

The results in the previous section leave open the question of how and how much the aspirations of parents for their children's success may influence the children's achievement, although these results suggest that maternal aspirations can hardly be the sole variable mediating the intergenerational correlation of socioeconomic variables. It was noted that maternal aspirations are expressed in the FGMA data as of the time the offspring is still in infancy. We must reckon with the possibility that parental aspirations have a developmental cycle of their own which responds to characteristics of the child becoming manifest only as he matures.

Our discussion of this question will be quite tentative, and it seems appropriate to stipulate at the outset the spirit in which the discussion is offered.

In sociological literature one frequently finds discussions based on the juxtaposition of results from several studies. These discussions include conjectures to account for discrepant results or hypotheses suggested by the comparison of findings: "Investigator A found such and such, while Investigator B discovered so and so; putting the two results together, we would conclude this and that."

Our contention is that such discussion is valuable, but that much of its value usually is lost for lack of a disciplined approach to the combination of sets of findings. Exploration of the implications of a specific causal model will often serve to rule out some conjectures while lending credence to others. The latter, then, become prime candidates for empirical testing.

This contention is illustrated here by considering a causal model pertaining to the development of parental aspirations for children's higher education. Two sets of apparently disparate data on the subject are at hand. In section 8.1 we presented an analysis of the FGMA data relating wife's stated aspirations for her children's college education to her own educational attainment, that of her husband, and his occupational status. We also have access to a second set of unpublished correlations (WISC data set) computed by William H. Sewell from his study of Wisconsin high school seniors. Only the data for boys are considered here; these boys were asked in 1957 to indicate the degree to which their parents encouraged them to think of going to college.

The results in section 8.1 indicate a multiple correlation of  $.26 = R_A(YUS)$  for the relationship of wife's aspirations for children's education to the composite of the three socioeconomic status variables. Sewell's data indicate a correlation of  $.40$  between parents' encouragement and a composite SES score, which includes mother's education, father's education, father's occupation, and some items concerning the boy's perception of the family's financial resources.

For purposes of discussion, we shall assume that these two results are comparable in respect to both the definition of a composite SES variable and the reporting of parental aspiration. Flaws in the assumption will be evident, but this is only the first of several assumptions that must be made in order to draw any conclusion from a comparison between the two studies.

The most evident discrepancy between the two inquiries--or, at any rate, the one on which the present discussion turns--is that they pertain to different stages in the family cycle. The FGMA respondents were interviewed shortly after the birth of the second child and, in most cases, the older child would have been still of pre-school age. The Wisconsin seniors reported parents' aspirations as of the time the respondents were almost old enough to go to college. The substantive assumption for our discussion is that parental aspirations, while partly a function of socioeconomic background, develop over time and partly in response to the conception that parents form of the child's ability to profit from higher education. (We are neglecting the fact that the family's socioeconomic status may also change during this period, though with some additional evidence, it should be possible to incorporate this development into a model as well.)

Figure 8.2.1 presents two models which embody this interpretation. In both cases, it is assumed that family socioeconomic status is correlated with the child's intelligence (though the source of this correlation is not explicated by either model). At the time the "early aspiration" of the parents (actually, the mother, in the FGMA data) is reported, presumably the intelligence of the child is still indeterminate, so that the only reason why intelligence and parental aspiration should be correlated is because of their common correlation with socioeconomic status, taking the latter as a cause of aspiration. By contrast, when the "later aspiration" is ascertained, the parents will be reflecting in their encouragement of the son not only their status position but their knowledge of how bright or dull he may be. At the same time, it is assumed that there is a carryover or persistence of the aspirations as they were tentatively formed at the earlier date. The degree of persistence is one of the quantities to be estimated by the model.

While they are the same with respect to the foregoing interpretations, the two models exhibited in Figure 8.2.1 differ in regard to the role of the child's actual performance in high school, as indicated by his rank in his high school class. The first model, which has to be rejected for reasons noted shortly, assumes that the formation of parental aspirations at the later date depends directly (in part) on high school rank, but only indirectly on intelligence. The second model, which cannot be rejected with the data at hand, makes the contrary assumption, that parental aspiration directly depends in part on the son's intelligence and is correlated with high school rank only because school rank and aspiration have common causes.



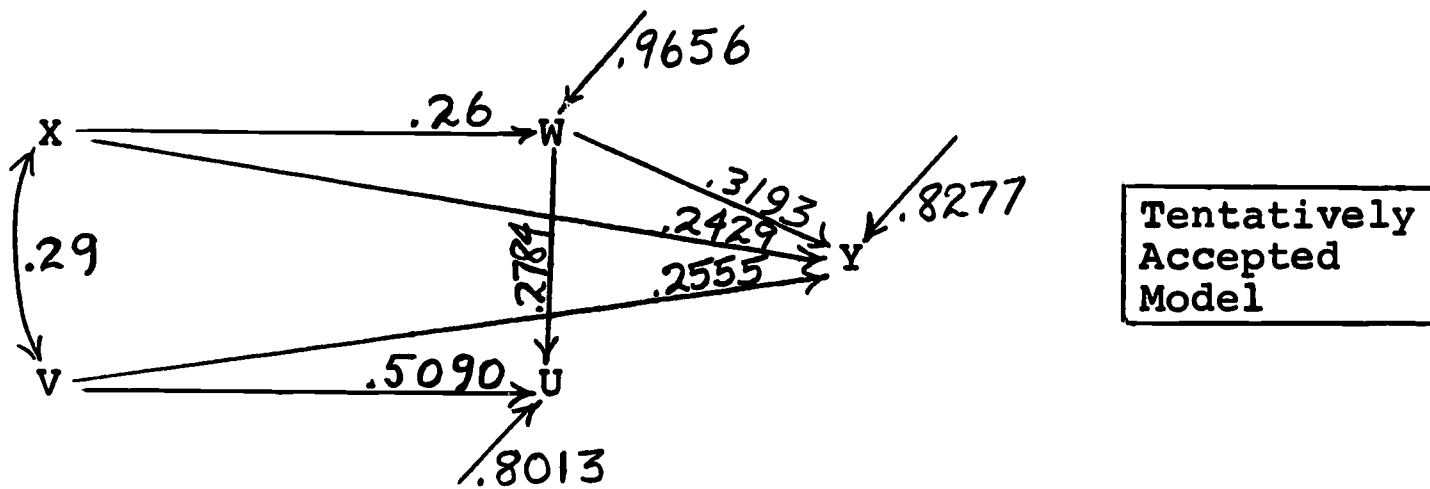
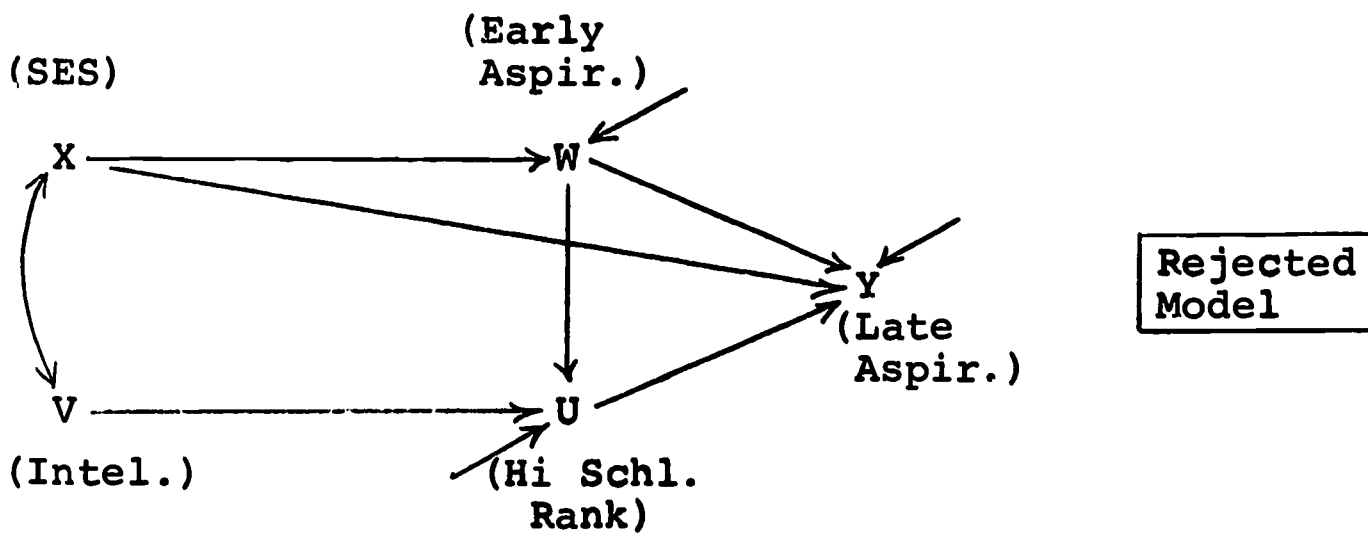

Figure 8.2.1.--Development of Parental Aspiration for Child's College Education, Depending on Background Factors, as Represented in Two Models. (Path coefficients estimated from WISC data set; see Table 8.2.1.)

Still another assumption shared by both models is that parental SES influences school achievement (high school rank) only indirectly, via its initial correlation with child's intelligence, or by way of its influence on aspirations for the child's educational success. In this respect, early aspiration is treated as an intervening variable partially accounting for the correlation of SES with high school rank.

The operational role of the assumptions stated in the last two paragraphs is to set at zero two of the possible path coefficients in a system comprising two initial variables and three dependent variables. In both models,  $p_{UX} = 0$ ; in the rejected model,  $p_{YV} = 0$ , while in the nonrejected model the alternative assumption that  $p_{YU} = 0$  is made. It should be mentioned that some alternative values of the omitted paths might be assumed, but some such assumptions must be made, for there are 10 pairs of variables in the system, but only 7 observed correlations (see Table 8.2.1). One may be skeptical of the assumption that the two omitted paths are identically zero, but our interpretation suggests that one might well have conceptual reasons for thinking them to be of quite secondary significance.

Table 8.2.1--Correlation Matrix for Analysis of Parental Aspirations  
(Sources noted below diagonal)

Variable	Variable (see stub)				
	X	V	W	U	Y
Socioeconomic status (X)	...	.29	(.26)	.22	.40
Intelligence (V)	s	...	[.0754]	.53	.35
Early aspiration (W)	w	d	...	[.3168]	[.4017]
High school rank (U)	s	s	d	...	.29
Late aspiration (Y)	s	s	d	s	...

Sources: s--unpublished correlation for male high school seniors in WISC data set.

w--computed in section 8.1 from FGMA data.

d--derived in obtaining the solution shown in Figure 8.2.1.

A note on the solution for the numerical values of the path coefficients in the nonrejected model appears at the end of this section. The procedure is much the same for the two models, but the results are quite different. The solution for the rejected model includes a value of  $p_{YV} = -1.06$  and one of  $r_{YW} = -.76$ . This is neither a mathematically impossible result (since a path coefficient may take on an absolute value greater than unity), nor one that can be absolutely ruled out on substantive grounds, since we have no independent evidence on the persistence of parental aspirations. The result is, however, quite

incredible, for it would imply that parental aspirations tend to reverse themselves over a period of a little more than a decade: parents with initially high aspirations come to have low aspirations, while those with initially low aspirations come to have high aspirations. On the basis of the data at hand, therefore, this model is rejected as implausible. It is not out of the question, however, that a data set free of some of the factors of noncomparability between the FGMA and Wisconsin studies would prove to be compatible with the first model.

The numerical values entered for the second model in Figure 8.2.1 are not on the face of the matter implausible, nor do the three derived correlations shown in Table 8.2.1 arouse suspicion. It appears that the strongest direct influence on later aspirations is the persistence of early aspirations, as represented by a derived correlation,  $r_{YW} = .40$ . One might have expected this to be higher, but the essence of the interpretation advanced here is that the early aspirations are not crystallized, in view of their remoteness from the actual decision point and in view of the absence of information on the child's ability, one of the significant determinants of the more realistic aspirations. Socio-economic status affects later aspirations, not only indirectly via its correlation with intelligence and its influence on the initial formation of aspirations, but also to an appreciable degree via a direct path.

There is some interest as well in the path  $p_{UW}$  representing the effect of early aspiration of parents on school achievement and one of the ways by which parental status affects that outcome. The path coefficient is appreciable, .28, and the corresponding derived correlation is .32. This sector of the causal diagram, of course, merely represents in a drastically summarized fashion the end result of a complex and continuous process. Presumably parents with high educational aspirations begin to encourage their children's school work from the earliest ages and continue to reinforce behavior producing success on the child's part.

The derived correlation between early aspiration and child's intelligence is a mere .08, reflecting the assumption that parent's knowledge of the intelligence of a child of two or three years can hardly be accurate and can hardly have much to do with aspirations for his further education as formulated at that time. The reader might wish to insist that how bright the parents think the child is may affect their early aspirations. If actual brightness is only slightly correlated with parental assumptions about intelligence, however, we could acknowledge this possibility without having to alter the diagram in any essential way. Perhaps parental assumptions about intelligence may serve as an intervening variable between socioeconomic status and educational aspirations for children.

One significant difference between the two models, as it relates to the use of the empirical data, may be noted. The rejected model posits a direct causal role for high school rank in producing later parental aspirations, and this factor, therefore, could not be dropped from the model. In the nonrejected model, on the other hand, a complete

system would still be present if variable U and the two path coefficients,  $p_{UW}$  and  $p_{UV}$ , were simply erased. In this instance, variable U merely plays the role of an auxiliary variable which implicitly conveys certain information about the relationships among the other variables in the system, given that knowledge of their intercorrelations is incomplete. Once the solution is reached, U may be dropped, but it (or some other variable playing a similar role) is required to obtain the solution.

Note on the solution. Making use of the basic theorem of path analysis, we may write down the various equations providing components of the several correlations, known and unknown, in the system. These appear in the order in which they are used in obtaining the solution for the second (nonrejected) model.

(1)  $r_{XV}$  is given.

(2)  $r_{VW} = p_{WX}r_{XV}$ . But  $p_{WX} = r_{WX}$ ; hence  $r_{VW} = (.26)(.29)$

(3)  $r_{UX} = p_{UV}r_{XV} + p_{UW}r_{WX}$

$$r_{UV} = p_{UV} + p_{UW}r_{VW}$$

By virtue of step (2), all the correlations in these two equations are known; hence they may be solved for  $p_{UV}$  and  $p_{UW}$ .

(4)  $r_{WU} = p_{UW} + p_{UV}r_{VW}$ , yielding  $r_{WU}$  immediately.

(5)  $r_{YU} = p_{YW}r_{WU} + p_{YX}r_{XU} + p_{YV}r_{VU}$

$$r_{YV} = p_{YW}r_{VW} + p_{YX}r_{XV} + p_{YV}$$

$$r_{YX} = p_{YW}r_{WX} + p_{YX} + p_{YV}r_{VX}$$

Correlations are known or obtained from preceding steps, so that these three equations may be solved simultaneously for  $p_{YW}$ ,  $p_{YX}$ , and  $p_{YV}$ .

(6)  $r_{YW} = p_{YW} + p_{YX}r_{WX} + p_{YV}r_{VW}$ , which, on entering previously obtained values, yields  $r_{YW}$ .

(7) Residual paths are obtained by the usual method. Thus residual for W is  $\sqrt{1 - p_{WX}^2}$  and residual for U is  $\sqrt{1 - p_{UW}r_{WU} - p_{UV}r_{UV}}$ , for example.

It may be noted that this solution includes no set of equations with the symmetrical form of the normal equations for multiple correlation. The "Doolittle method" of solution is not available, therefore, but one can use any convenient routine involving determinants or matrix inversion

available at a computing center. The solution includes derived correlations which fill out the correlation matrix. If one uses all the correlations, including these, in a recursive regression setup--regressing W on X and V; U on W, X and V; and Y on U, W, X, and V--he will, in fact, obtain the path coefficients as beta coefficients in the regressions, including (within errors of rounding) zero values for the two omitted paths.

Caveat. The reader should be clear about what is here attempted and not attempted, what is achieved and what is not achieved. By our juxtaposition of data from two sources, implemented by a set of assumptions needed to deduce any relationship between them, we have not "proved" anything about how aspirations develop. We have only taken the best evidence we know of in a suitable form and shown that one account of this process cannot be rejected out of hand, given the assumptions made. The work is to be described as conjecture, speculation, or "theorizing," as may be appropriate in the light of the reader's terminological taste. We have carried out this phase of "interpretation" by the exercise of what some critics might well term "methodological virtuosity," rather than by purely verbal means. There is no virtue in virtuosity as such--and there is actually little "virtuosity" here in any event--but there is virtue in trying to make an interpretation cogent and self-consistent. As such, it is more readily rejected when additional evidence comes to hand than is one that enjoys the cloak of verbal ambiguity.

### 8.3. Parents and Peers

The most comprehensive model of social influences developed in this project is depicted in Figure 8.3.1. The properties of this model and techniques of estimating its parameters are described in detail in Report #7, and the discussion here summarizes only a few salient points. The data pertain to a population of 17-year old boys [see section 3.1, para. (a)].

This model, like those suggested in section 7.5, takes expressed aspirations as indicators of some underlying motivational state, symbolized as "G" or "H" (the term "Ambition" is used as a convenient label in Report #7). Here it is assumed that the hypothetical motivation variable depends on family socioeconomic status (SES), intelligence, and parental aspirations for the son's success. In addition, it is influenced in two ways by interaction with peers. First, it is allowed to be influenced directly by the SES of the friend's family, an assumption that fits with the notion that role models may be found in a family other than one's own. Second, the motivational variables of respondent and friend are taken to be simultaneously or jointly determined within the model so that each may be thought of as influencing the other. This kind of "reciprocal causation" is a good deal more difficult to handle than is the "one-way causation" represented in recursive models. Hence, the present results are presented quite tentatively, having been secured

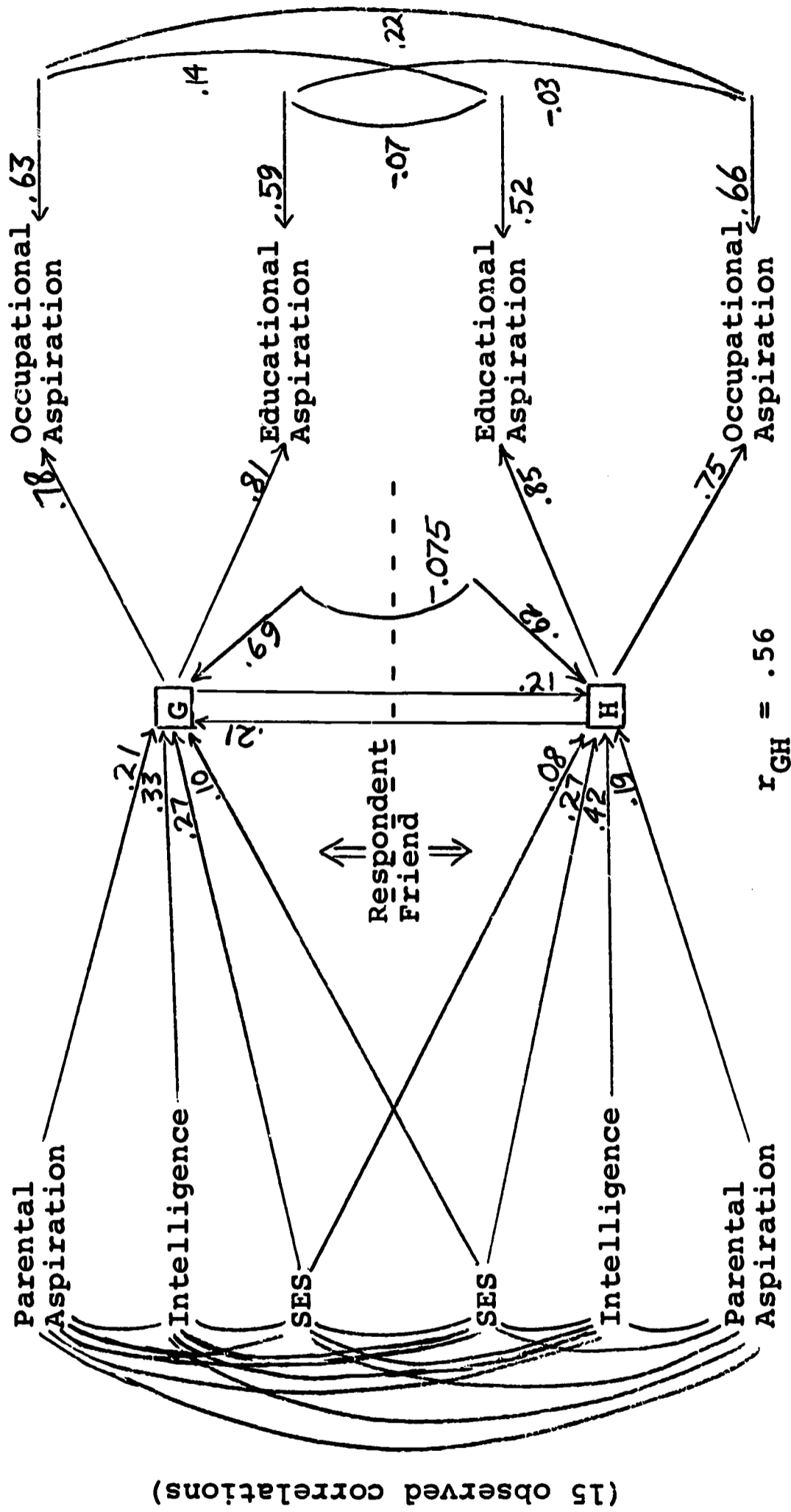

Figure 8.3.1.--Aspirations of Respondents and Best Friends Related to Family Background, Parental Aspiration, and Friend's Aspirations.  
 (Source: Report #7, based on MICH data set.)

by procedures that have some heuristic appeal but not a tight statistical justification.

The results are not without interest, if accepted provisionally for the sake of discussion. Both parental aspiration and friend's motivation bear upon the development of motivation in a boy, and the coefficients suggest they are about equal in importance. This conclusion, however, is somewhat suspect because the data on parental aspiration were obtained from the respondent whereas the data on friend's aspirations were obtained from the friend. The former, therefore, may be subject to an unknown degree of contamination. It is only a coincidence that the two reciprocal paths,  $p_{GH}$  and  $p_{HG}$ , came out equal to the second decimal place, since the format of the data and the technique of estimation did not force such an equality. There are some differences in the paths to H and the corresponding paths to G which may reflect the fact that the friendship used to pair the reports of respondents was identified only by the respondent's choice of "best friend," a choice which was not necessarily reciprocated.

Perhaps the most interesting feature of the model is the perspective that it puts on peer influences. Sociologists have made much of "youth culture," "school climates," and the like; and one sometimes has the impression that socialization to the norms and expectations of peers is all powerful, obliterating the effects of family background and parental influences. This does not appear to be true. There is a modest reciprocal influence or positive feedback that tends to produce homophily with respect to aspirations (or the hypothetical underlying motives assumed to be reflected therein). But the more basic source of such homophily is that lads tend to become associated with others resembling them in socioeconomic background and mental ability.

#### 8.4. Peers and Schools

A sizeable literature of recent years (e.g., Sexton, 1961; Rogoff, 1961; Herriott and St. John, 1966) has pointed out ostensible "school effects," "contextual effects," or "school climates" as influences on achievements and aspirations of youth. In some of this work, investigators have been content to exhibit differences in means of pupil characteristics between schools, classifying the latter on some measure of their social characteristics. In the more detailed studies, however, there has been an effort to separate the effects of school characteristics from the effects of the characteristics of individual pupils themselves (Wilson, 1959; Turner, 1964; Sewell and Armer, 1966).

Whether "school effects" are indexed by the gross association between school characteristics and educational outcomes or by some measure of the net association of the two, holding constant personal and family characteristics of the pupils, the interpretation is seldom governed by an explicit model which represents at once the several presumed sources of variation in achievement or aspiration. The need for

such a model is made quite obvious by an encounter with the hypothesis that "structural effects of school status are best conceived of as due to the interpersonal influences of an individual's significant others" (Campbell and Alexander, 1965, p. 288). These investigators (see also Alexander and Campbell, 1964), in effect, have sought to erect a bridge between studies of "school effects" like those mentioned above and studies in which "peer influences" are scrutinized directly (e.g., Haller and Butterworth, 1960; Simpson, 1962). Our intention here is to suggest that this kind of effort is facilitated by systematic extensions of the models treated in this project.

The first such extension is accomplished by means of the algebraic theorems underlying analysis of covariance. Suppose  $Y_{ij}$  denotes the score of the  $i$ th boy in the  $j$ th school on some measure of educational aspiration, where  $i = 1, \dots, n_j$  and  $j = 1, \dots, m$ . We define

$$\bar{Y}_j = \sum_i Y_{ij} / n_j, \bar{Y} = \sum_j \sum_i Y_{ij} / \sum_j n_j, \text{ and } y_{ij} = Y_{ij} - \bar{Y}_j$$

(the deviation of the given boy's score from the mean score for his school). Let analogous definitions be given for a variable  $X$ , where  $X_{ij}$  is (say) the family socioeconomic status score for the  $i$ th boy in the  $j$ th school. The usual correlation between  $Y$  and  $X$ , computed without regard to the classification by schools, will be referred to as the "total" correlation and written  $r_{Y_{ij}X_{ij}}$ . Now, suppose each boy is assigned one  $Y$ -score which is  $Y_{ij}$  equal to the mean for his school, i.e.,  $\bar{Y}_j$ , and another which is his own score,  $Y_{ij}$ . If we compute the correlation, over individual boys, between these two scores (denote it  $r_{y_{ij}\bar{Y}_j}$ ), we will have computed, in effect, the correlation ratio of  $Y$ -scores on school, a better known formula for which is the square root of the proportion of the total sum of squares of  $Y$  that lies between schools,

$$\left[ \frac{\sum_j n_j (\bar{Y}_j - \bar{Y})^2}{\sum_j \sum_i (Y_{ij} - \bar{Y})^2} \right]^{\frac{1}{2}}$$

It is useful to note that  $r_{y_{ij}\bar{Y}_j} = 0$  identically and that

$$r_{Y_{ij}y_{ij}} = (1 - r_{Y_{ij}\bar{Y}_j}^2)^{\frac{1}{2}}.$$

The latter is, in fact, the square root of the proportion of the total sum of squares of  $Y$  that lies within schools, i.e.,

$$\left[ \frac{\sum_j \sum_i (Y_{ij} - \bar{Y}_j)^2}{\sum_j \sum_i (Y_{ij} - \bar{Y})^2} \right]^{\frac{1}{2}}$$



Similar definitions can be given, of course, for variable X. Moreover, we can define the "average within-school" correlation of Y and X as  $r_{y_{ij}x_{ij}}$ , computed from the formula,

$$\frac{\sum_{ji} y_{ij} x_{ij}}{\sqrt{\sum_{ji} y_{ij}^2} \sqrt{\sum_{ji} x_{ij}^2}},$$

and the "between-school" correlation as  $r_{\bar{Y}_j \bar{X}_j}$ , which may be computed as follows:

$$\frac{\sum_j n_j (\bar{Y}_j - \bar{Y})(\bar{X}_j - \bar{X})}{\sqrt{\sum_j n_j (\bar{Y}_j - \bar{Y})^2} \sqrt{\sum_j n_j (\bar{X}_j - \bar{X})^2}}$$

From these definitions there follows a useful identity:

$$r_{Y_{ij}X_{ij}} = r_{y_{ij}x_{ij}} r_{Y_{ij}y_{ij}} r_{X_{ij}x_{ij}} + r_{\bar{Y}_j \bar{X}_j} r_{Y_{ij} \bar{Y}_j} r_{X_{ij} \bar{X}_j}$$

Suppose we regard X as a cause influencing Y. The foregoing decomposition of the total correlation may then be represented by a path diagram like the one shown in Figure 8.4.1. The situation is such that each of the six correlations on the right side of the above equation can be regarded as a path coefficient, if that seems appropriate in terms of one's causal scheme. The validity of the decomposition, however, does not depend on the plausibility of assumptions as to causation.

Several interesting calculations can be made from this diagram. It will be noted that there is no path from  $X_{ij}$  to  $Y_{ij}$ ; but the total correlation of .50 between the two variables is nevertheless implicit in the diagram as the sum of a within-schools component

$$(.9443)(.4465)(.8949) = .38$$

and a between-schools component

$$(.3290)(.8572)(.4462) = .12.$$

The contrast in the size of the two components is already a caution against any tendency to exaggerate the socioeconomic influences on aspirations that work through schools as units.

A second calculation reveals that the total variation in  $Y_{ij}$ , set at 1.0, has components of  $(.9443)^2 = .89$  within schools and  $(.3290)^2 = .11$  between schools. One implication of the latter should be obvious at once. Only one-ninth of the variation in Y lies between schools (in the particular population studied here). Hence, no matter

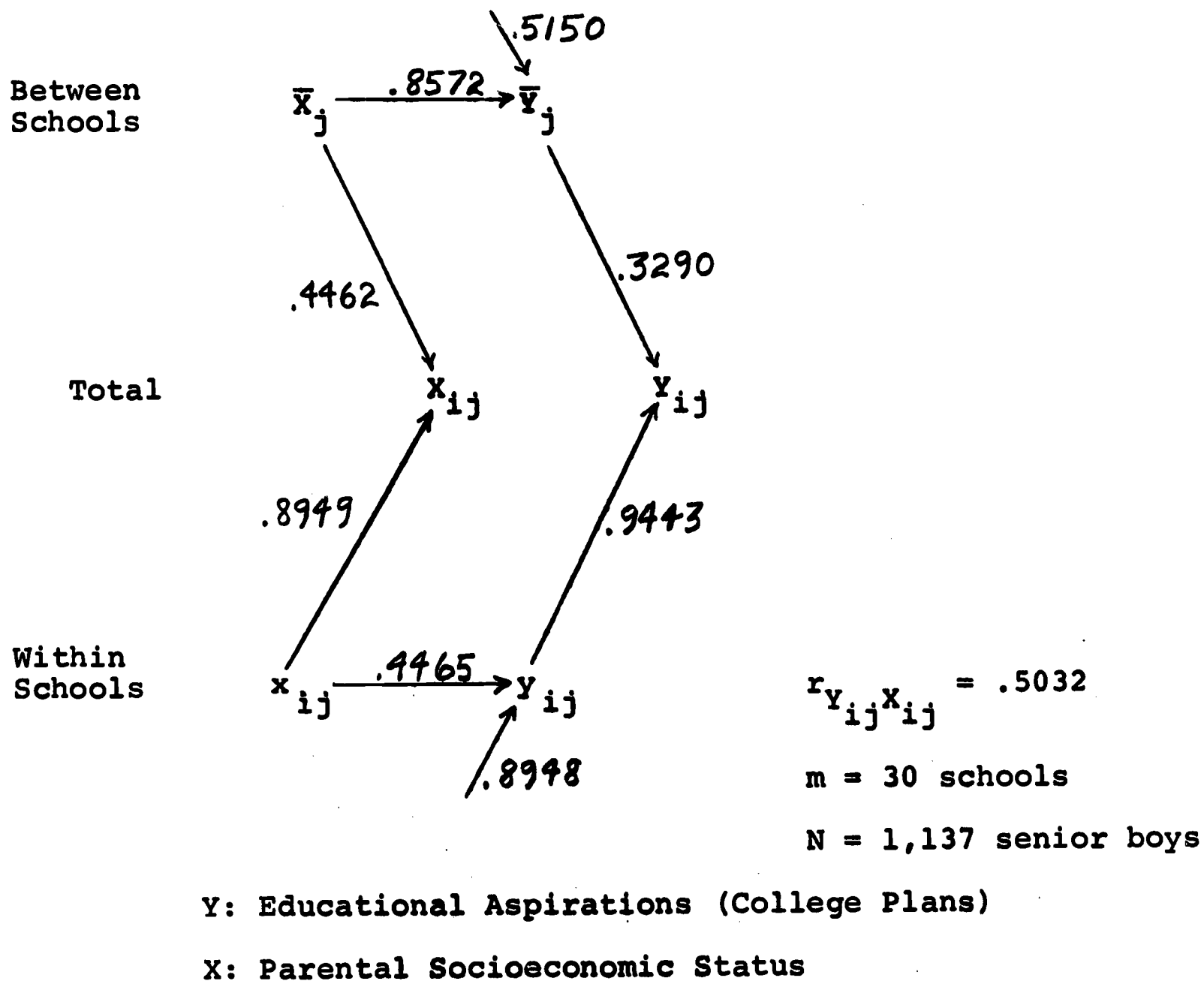

Figure 8.4.1.--Causal Interpretation of the Within-School and Between-School Components of the Correlation between Educational Aspirations and Parental Socioeconomic Status in Unpublished Data of Campbell and Alexander.

how many measurements are made on school composition, school "climate," school "norms and values," school "inputs," and the like, no combination of such characteristics of schools as units can ever "explain" more than one-ninth of the variance in  $Y$ . Again, we are well advised to entertain modest expectations for explanations couched in terms of "school effects," rhetoric (e.g., Sexton, 1961) to the contrary notwithstanding.

It is useful to note that the decomposition of the total correlation involves only four independent quantities, since

$$r_{Y_{ij}y_{ij}}^2 = 1 - r_{Y_{ij}\bar{Y}_j}^2 \quad \text{and} \quad r_{X_{ij}x_{ij}}^2 = 1 - r_{X_{ij}\bar{X}_j}^2 .$$

If the total correlation and three of these quantities are given, it is, of course, possible to solve for the fourth. In particular, given the total and between-school correlations and the two correlation ratios,

$$r_{Y_{ij}\bar{Y}_j} \quad \text{and} \quad r_{X_{ij}\bar{X}_j} ,$$

the average within-school correlation may be obtained from a simple calculation. It was possible to take advantage of this fact in working with the WISC data set. The investigators had assigned certain school means as scores for individuals and the correlation matrix involving such variables, therefore, provided the requisite information for computing average within-school correlations.

In the analysis of covariance there is a procedure termed "adjusting  $Y$ -means for  $X$ ." The null hypothesis is that all the variation in  $\bar{Y}_j$  is due to differences between schools in  $\bar{X}_j$ , given that  $Y$  depends on  $X$  within schools to the extent indicated by the "average within-school" regression coefficient, which is defined as

$$b_w = \frac{\sum_j \sum_i y_{ij} x_{ij}}{\sum_j \sum_i x_{ij}^2} .$$

This procedure suggests the possibility of a decomposition of  $\bar{Y}_j$  into two components, writing  $\bar{Y}_j = \tilde{Y}_j + Y_j^*$ , where  $\tilde{Y}_j = b_w(\bar{X}_j - \bar{X})$  and  $Y_j^*$  (the "adjusted mean") =  $\bar{Y}_j - \tilde{Y}_j$ . Since variation in  $\tilde{Y}_j$  is due solely to variation in  $\bar{X}_j$ , this term may be said to represent the component reflecting  $X$ -composition of schools. Then  $Y_j^*$  is a component reflecting factors other than  $X$ -composition. It is important to note that  $\tilde{Y}_j$  and  $Y_j^*$  are not, in general, uncorrelated. Indeed, in practice, they are often so highly colinear that interpretation is difficult. Another way of putting the matter, if a causal phraseology is allowed, is that  $\bar{X}_j$  affects  $\bar{Y}_j$  both in terms of the  $X$ -composition of schools and via a path involving influences other than composition.

A diagram representing such an interpretation is shown as Figure 8.4.2. Except for the additional detail in the between-school segment, this is the same as Figure 8.4.1. To secure this detail, we must have

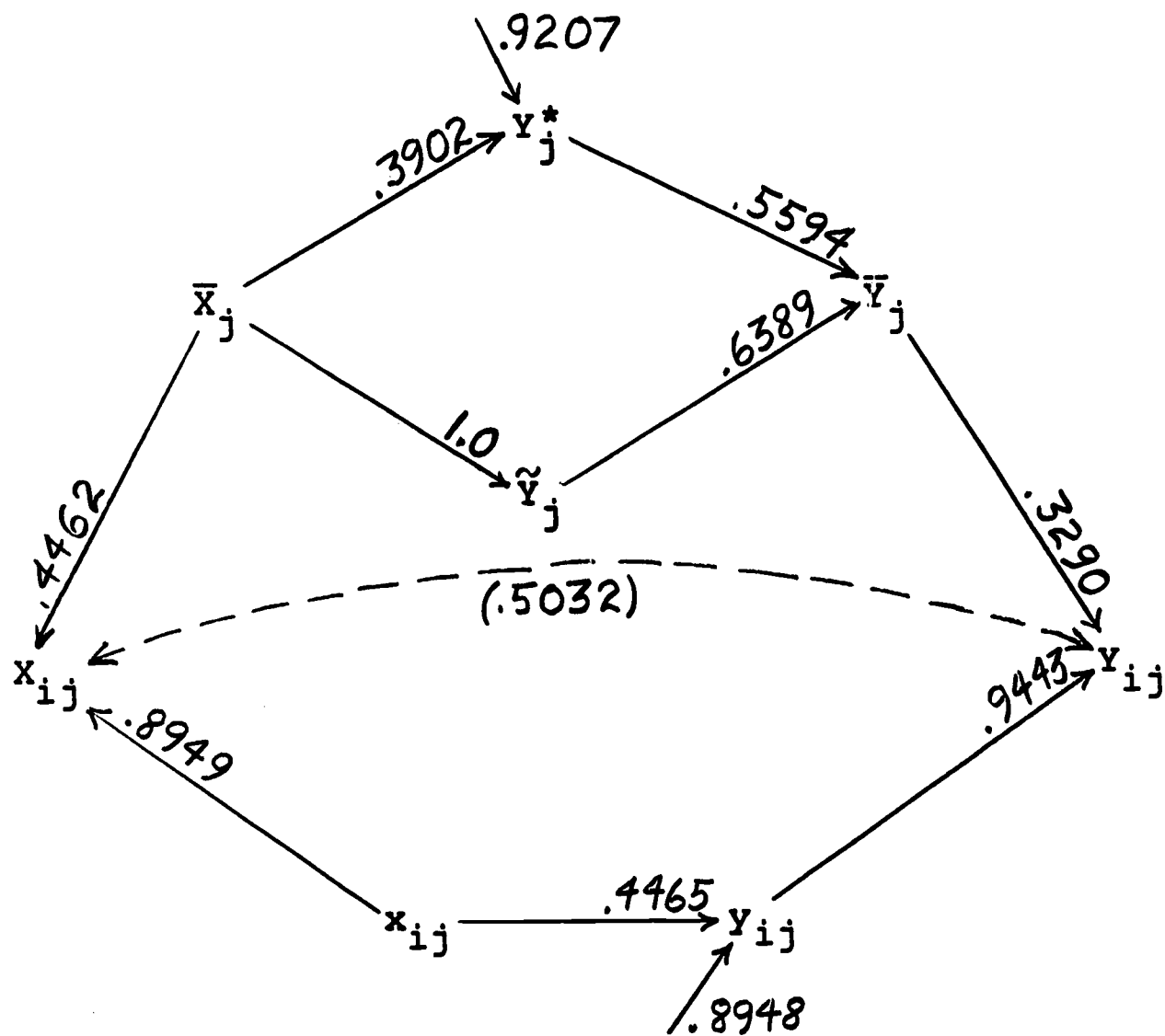

Figure 8.4.2.--Data of Figure 8.4.1 with Between-School Variation in Y Due to X Allocated to Compositional ( $\tilde{Y}_j$ ) and non-Compositional ( $Y_j^*$ ) Components. (Correlation depicted by dotted line is implied by the remainder of the diagram.)

the average within-schools regression coefficient,  $b_w$ , which was defined above. It should be noted that this statistic cannot be computed from a correlation matrix alone, even one that includes within- and between-school correlations. It must be obtained as part of an analysis-of-covariance computing routine. The necessary data for its calculation were kindly made available by Professors Campbell and Alexander.

We have defined components  $\tilde{Y}_j$  and  $Y_j^*$  such that  $\bar{Y}_j$  is completely determined by their sum. These quantities are in raw score form. Path coefficients are defined by considering their relationship in standard form; we obtain

$$\frac{\bar{Y}_j - \bar{Y}}{\text{s.d.}(\bar{Y}_j)} = p_{\bar{Y}_j \tilde{Y}_j} \frac{\tilde{Y}_j - M(\tilde{Y}_j)}{\text{s.d.}(\tilde{Y}_j)} + p_{\bar{Y}_j Y_j^*} \frac{Y_j^* - M(Y_j^*)}{\text{s.d.}(Y_j^*)}$$

where  $p_{\bar{Y}_j \tilde{Y}_j} = \text{s.d.}(\tilde{Y}_j) / \text{s.d.}(\bar{Y}_j)$  and  $p_{\bar{Y}_j Y_j^*} = \text{s.d.}(Y_j^*) / \text{s.d.}(\bar{Y}_j)$ ,

using  $M(\ )$  to denote "mean of" and  $\text{s.d.}(\ )$  to denote "standard deviation of." The first of the two path coefficients is easily computed, for  $\text{s.d.}(\tilde{Y}_j) = b_w[\text{s.d.}(\bar{X}_j)]$  and  $\text{s.d.}(\bar{Y}_j)$  is defined in terms of between-school sum of squares of  $Y$ . Hence,

$$p_{\bar{Y}_j \tilde{Y}_j} = b_w \left[ \frac{\sum_j n_j (\bar{X}_j - \bar{X})^2}{\sum_j n_j (\bar{Y}_j - \bar{Y})^2} \right]^{\frac{1}{2}}$$

In the data at hand, this works out at  $p_{\bar{Y}_j \tilde{Y}_j} = .6389$ .

We also have some further information: the complete determination of  $\bar{Y}_j$  by its two components; the path coefficient and correlation,  $p_{\tilde{Y}_j \bar{X}_j}$  and  $r_{\tilde{Y}_j \bar{X}_j}$ , both set at unity; and the value of  $r_{\bar{Y}_j \bar{X}_j}$

(the between-schools correlation already computed). To simplify notation, let  $\bar{Y}_j$  be variable 1,  $\tilde{Y}_j$  be variable 2,  $Y_j^*$  be variable 3, and  $\bar{X}_j$  be variable 4. Let unknown paths be denoted  $p_{13} = g$  and  $p_{34} = h$ . We now know  $p_{12} = .6389$ ,  $p_{24} = 1.0$ , and  $r_{14} = .8572$ . Theorems on path coefficients allow us to write

$$\begin{aligned} r_{14} &= gh + (1.0)p_{12} \\ r_{11} &= 1 = g^2 + p_{12}^2 + 2p_{12}gh. \end{aligned}$$

The solutions are  $g^2 = 1 + p_{12}^2 - 2p_{12}r_{14}$  and  $h = (r_{14} - p_{12})/g$ . From

the data at hand we find  $g = .5594$  and  $h = .3902$ . The residual for variable 3 (or  $Y_j^*$ ) is, of course,  $\sqrt{1 - h^2} = .9207$ .

If the reader prefers, he may regard all this exercise with path coefficients as a means of partitioning variance in  $Y_{ij}$ . We began with the within- and between-school components, summing to unity, which are, respectively (as already noted),  $(.9443)^2 = .8917$  and  $(.3290)^2 = .1082$ . The within-school portion has two components of its own, that due to regression on  $X$ , which is  $(.4465)^2 = .1994$ , and the residual  $(.8948)^2 = .8007$ . To express these as proportions of total variance, each must be multiplied by  $.8917$ .

Partitioning of the between-school variance is messier. First (as in Figure 8.4.2) we break out the part that is uncorrelated with  $\bar{X}_j$ :  $[(.5594)(.9207)]^2 = (.5150)^2 = .2652$ . This leaves the part due to correlation of  $\bar{Y}_j$  with  $\bar{X}_j$  as  $(.8572)^2 = .7348$ . But the purpose of our somewhat formalistic procedures was precisely to indicate that the latter is not correctly regarded, in causal terms, as all of a piece. The upper part of the diagram in Figure 8.4.2 tells us that

$$r_{\bar{Y}_j, \bar{X}_j} = .8572 = .6389 + (.5594)(.3902).$$

Squaring both sides we have

$$.7348 = (.6389)^2 + [(.5594)(.3902)]^2 + 2(.6389)(.5594)(.3902).$$

Thus the variance due to  $\bar{X}_j$  may be broken down into  $.4082$  due to the "pure effect" of  $X$ -composition,  $.0476$  due to the between-school operation of  $X$  other than in terms of composition, and  $.2789$  due to the correlation of the two arising from the fact that  $X$  is the ultimate source of both. All the fractions of variance obtained in this paragraph must be multiplied by  $.1082$  if they are to be converted to proportions of total variance in  $Y_{ij}$ .

We may summarize our results in the following tabulation:

Total variance of $Y_{ij}$	1.0
1. Within schools	.8917
(a) Regression on $X$	.1778
(b) Residual	.7140
2. Between schools	.1082
(a) $X$ -composition	.0442
(b) Other effects of $X$	.0052
(c) Joint effects of (a) and (b)	.0302
(d) Residual	.0287

If one chooses to regard the magnitude of residual factors as an indication of the importance of causes as yet unknown, it would seem obvious that much more is to be learned about sources of variation within schools, while there is a comparatively small incremental payoff even for securing a complete accounting for variation between schools.

It is tempting to consider alternative consolidations of the foregoing components in the light of emphasis on the fact that "school districting tends to segregate youths of different social strata" (Wilson, 1959, p. 837). The allusion to a process of "derivation of values from the immediate school milieu" (p. 836) is evidently intended to refer to differences that do not merely reflect the direct operation of socioeconomic factors in such a way that "modally different attitudes" of "school populations" (p. 837) are merely the outcome of differences in socioeconomic composition. It seems relevant, therefore, to sum components 1(a) and 2(a), obtaining  $.1778 + .0442 = .2220$  as the proportion of variance in educational aspirations due to socioeconomic status within schools and sheer compositional differences between schools. This leaves components 2(b) plus 2(c), or  $.0052 + .0302 = .0354$ , as the proportion that one might take as an estimate of effect of "the climate of the school society" (p. 836). This is no negligible figure, of course. On the other hand, schools differ in composition on factors other than socioeconomic status, and the Campbell-Alexander data do not permit an evaluation of the degree to which such other compositional factors may be masquerading as "school climates."

In the remainder of this section we shall not retain the foregoing elaboration of the between-school sector of the model. The requisite information for these calculations is not available in the WISC data set. Moreover, the implications of this procedure are far from obvious. Fortunately, the whole matter is being thoroughly studied in the dissertation of Robert M. Hauser (see Appendix A).

Returning to the simpler (though less informative) point of view on between-school effects represented by Figure 8.4.1, we now bring into the picture data on the respondent's first choice in answer to the question, "What students here in school of your own sex do you go around with most often?" (Campbell and Alexander, 1965, pp. 286-287). For both respondent and best friend, the investigators ascertained information on two variables of interest here: educational aspiration (plans to attend college); and family socioeconomic status (a composite score derived from mother's and father's educational attainment). Thus, we can construct a diagram for friends like the diagram for respondents in Figure 8.4.1. Moreover, correlations between characteristics of respondents and characteristics of friends can be indicated when the two diagrams are juxtaposed. These two steps are carried out in Figure 8.4.3. The prime symbol, as in  $X'_j$ , indicates that the variable pertains to the friend. This diagram does not make explicit any such causal assumption as  $X \rightarrow Y$ . While this particular assumption is attractive, there is little or no basis for either of the assumptions  $X \rightarrow X'$  or  $X' \rightarrow X$ . Without such assumptions, the deductions we can draw from the diagram are somewhat limited, but nonetheless instructive.

One property of the diagram is significant in view of the emphasis of Wilson (1959, p. 845), on schools as providing "unequal moral climates" owing to "concentrations of social classes." Let us compute the correlation between the aspirations of friends that arises from

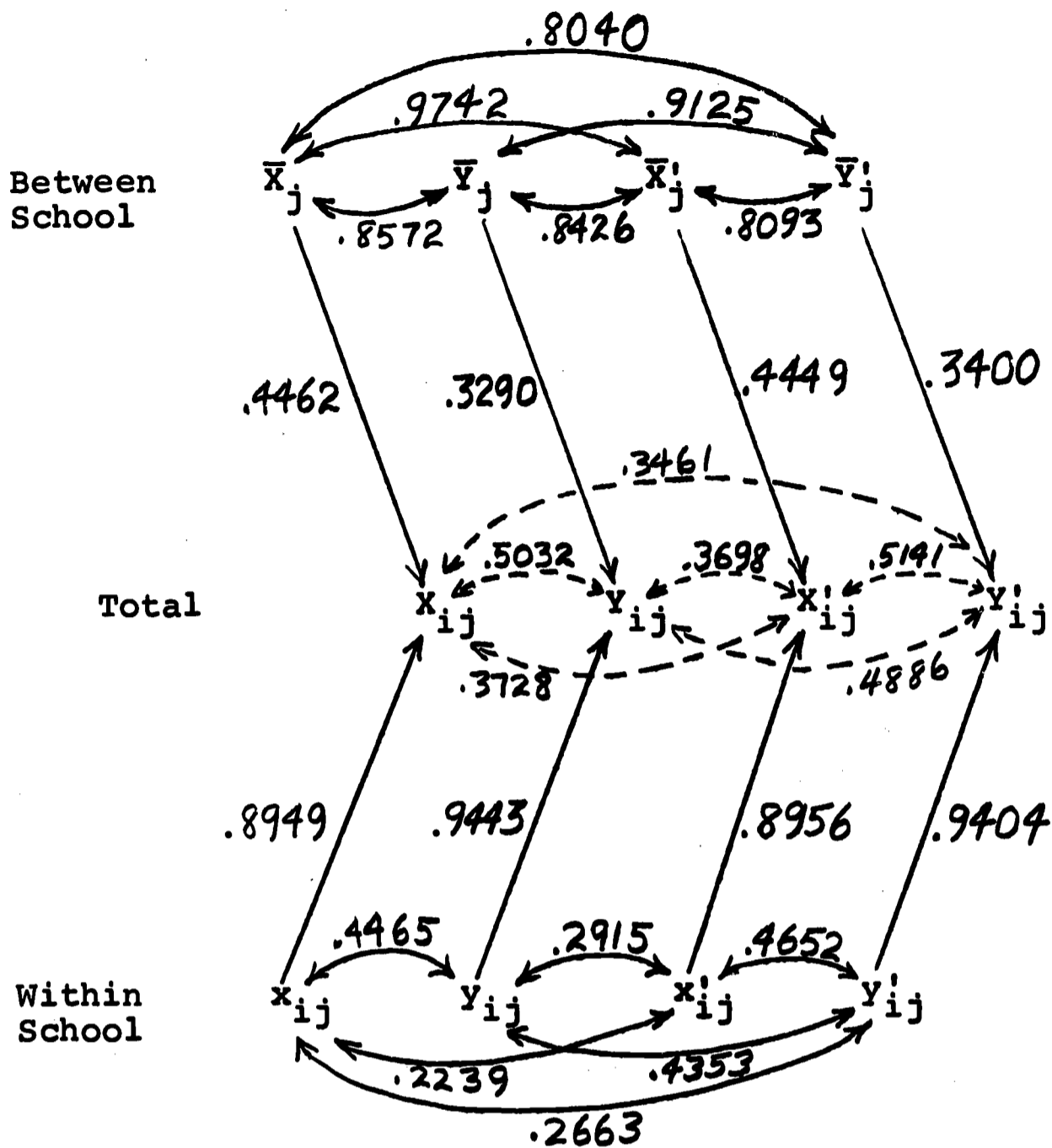

Figure 8.4.3.--Total, Between-School, and Within-School Correlations for Respondents' and Friends' Educational Aspirations (Y) and Socioeconomic Status (X), Computed from Data of Alexander and Campbell. (Correlations depicted by dotted lines are implied by remainder of diagram.)



their attendance at the same school. Suppose from a whole population of respondents and friends pairs were formed at random within each school. Given the between-school components of sums of squares of  $Y_{ij}$  and  $Y'_{ij}$  in the population studied by Campbell and Alexander, we can compute, on this null hypothesis, what the correlation between friends would be. The appropriate calculation is

$$P_{Y_{ij}\bar{Y}_j} r_{\bar{Y}_j\bar{Y}'_j} P_{Y'_{ij}\bar{Y}'_j} = (.3290)(.9125)(.3400) = .1021,$$

according to the data in Figure 8.4.3. By contrast, the within-school correlation ( $r_{y_{ij}y'_{ij}}$ ) is .4353 and the actual total correlation is .4886. If "unequal moral climates" refers to the variation in aspirations of boys going to different schools, we can infer from these results that factors producing homophily with respect to aspirations other than moral climates are much more important in the aggregate than are moral climates per se.

If, on the argument of section 8.3, we think of homophily in regard to SES as possibly giving rise to homophily with respect to aspirations, then it is of interest to learn to what extent "concentrations of social classes" (Wilson, 1959, p. 845) can be held responsible for the former. [This topic was systematically considered by Rhodes, Reiss, and Duncan (1965).] On the null hypothesis suggested above--friendships formed by random choice within schools--we compute the implied correlation of SES scores:

$$P_{X_{ij}\bar{X}_j} r_{\bar{X}_j\bar{X}'_j} P_{X'_{ij}\bar{X}'_j} = (.4462)(.9742)(.4449) = .1934,$$

according to the data in Figure 8.4.3. Hence if SES homophily is productive of homophily in regard to aspirations, it is pertinent that the extent of the former within schools, as indicated by  $r_{x_{ij}x'_{ij}} = .2239$ , is somewhat larger than that produced solely by between-school variation in SES, .1934.

Interesting as all these observations may be, they do not come to grips with our problem in its full complexity. In section 8.3 we suggested a model that represents more or less effectively our ideas about "peer influences"; the data pertained to lads in a single school district and, therefore, were tantamount to information for the "within-school" sector of a model to be applied to a broader population. Since the MICH data set does not supply between-school data, we have resorted to a merger of the WISC and MICH data sets. The former provides between-school data and a portion of the needed within-school data. To fill in the gaps, certain items are borrowed from the MICH data set (see Table 8.4.1). Moreover, some simplifying assumptions are required. We assume identity of the school means for respondents and friends, i.e.,

$$\bar{Y}'_j = \bar{Y}_j, \bar{X}'_j = \bar{X}_j, \text{ and } \bar{Z}'_j = \bar{Z}_j.$$

Or, if one prefers to state it differently, we assume

$$r_{\bar{Y}_j \bar{Y}_j} = r_{\bar{X}_j \bar{X}_j} = r_{\bar{Z}_j \bar{Z}_j} = 1.0;$$

and  $r_{Y_{ij} \bar{Y}_j} = r_{Y_{ij} \bar{Y}_j}$ ,  $r_{X_{ij} \bar{X}_j} = r_{X_{ij} \bar{X}_j}$ , and  $r_{Z_{ij} \bar{Z}_j} = r_{Z_{ij} \bar{Z}_j}$ .

That these assumptions are not too far from the truth is suggested by data in Figure 8.4.3. In fact, we can compute both  $r_{Y_{ij} \bar{Y}_j}$  and  $r_{Y_{ij} \bar{Y}_j}$  for the WISC population; they are .3448 and .3327 respectively (cf. the corresponding values of .3290 and .3400 in the data of Campbell and Alexander).

Another simplification is compatible with the foregoing. This is the procedure of estimating data for friends in such a way that the data become symmetrical in respondent and friend. If all friendship choices were reciprocated and each respondent had just one friend, the observations would, of course, take a symmetrical form. Where this constraint is lacking, the MICH data and those of Campbell and Alexander show some appreciable departures from symmetry. The assumption of symmetry in the present case is merely a heuristic device to allow us to make some interpretation of the WISC data on a model of peer influences within schools.

In the WISC data, information on friends' educational aspirations derives from a question to respondents, phrased: "Most of my friends are: \_\_\_going to college; \_\_\_getting jobs; \_\_\_going into military service; \_\_\_other." It might seem a priori likely that the format of the question together with reliance on the respondent's perception rather than the friend's independent report would tend to exaggerate the correlation between respondents' and friends' educational aspirations. Indeed,  $r_{y_{ij} y'_{ij}} = .4347$  in the WISC data as compared with only .3669 in the MICH  $y_{ij} y'_{ij}$  data. However, this within-school correlation is .4353 in the data of Campbell and Alexander, where respondent's and friend's college plans were independently ascertained. The factor of perceptual distortion, therefore, does not seem serious.

The discrepancy between the WISC and MICH correlations just mentioned is actually a relatively extreme one, as a comparison of the two columns of Table 8.4.1 will reveal. The risks incurred in a merger of the two sets seem relatively minor.

The model for the within-school sector in Figure 8.4.4 is the same in form as one shown in Report #7, where the MICH data were used with quite similar results. It is a simplified version of the model shown in Figure 8.3.1 and discussed in the previous section. There is some cause for dissatisfaction with this model, arising primarily from the correlation of  $-.42$  between the residuals for  $y_{ij}$  and  $y'_{ij}$  which must be postulated for the remainder of the solution to be consistent. It would appear that this negative correlation, difficult as it is to

Table 8.4.1.--Average Within-School Correlations in WISC and MICH Data Sets

Variables* Correlated	Correlation	
	WISC	MICH
yx	.3871	.4047
y'x'	(.3871) <sup>a</sup>	.4105
y'x	.2807	.3054
yx'	(.2807) <sup>a</sup>	.2407
yz	.4012	.4043
y'z'	(.4012) <sup>a</sup>	.5191
y'z	.2761	.2903
yz'	(.2761) <sup>a</sup>	.2863
xz	.2316	.2220
x'z'	(.2316) <sup>a</sup>	.2950
x'z	[.2082] <sup>b</sup>	.1861 <sup>c</sup>
xz'	[.2082] <sup>b</sup>	.2302 <sup>c</sup>
yy'	.4347	.3669
xx'	[.2707] <sup>b</sup>	.2707
zz'	[.3355] <sup>b</sup>	.3355

\*Deviations of individual scores from school means.

y: educational aspirations;

x: socioeconomic status;

z: intelligence.

Prime (') denotes variable defined for friend.

<sup>a</sup> Assumed same as correlation on line above.

<sup>b</sup> Borrowed from MICH data set.

<sup>c</sup> Correlations averaged for entry into WISC data set.

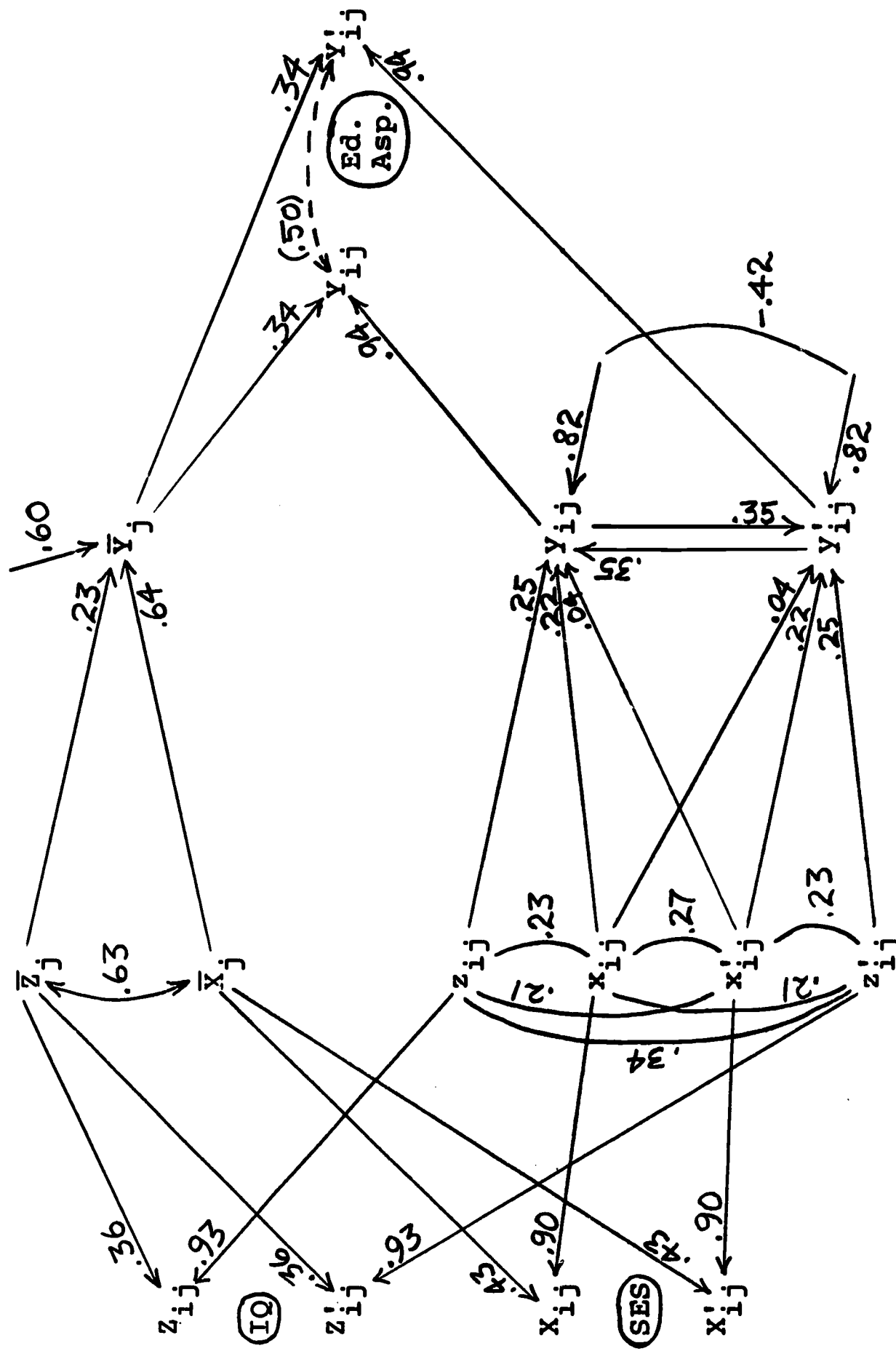

Figure 8.4.4.--Model of Peer Influences and Effects of Intelligence and Socio-economic Status on Educational Aspirations within Schools Combined with Within-School vs. Between-School Decomposition of Correlation between Friends' Aspirations. (Source: Table 8.4.1 and WISC data set.)

rationalize, is in a sense compensating for an exaggeration of the size of the path coefficients running from respondent's to friend's and from friend's to respondent's educational aspiration. The coefficient of .35 here is appreciably larger than the corresponding coefficient of .21 in Figure 8.3.1, where the correlation between residuals, although negative, is quite negligible in size. Another way to put the matter is this: if the correlation between the residuals for  $y$  and  $y'$  in Figure 8.4.4 were to be zero, given the other coefficients in the diagram, the correlation between  $y$  and  $y'$  would have to be as high as .72. If the correlation between residuals were to be positive--a relatively easy situation to rationalize conceptually-- $r_{yy'}$  would be even larger than .72. In Figure 8.3.1, the corresponding correlation (between the constructed variables  $G$  and  $H$ ) was as high as .56. That model not only involved hypothetical variables (of which educational aspirations were regarded as a somewhat fallible indicator); it also contained an additional predetermined variable, parental aspiration, for both respondent and friend. Apparently, the somewhat more elaborate version of the model in Figure 8.3.1 has real advantages over the simplified version in Figure 8.4.4.

Actually, there is no conceptual reason why the model of Figure 8.3.1 could not be used as the within-schools model for Figure 8.4.4. The only reason why this was not attempted is that the WISC data set does not provide information on the within- vs. between-school decomposition of all the correlations required for the former model.

One other feature of the model in Figure 8.4.4 may be useful for evaluating it. The model implies a total correlation between the aspirations of friends of  $r_{y_{ij}y'_{ij}} = .50$ , in agreement with the observed total correlation in the  $y_{ij}y'_{ij}$  WISC data. This agreement is coerced by the estimation procedure used. The model also implies an inter-friend total correlation with respect to intelligence of  $r_{z_{ij}z'_{ij}} = .4237$ . In effect, this correlation is "predicted" by the  $z_{ij}z'_{ij}$  merger of the WISC and MICH data sets. Neither set provides an observed value for this correlation and no other such observation on a population like WISC is available. Finally, the model implies  $r_{x_{ij}x'_{ij}} = .4036$ . This may be compared with the total correlation of  $x_{ij}x'_{ij}$  .3728 between SES of respondent and SES of friend in the data of Campbell and Alexander. The difference is not large enough to arouse suspicion.

## CHAPTER 9

### CAREER CONTINGENCIES

The notion of career contingencies used in this research is that of events, occurring subsequently to the determination of family background, that may have a bearing upon the level of ultimate occupational achievement. Any one of an indefinitely large class of such events might legitimately come under scrutiny on this point of view. A man who undergoes a period of poor health, for example, may thereby be handicapped in his subsequent career. A period of service in the Armed Forces may, according to the particulars of the case, prove advantageous or disadvantageous for future occupational success. Since there are no well-defined limits to this class of variables, there can be no pretense of exhaustive coverage. The career contingencies selected for study here are those on which data happen to be available from the OCG study. These include the status of the first job, the age upon entering that job, the experience of migration, the possibility that a marriage was disrupted, the size of the family of procreation, and the timing of its initiation. In not all cases can these variables be neatly or readily entered into the format required for a formal extension to our basic model. We have, therefore, followed opportunistic strategies in regard to the analysis, leaving various results in a form that might be regarded as preliminary to a more fully developed model. Time constraints as well as analytical complications dictated such strategies in some cases.

#### 9.1. First Job

In the original version of the basic model (Blau and Duncan, 1967), the occupational status of the first job reported by the OCG respondent was treated as an intervening variable, located in a causal chain between educational attainment and occupation as of 1962. The authors noted the problem of ambiguity with respect to the temporal ordering assumed in this arrangement, but the exploration of the implications of such ambiguity was left as a task for this project (see section 9.2). The outcome of this work suggested the advisability of deleting first job from the basic model, to avoid conveying an oversimplified impression of how this particular career contingency actually operates. This is not to suggest that it is an unimportant variable but rather to indicate that a separate treatment is advisable.

Before raising the question of the timing of first job with respect to schooling, we may briefly indicate the degree to which first job status depends on family background and the degree to which it relates to current occupational status. In Table 9.1.1 both current occupational status and the status of the first job are related to the three standard family background variables. The point of the presentation is to compare the two measures of occupational achievement in regard to the relative degrees to which they depend on family background. Actually, there is a great deal of similarity in the two sets of results. Both first job and the current occupation as measured for each of four age groups depend positively on father's education, even more so on father's occupation, and negatively on number of siblings. The degree of dependence on family background, if reduced to the single figure of the coefficient of determination, is much the same whether we are looking at first jobs or current occupations or whether, in regard to the latter, we are looking at results for younger men or those for older men.

The surprising thing about these results is that it apparently makes no appreciable difference at what age or career stage we measure occupational achievement, at least as far as estimating the degree to which achievement depends on family background is concerned. (It does, of course, make a difference in regard to the average level of achievement, since there is a substantial amount of net upward mobility from first job to current occupation as measured for any of the four age groups.) Despite the fact that first job and current occupation depend in much the same way and to much the same degree on family background, they are by no means perfectly correlated with each other. The correlation,  $r_{YW}$ , is as follows: .5783 (for men in the population covered in Table 9.1.1, age 25-34); .4944 (age 35-44); .5123 (age 45-54); and .5054 (age 55-64).

In earlier work there was an effort to reconcile these findings with the assumption that the four age groups may stand for successive observations on a synthetic cohort (Blau and Duncan, 1967, pp. 177-188). The synthetic cohort model was not wholly successful though apparently it had some heuristic utility. Figure 9.1.1 indicates the nature of the difficulty in the synthetic cohort interpretation. In preparing this version of the synthetic-cohort interpretation, we carried out the following steps. The value of  $r_{YW}$  for each cohort was taken to be equal to the average of the four such correlations for the several cohorts. This arbitrary step is not unreasonable, in view of the fact that the four correlations are quite similar; they vary between .545 and .586. Next,  $Y_1$  (occupational status of men 25-34 years old) was regressed on  $W$  and  $U$ . Then it was assumed that occupation at age 25-34 would have a direct effect on occupation at age 35-44, as would educational attainment; but that first job would have only an indirect effect. These assumptions permit us to write the two equations that must be solved to secure estimates of  $p_{21}$  and  $p_{2U}$ :

$$r_{2W} = p_{21}r_{1W} + p_{2U}r_{1U}$$

$$r_{2U} = p_{21}r_{1U} + p_{2U}$$

Table 9.1.1.--Partial Regression Coefficients in Standard Form for Relationships of First Job and Current Occupational Status to Family Background Factors, by Age, for Non-Negro Men with Nonfarm Background, in Experienced Civilian Labor Force: March 1962

Age and Dependent Variable*	Independent Variables*			Coefficient of Determination
	T	X	V	
<u>25-34</u>				
W (First job)	-.1696	.2632	.1405	.187
Y (1962 Occupation)	-.1438	.2263	.1928	.181
<u>35-44</u>				
W	-.1535	.2376	.1696	.185
Y	-.1703	.2842	.1198	.196
<u>45-54</u>				
W	-.1038	.2945	.1404	.179
Y	-.1467	.3126	.0646	.169
<u>55-64</u>				
W	-.1525	.3063	.0971	.189
Y	-.1624	.2486	.1255	.168

\*V: Father's (or family head's) educational attainment  
X: Father's (or family head's) occupational status  
T: Respondent's number of siblings  
W: Status of respondent's first job  
Y: Respondent's occupational status, March 1962

Source: OCG data set.



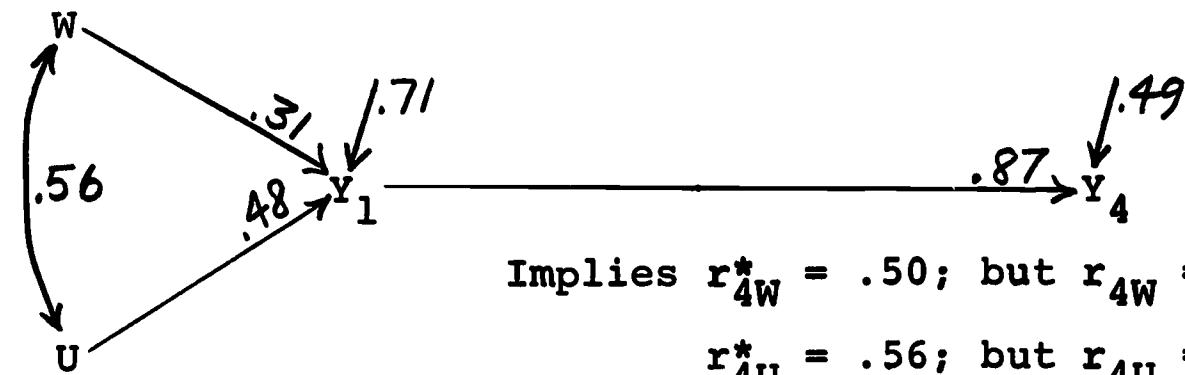
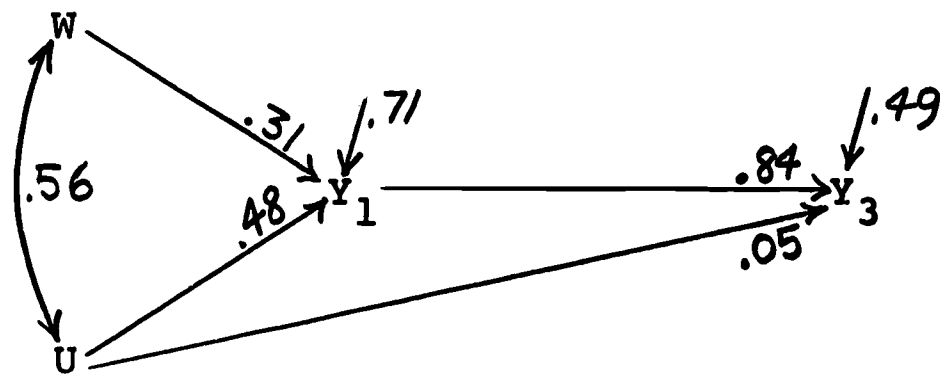
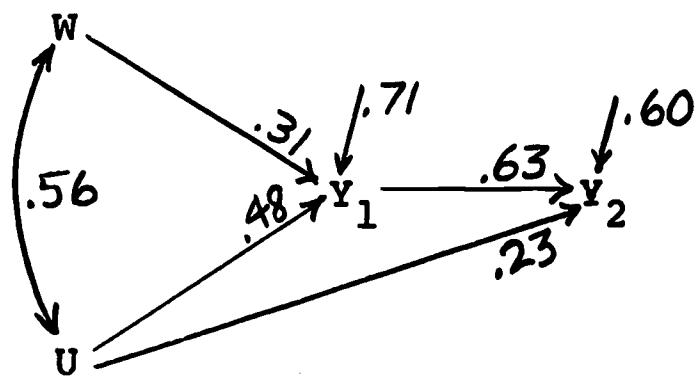

Implies  $r_{4W}^* = .50$ ; but  $r_{4W} = .56$

$r_{4U}^* = .56$ ; but  $r_{4U} = .51$

W: First Job

U: Education

$Y_1 \dots Y_4$ : Occupational Status at Ages 25-34, 35-44, 45-54, 55-64, respectively.

Figure 9.1.1.--Synthetic Cohort Models Based on Combination of Data for Older Cohorts with Those for Men 25-34 Years Old. (See Table 9.1.1 for source and population specifications.)

Note that  $r_{21}$  does not enter into these equations. Inasmuch as  $Y_2$  is related to  $Y_1$  only by the hypothesis that data for the two cohorts may be merged into a synthetic cohort, we do not have an observed value of  $r_{21}$ . However, given the estimated path coefficients obtained from the foregoing equations, we may compute the implied value of this correlation; we obtain

$$r_{21}^* = p_{21} + p_{2U} = .78.$$

While this seems a little high by comparison with the only available estimate of such a correlation (Duncan and Hodge, 1963), it cannot be dismissed as wholly implausible.

Thus far--that is, with the completion of the top diagram in Figure 9.1.1--we have found no internal inconsistency in the synthetic-cohort interpretation. However, when we proceed to the second diagram, securing estimates by an exactly analogous procedure, such an inconsistency does turn up. We obtain  $p_{31} = .84$  and the implied correlation between occupation at age 45-54 and at age 25-34 is  $r_{31}^* = .87$ . Again, while the latter seems a little high, it is not in itself wholly implausible. However, when we note that the path coefficient representing the degree of persistence of occupational status over the life cycle is  $p_{31} = .84$  for a 20-year span while  $p_{21} = .63$  for a 10-year span, it appears that there is real difficulty with any simple version of the synthetic-cohort interpretation. Of course, it is mathematically possible that current occupational status could depend not only on the last previously measured occupation but also on occupations held at various earlier career stages. Thus, one might be tempted to supply an arrow from  $W$  to  $Y_3$  in addition to those already appearing in the second diagram. There are not enough known correlations in the data inspected here to produce estimates for such a diagram. In any event, not a great deal would be proved by the carrying out of such estimates.

When we come to the third diagram, a further difficulty arises. If both  $p_{41}$  and  $p_{4U}$  are included in the diagram and the estimation is carried out with the kind of equations cited above, we secure a small but negative value for  $p_{4U}$ . Since this does not seem reasonable, only the one path to  $Y_4$  is shown and its value is taken to be the average of the values implied by the equations

$$r_{4W} = p_{41}r_{1W} \text{ and } r_{4U} = p_{41}r_{1U}.$$

The two values of  $p_{41}$  are quite close, .874 and .857 respectively. However, the implied correlations of  $Y_4$  with  $W$  and  $U$  indicate that some distortion of the data is entailed by this procedure. Apart from this, however, the more disturbing result is that  $p_{41} = r_{41}$  is higher than either  $p_{31}$  or  $p_{21}$ .

Any of several possible conclusions may now be reasonably entertained. First, it may be that an altered form or a more elaborate version of the synthetic cohort model would yield a satisfactory

interpretation of these data even though the simplified models studied here do not. Some considerable experimentation with various possibilities does not support this conclusion, but it cannot be rejected nonetheless. Second, it may be that the assumption that occupational status persists over time in a simple causal chain pattern is incorrect. This conclusion receives support from the conclusion of Hodge (1966) that intragenerational occupational mobility is not well represented by a simple first-order Markov chain. Third, it may be that the simple version of the synthetic-cohort model exhibited here would afford a fair representation of the data for a real cohort, if such data should exist; but that the actual cohorts studied here have simply not had comparable experiences in regard to their transitions from first jobs to occupations in 1962. The demonstration that these cohorts could not have had identical intragenerational mobility transition matrices at comparable ages (O. D. Duncan, 1965) is in accord with this conclusion, although it is not precisely relevant because the present type of model considers a more complicated process than one merely involving occupational mobility, e.g., in the treatment of education as a predetermined variable of persisting relevance to occupational achievement.

### 9.2. Age at First Job

An apparent inconsistency between the number of grades completed and age at first job in the responses of a sizeable number of men was pointed out in an earlier report on the OCG data (B. Duncan, 1965, Chapter 5). The query on age at first job had taken the form:

Please think about the first full-time job you had after you left school. (Do not count part-time jobs or jobs during school vacation. Do not count military service.) How old were you when you began this job?

The query did not specify "after you last attended a regular school." If schooling proceeded continuously, with the exception of interruption for military service, however, the age at first job would be the age at which the respondent last attended a regular school plus the elapsed time between school-leaving and entry into the employed civilian labor force. A comparison of the "highest grade of school completed" with the "age at first job" for a sizeable number of respondents makes it clear that these men either (a) misreported one or the other item or (b) left school, took a full-time job, and later resumed their schooling. Something over a sixth of the men who report having completed at least a year of graduate study, for example, also report that they had taken their first job before they reached the age of 19.

Only responses to a series of questions on school-leaving and work-force entry could wholly resolve the apparent inconsistency. When did the respondent first leave school for a term or more? When did he most recently attend school? What were his primary activities between periods of school attendance if schooling did not proceed continuously?

The information collected through the OCG survey provides no clues about the sequence of events that occurred, but a check on the internal consistency of the responses can be carried out using information provided by the respondent about the nature of both his first job and the job currently or most recently held.

If "inconsistent" respondents describe as their first job one similar to the first job of a sizeable number of "consistent" respondents who took a job at the reported age and their current job as one similar to the current job of a sizeable number of "consistent" respondents with the reported level of educational attainment, misreporting in the usual sense does not seem a likely explanation of the inconsistency. A more likely explanation is a period of flux between student and worker statuses within which school-leaving and work-force entry cannot be dated unambiguously. An interruption of schooling by full-time participation in the civilian work force or an interruption of job-holding by a resumption of schooling occurred or is perceived to have occurred among inconsistent respondents. Consistent respondents, in contrast, did not experience such interruption or, at least, do not define their experience in this way.

Any attempt to interpret substantively an inconsistency which cannot be shown conclusively to be anything more than an error in reporting is open to question. Nonetheless, the social background and occupational achievement of "inconsistent" respondents may provide clues for investigators who undertake to identify the causes and outcomes of interrupted schooling or "dropouts who came back" in the phrase of Eckland (1964).

Special tabulations of the OCG data were obtained which permit separate analyses of the process of occupational achievement for inconsistent and consistent respondents of like educational attainment. The study population is made up of native civilian non-Negro males whose family head had not been engaged in a farm occupation when the respondent was 16 years old and who were between the ages of 25 and 64 on the 1962 survey date.

Relatively complete reporting of age at first job for the study population was assured at the time the tabulation specifications were designed. (Earlier tabulations showed that only one per cent of the native civilian white males aged 20 to 61 on the survey date who reported a nonfarm occupation for their first job failed to report the age at which they took the job.) Nearly all men in the sample can be assigned to an age-at-first-job stratum (Table 9.2.1). Only among functional illiterates does nonreporting on the item exceed 2.6 per cent, and the nonresponse rate for age at first job is no more than 1.5 per cent in five of the eight strata defined by educational attainment.

Age at first job in relation to grades completed. Given an imagery of grade-mates with a common age, one might expect to find an unambiguous modal age of entry into the civilian work force among men

Table 9.2.1.--Percentage Distribution by Age at First Job for Native Civilian Non-Negro Males Aged 25 to 64 with Nonfarm Background in Eight Strata Defined by Educational Attainment: March 1962

Age at First Job	Grades Completed as of March 1962							
	0-4	5-7	8	9-11	12	13-15	16	17+
All	100.0	100.0	100.0	100.0	100.0	100.0	100.0	100.0
Under 14	14.9	4.9	2.5	1.0	0.4	0.1	0.1	0.2
14	10.9	16.1	8.8	3.4	1.0	0.7	0.2	0.4
15	6.2	10.9	11.0	5.4	2.0	1.6	0.9	1.1
16	20.4	33.0	33.9	28.7	10.2	6.3	4.0	1.7
17	11.2	12.5	18.6	24.8	18.0	13.4	6.1	5.2
18	14.4	9.0	15.4	19.6	32.8	23.0	14.4	8.8
19	9.2	4.1	2.5	5.4	15.8	13.6	6.1	4.5
20	3.5	3.4	1.7	4.9	7.1	11.8	7.8	4.5
21	2.7	1.8	2.2	3.4	5.4	12.0	11.8	9.6
22	1.2	0.7	1.3	1.5	3.1	7.3	14.6	10.1
23	0.2	0.6	0.3	0.6	1.7	3.7	10.5	12.3
24	0.5	0.4	0.4	0.3	0.8	3.2	8.6	12.0
25 and over	4.5	2.5	1.3	1.0	1.8	3.2	14.8	29.6
Nonresponse rate, per 100	6.9	1.7	2.6	1.3	0.8	1.3	0.2	1.5

Source: OCG data set.

whose schooling had terminated at a given grade level. A modal entry age is most pronounced for men who terminated after completing the eighth or twelfth grade, but even for these strata no more than a third of the men report the ages of 16 and 18, respectively. At the other extreme, a seventh of the men who terminated after four years of college report taking their first job at age 18; another seventh report age 22; and still another seventh report an age of 25 or older. The detailed distributions by age at first job within educational-attainment strata appear in Table 9.2.1.

One can only speculate about causes of the diversity in age at entry into the civilian work force among men with similar levels of educational attainment. Periods of civilian employment can intervene between periods of regular school attendance. Military service would have intervened between periods of school attendance, between school-leaving and entry into the civilian work force, or between civilian job-holding and the resumption of schooling for a substantial number of the college-trained men and a lesser number of men with only high-school training. Periods of training in institutions outside the regular school system, such as ungraded business or technical schools, also would intervene between school attendance and civilian job-holding for a sizeable number of men. The tightness of the labor market may influence markedly the time that elapses between school-leaving and employment, especially among the poorly educated whose job skills are few. The survey results make it clear that adult males matched with respect to the amount of formal schooling ultimately completed differ substantially in terms of the age at which they perceive their first regular civilian work-force attachment to have occurred. The potential causes of diversity identified above may alone be sufficient to account for the observed variability although their frequency of occurrence in the study population is unmeasured.

Current and first occupation. Respondents in the study population who reported an age at first job are grouped for analytical purposes into forty strata defined by educational attainment and age at first job. Functional illiterates (men with less than five years of schooling) are treated as a separate stratum without subclassification by age at first job. Respondents in each of the remaining seven categories of educational attainment are subclassified into at least three groups on the basis of age at first job. Each of the forty strata distinguished includes more than a hundred respondents, that is, sample cases. The mean socioeconomic status score of the occupations currently pursued by respondents in each of the forty groups is reported in the upper panel of Table 9.2.2; the mean score for the occupations of their first jobs is reported in the lower panel.

Men in each educational-attainment stratum are rather sharply differentiated from men in any other attainment stratum with respect to the positions they hold in the current occupation structure. Only two instances of overlap with respect to mean current-occupation scores between age-at-first-job groups in adjacent strata of educational

Table 9.2.2.--Mean Socioeconomic Status Score of Occupations Held by Native Civilian Non-Negro Males Aged 25 to 64 with Nonfarm Background in 40 Strata Defined by Age at First Job and Educational Attainment: March 1962

Age at First Job	Grades Completed as of March 1962							
	0-4	5-7	8	9-11	12	13-15	16	17+
	<u>Current occupation</u>							
Under 16		<u>25.95</u>	<u>30.99</u>	<u>32.43</u>	<u>37.62</u>			
16		<u>23.24</u>	<u>25.41</u>	<u>32.11</u>	<u>42.37</u>	<u>47.89</u>	<u>65.53</u>	
17	20.02		<u>25.18</u>	<u>32.96</u>	<u>44.74</u>	<u>55.62</u>		<u>72.72</u>
18				<u>31.01</u>	<u>42.09</u>	<u>53.25</u>	<u>64.54</u>	
19		21.35	27.93	35.25	<u>44.08</u>	<u>55.93</u>		
20					<u>42.20</u>	<u>49.92</u>	<u>69.73</u>	
21					<u>42.46</u>	<u>53.97</u>	<u>70.93</u>	<u>75.27</u>
22				28.67			<u>69.19</u>	
23					40.61	56.12	66.80	76.84
24								
25 and over							<u>67.88</u>	<u>76.97</u>
	<u>First occupation</u>							
Under 16		<u>16.00</u>	<u>16.68</u>	<u>20.95</u>	<u>24.27</u>			
16		<u>15.38</u>	<u>17.94</u>	<u>21.22</u>	<u>23.37</u>	<u>27.57</u>	<u>32.75</u>	
17	11.92		<u>16.38</u>	<u>21.67</u>	<u>27.96</u>	<u>31.20</u>		<u>34.25</u>
18				<u>22.25</u>	<u>27.32</u>	<u>32.47</u>	<u>30.32</u>	
19		17.00	21.24	22.48	<u>30.00</u>	<u>35.89</u>		
20					<u>29.34</u>	<u>37.60</u>	<u>44.62</u>	
21					<u>32.93</u>	<u>41.92</u>	<u>58.13</u>	<u>52.17</u>
22				22.54			<u>55.16</u>	
23					34.07	42.56	57.29	71.04
24								
25 and over							<u>62.96</u>	<u>76.44</u>

Note: Each entry stands for the mean of all cases in the block of cells outlined by horizontal lines and appears opposite the approximate mean age at first job for that group of cells.

attainment are observed: the mean score of men who terminated schooling with the eighth grade and took a job before their sixteenth birthday is slightly higher than the mean score of men who dropped out of high school and deferred taking a job until they had reached their majority; and the mean score of functional literates who completed no more than seven grades and took a job before their sixteenth birthday is slightly higher than the mean score of men who completed the eighth grade and took a job at the age of 16 or 17. Had substantial overlap between strata occurred, the assumption of accurate reporting with respect to educational attainment and/or current occupation would have become untenable; it remains tenable in the absence of overlap.

If one is willing to assume that ability has a modest positive influence on the status of the first job net of schooling completed at the time of work-force entry and that the probability of resuming schooling is associated positively with ability, the assumption of accurate reporting with respect to age at first job remains tenable when the first occupations of respondents are examined. (This assumption also comports with the supposition that men leaving school at a given age are more likely to resume schooling if they are not seriously age-grade retarded at that time.) College graduates who report taking a job at 18, for example, report first jobs with a mean score of 30. Their points of entry into the occupation structure are markedly closer to the entry occupations of high-school graduates who took a job at the age of 18--a mean score of 27--than to the entry occupations of college graduates who took a job at the age of 22--a mean score of 55.

It should be made clear before proceeding further that the foregoing interpretation of the inconsistency between number of grades completed and age at first job, that is, that neither is misreported in the usual sense, is speculative. The patterns described above with respect to current and first occupations can be considered to be compatible with such an interpretation, but they do not validate it. In further discussion, however, it is taken to be the case that respondents are describing accurately their current educational attainment and the age at which they first took a full-time job after leaving school although the salient school-leaving may have been followed by another period of school attendance.

The effects of age at first job net of current educational attainment on the occupation of the first job and on current occupational achievement are displayed graphically in Figure 9.2.1. The interpretation of the net effect of age at first job will differ depending upon whether it is the first or current occupation that is being examined. The amount of schooling completed prior to work-force entry cannot be assumed to be constant within strata defined by current educational attainment. Indeed, there will tend to be a positive association between schooling completed prior to work-force entry and age at work-force entry among men in the same current attainment stratum. Given the floors on age at school entry and age at work-force entry, respectively, the within-stratum association can be presumed stronger among men with



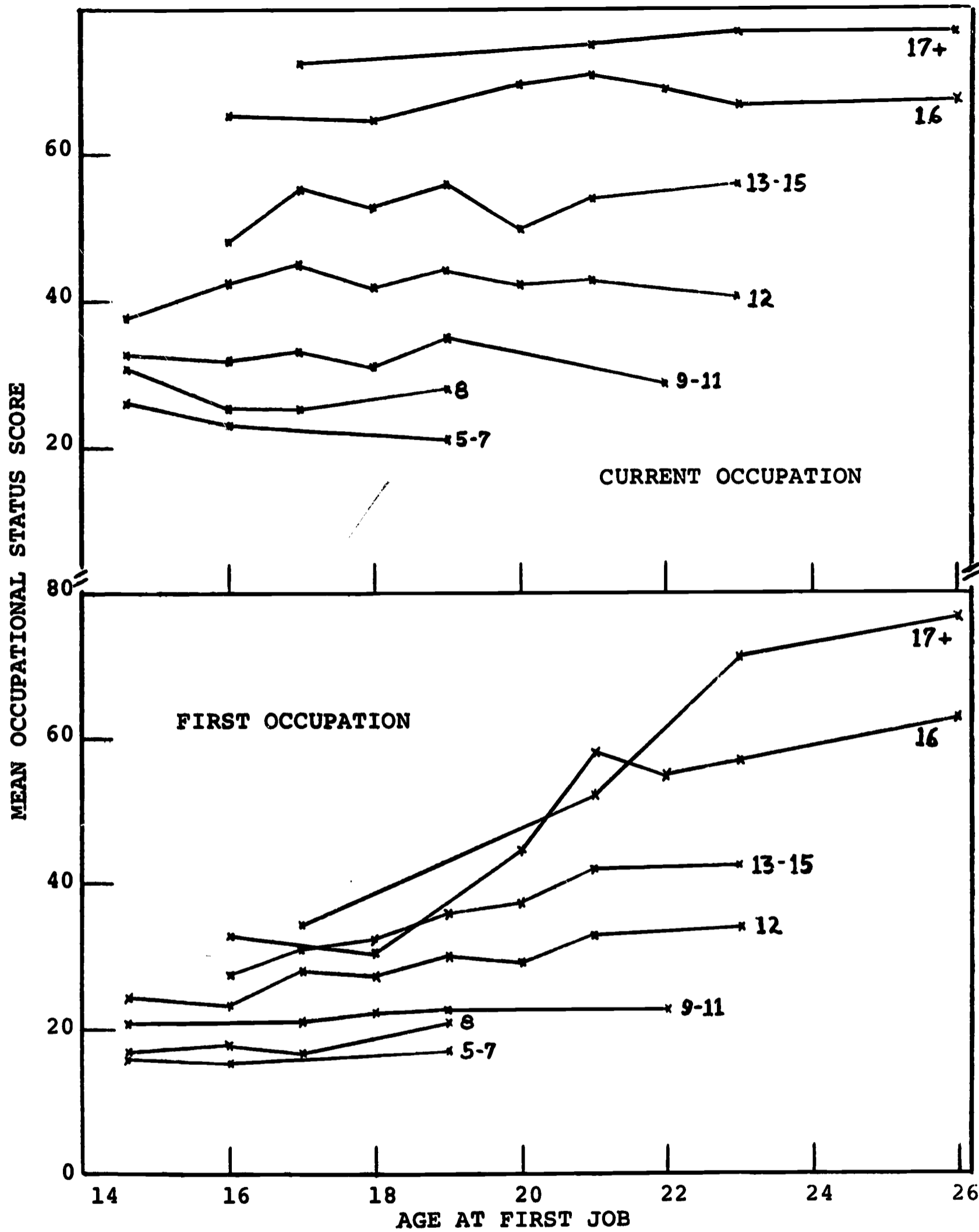

Figure 9.2.1.--Relationships of Mean Status of Current and First Occupations to Age at First Job, within Educational Strata (from Table 9.2.2).

high levels of current educational attainment. Thus, the effects of educational qualification and age per se are confounded in the effects of age at first job on occupation of the first job net of ultimate educational attainment. When it is the current, rather than first, occupation that is being examined, age at first job can be conceived as a past career contingency which may or may not have a long run influence on occupational success independently of present educational qualification.

The net effect of entry age on the status of the entry occupation tends to be positive within each stratum defined by ultimate educational attainment, but the magnitude of the effect becomes notably greater as the level of ultimate educational attainment rises. This we presume to represent a more serious confounding of educational qualification and age per se at the time of job-taking among men of high current educational attainment. In contrast, a positive net effect of age at first job on current occupation is barely detectable among men who have completed at least secondary school and is absent among men with lesser current educational qualification.

It follows directly from these observations that upward mobility from the point of entry into the occupation structure (the mean score for current occupation less the mean score for first occupation) is more pronounced for men who entered the work force at an early age than for men who deferred entry within each stratum defined by educational attainment as of the survey date. (The mean differences in score between first and current occupation are displayed in the upper panel of Table 9.2.3.) This should not be taken to mean that deferral of work-force entry depresses advancement within the occupation structure for men entering the work force with the same amount of formal schooling. Instead, the incremental education acquired after work force entry is thought to result in atypically rapid promotion within the occupation structure.

In fact, for several groups whose age at first job relative to current educational attainment unambiguously implies work-force entry prior to the completion of schooling, the socio-economic status of the current job varies independently of the socio-economic status of the first job. The lower panel of Table 9.2.3 shows the regression coefficient measuring the relation of the score of the current occupation to the score of the first occupation for men in the forty strata defined by educational attainment and age at first job. For most strata the positive sign and substantial magnitude of the coefficient suggest an appreciable degree of continuity in career subsequent to work-force entry. No such continuity characterizes the work history of men who were civilian job-holders before they completed college, however.

Social background. Within educational-attainment strata, early job-taking is associated with a social background unfavorable to prolonged schooling. Whether the association comes about through differential work-force participation or differential perception of the participation as a full-time job after school-leaving is moot. The possibility

Table 9.2.3.--Relation of Respondent's Current to First Occupation for Native Civilian Non-Negro Males Aged 25 to 64 with Nonfarm Background in 40 Strata Defined by Age at First Job and Educational Attainment: March 1962

Age at First Job	Grades Completed as of March 1962							
	0-4	5-7	8	9-11	12	13-15	16	17+
	<u>Mean increase over first occupation<sup>a</sup></u>							
Under 16		9.95	14.31	11.48	13.35			
16		7.86	7.47	10.89	19.00	20.32	32.78	
17	8.10		8.80	11.29	16.78	24.42		38.47
18				8.76	14.77	20.78	34.22	
19		4.35	6.69	12.77	14.08	20.04		
20					12.86	12.32	25.11	
21					9.53	12.05	12.80	23.10
22				6.13			14.03	
23					6.54	13.56	9.51	5.80
24								
25+							4.92	0.53
	<u>Regression coefficient on first occupation</u>							
Under 16		.167*	.343	.390	.154*			
16		.236	.303	.357	.368	.216	.041*	
17	.658		.167*	.338	.200	.361		-.012*
18				.309	.286	.212	.151*	
19		.541	.425	.334	.428	.245		
20					.447	.318	.076*	
21					.386	.230	.101*	.042*
22				.410			.108	
23					.502	.298	.284	.307
24								
25+							.290	.696

\*Not statistically significant at .05 level.

<sup>a</sup>For men reporting both current and first occupation.

of resuming schooling may seem sufficiently remote to the lower-status male when he accepts civilian employment for the first time that he defines the event as the first job even when it has been followed by another period of school attendance. His higher-status counterpart who anticipates a continuation of schooling may define the event as only a temporary interruption of his student status.

Differences with respect to both the occupation and education of the family head by the respondent's reported age at first job are to be observed among men with the same current level of educational attainment. The mean socioeconomic status score of the occupations pursued by the heads of the families in which young job-takers grew up tends to be lower than the mean score of the occupations pursued by the heads of the families in which older job-takers grew up. The number of grades completed by the family heads also tends to vary directly with reported age at first job within strata defined by current educational attainment. The frequency with which these patterns recur from one attainment stratum to another can be observed in the tabular presentation of Table 9.2.4 or the graphic presentation of Figure 9.2.2.

Within strata defined by educational attainment, and particularly within strata where the level of attainment is high, it is the early job-takers who typically have experienced the greatest upward social mobility over the parental generation. Intergenerational mobility with respect to education can be inferred readily from entries in the lower panel of Table 9.2.4. Mean changes between the socioeconomic status scores of the occupations currently pursued by respondents and the scores of the occupations pursued by their family heads are displayed in the upper panel of Table 9.2.5. Inversions in the asserted inverse relation between the amount of upward intergenerational mobility and the age at first job occur with moderate frequency, but they are not patterned with sufficient regularity to invalidate the general tendency.

The differentials with respect to intergenerational mobility which appear when the current occupational achievement of the respondent is contrasted with the occupational status that had been attained by the family head at the time the respondent was an adolescent develop as the respondent's work career lengthens and he increments the schooling completed prior to work force entry. When the respondent's entry occupation is contrasted with the occupation of his family head, the early job-takers within strata defined by current educational attainment are not distinguished by a relatively favorable position in the occupation structure vis-à-vis the positions of their family heads. In fact, the lower panel of Table 9.2.5 reveals, that they are, if anything, distinguished by a relatively unfavorable position.

Another aspect of social background is tapped by two measures on the respondent's siblings: their number; and the educational attainment of the older brother for respondents who have such a sibling. Mean scores on the respective items appear in Table 9.2.6 for respondents in the forty cells defined by educational attainment and age at first job.

Table 9.2.4.--Mean Socioeconomic Status Score of Occupation and Mean Number of Grades Completed for Family Heads of Native Civilian Non-Negro Males Aged 25 to 64 with Nonfarm Background in 40 Strata Defined by Age at First Job and Educational Attainment: March 1962

Age at First Job	Grades Completed as of March 1962							
	0-4	5-7	8	9-11	12	13-15	16	17+
	<u>Occupation</u>							
Under 16		19.22	21.65	25.12	31.56			
16		20.14	22.04	26.36	31.58	37.66	37.94	
17	17.34		22.38	28.39	31.75	39.09		44.90
18				26.92	33.00	40.54	41.71	
19		21.54	23.54	25.38	33.23	43.69		
20					34.28	50.73	48.60	
21					34.96	42.27	51.14	50.26
22				29.08			52.16	
23					33.61	48.61	53.17	53.06
24								
25+							51.30	53.66
	<u>Education</u>							
Under 16		6.20	6.47	7.40	8.17			
16		6.22	6.64	7.54	7.91	9.54	9.19	
17	5.97		7.29	7.39	8.50	9.54		9.20
18				7.93	8.56	9.51	9.41	
19		6.14	6.93	8.17	8.79	9.96		
20					8.11	11.09	10.27	
21					8.66	10.33	10.92	10.89
22				7.61			11.60	
23					8.62	10.60	11.27	11.09
24								
25+							11.67	11.93

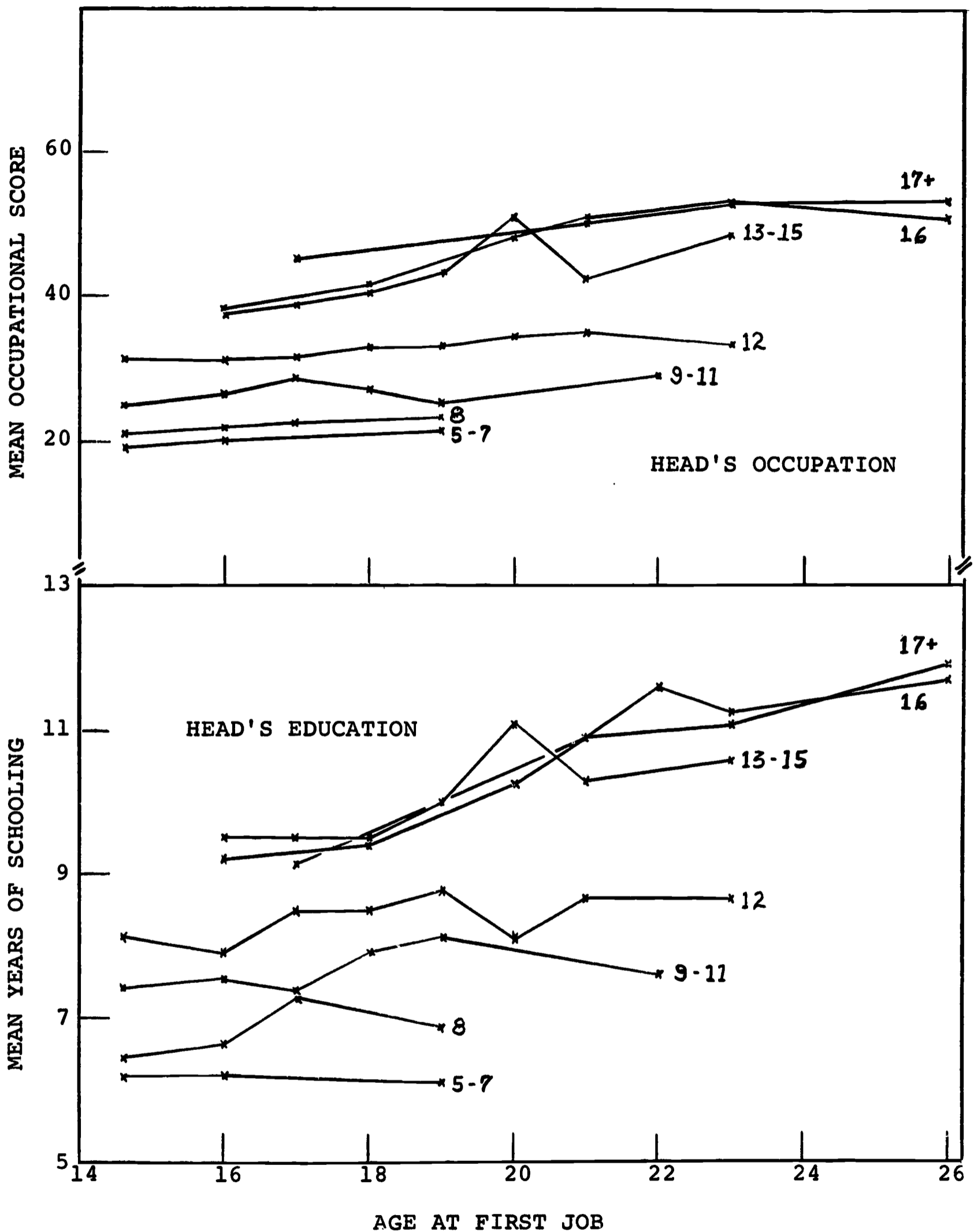

Figure 9.2.2.--Relationships of Mean Occupational Status and Educational Attainment of Heads of Respondents' Families of Orientation to Respondents' Age at First Job, within Educational Strata (from Table 9.2.4).

Table 9.2.5.--Relation of Respondent's Current and First Occupations to Family Head's Occupation for Native Civilian Non-Negro Males Aged 25 to 64 with Nonfarm Background in 40 Strata Defined by Age at First Job and Educational Attainment: March 1962

Age at First Job	Grades completed as of March 1962							
	0-4	5-7	8	9-11	12	13-15	16	17+
	<u>Mean change, current over head's occupation<sup>a</sup></u>							
Under 16		6.51	9.51	7.79	7.49			
16		3.33	4.05	5.96	10.96	9.55	27.74	
17	4.75		2.60	5.06	12.59	17.28		28.44
18				4.33	8.90	14.11	24.19	
19		0.13	4.78	10.22	11.37	12.11		
20					7.85	-0.38	21.75	
21					7.44	11.66	19.52	25.99
22				-1.11			17.75	
23					8.18	7.10	13.43	23.62
24								
25+							16.62	23.22
	<u>Mean change, first over head's occupation<sup>a</sup></u>							
Under 16		-3.14	-4.54	-4.49	-6.78			
16		-4.38	-4.83	-4.96	-8.25	-10.18	-5.21	
17	-4.08		-6.15	-6.36	-4.82	-7.23		-9.70
18				-4.49	-5.79	-6.79	-10.80	
19		-4.36	-1.88	-2.97	-2.64	-8.14		
20					-4.48	-13.41	-4.14	
21					-1.46	0.55	7.02	2.46
22				-7.32			2.83	
23					1.15	-6.28	4.77	17.89
24								
25+							11.73	22.52

<sup>a</sup>For men reporting both occupations.

Table 9.2.6.--Means of Respondent's Number of Siblings and His Oldest Brother's Schooling for Native Civilian Non-Negro Males Aged 25 to 64 with Nonfarm Background in 40 Strata Defined by Age at First Job and Educational Attainment: March 1962

Age at First Job	Grades Completed as of March 1962							
	0-4	5-7	8	9-11	12	13-15	16	17+
	Mean number of siblings							
Under 16		5.30	5.43	4.87	3.81			
16		5.28	5.55	4.48	3.70	3.61	3.48	
17	5.53		5.31	4.18	3.62	3.41		3.20
18				4.42	3.51	3.15	2.69	
19		5.97	5.72	4.35	3.30	2.94		
20					3.44	2.49	2.40	
21					3.28	3.01	2.23	2.73
22				4.38			2.59	
23					3.74	2.71	2.17	2.41
24								
25+							2.47	2.08
	Mean brother's education							
Under 16		7.67	8.23	8.96	12.02 <sup>a</sup>			
16		7.90	9.09	10.07	11.13	11.21 <sup>a</sup>	11.71 <sup>a</sup>	
17	6.74		8.81	10.01	11.13	13.35		13.19 <sup>a</sup>
18				10.17	11.44	12.85	12.86	
19		8.26	9.30	10.18	11.85	12.61		
20					11.84	13.11	14.20 <sup>a</sup>	
21					11.22	13.36 <sup>a</sup>	14.66 <sup>a</sup>	13.96 <sup>a</sup>
22				10.49			14.39 <sup>a</sup>	
23					11.45	13.06	14.54	13.83
24								
25+							13.92	14.45 <sup>a</sup>

<sup>a</sup>Fewer than 60 sample cases.



A relatively small number of siblings and relatively high educational attainment on the part of older brothers are conducive to prolonged schooling. Within most educational-attainment strata, they also tend to be conducive to late entry into the work force. There are noteworthy exceptions, however. Among men whose schooling has not proceeded beyond the elementary level, few, rather than many siblings, distinguish the early job-takers. Among men who terminated schooling with the twelfth grade or some college training, the educational attainment of older brothers is not associated with age at work-force entry.

An overall impression can be formed on the basis of these differentials that elements of the family's structure and status which are conducive to high educational attainment also are conducive to continuity in schooling. The groups of men whose schooling is presumed to have been interrupted by a period of civilian employment, given their current educational attainment and reported age at first job, are drawn disproportionately from families whose characteristics are relatively unfavorable to educational attainment. Inasmuch as these men have achieved occupational success consonant with their ultimate educational attainment, their gains over the occupational status of their family heads have been atypically large.

Several bases of differentiation between "early job-takers" and other respondents with the same level of current educational attainment are summarized in Table 9.2.7. Among the men whose educational attainment as of the survey date was high, a subgroup of early job-takers can be distinguished who must have interrupted their schooling with a period of civilian employment. These early job-takers are defined as men who report completing at least 17 grades and also report on age at first job of 21 or less, and men who report completing 16 grades and also report an age at first job of 20 or less. The early job-takers report first occupations ranking relatively low in the occupation structure; in fact, the difference in mean scores between early job-takers and other respondents amounts to a full standard deviation for the first-occupation scores. The point of primary interest here, however, is differentiation with respect to social background and current occupational success.

Within both educational-attainment strata, the early job-takers report: a relatively low level of educational attainment on the part of the head of the family in which they were reared; an occupation for their family head which has relatively low socio-economic status; a relatively large number of siblings; a relatively low level of educational attainment on the part of their older brother, if they have one; and a relatively young age at marriage, if they have married. Although the early job-takers also have experienced slightly less occupational success than other respondents in the same educational stratum, they are less sharply differentiated from the other respondents with respect to current occupation than with respect to antecedent social characteristics. Among college graduates, for example, the difference in mean scores with respect to current occupation amounts to only a tenth of a standard deviation for current-occupation scores. In contrast, the

Table 9.2.7.--Mean Scores and Standard Deviations on Selected Variables for College Graduates, by Age at First Job, in the Population of Native Civilian Non-Negro Men Aged 25 to 64 with Nonfarm Background: March 1962

Item	Grade 17 or More		Grade 16	
	Early job-takers <sup>a</sup>	All other	Early job-takers <sup>b</sup>	All other
	<u>Mean score</u>			
Family head's--				
Education (V)	10.11	11.47	9.66	11.38
Occupation (X)	47.68	53.33	43.11	52.08
Siblings (T)	2.96	2.26	2.81	2.36
Older brother's education (E)	13.54	14.06	12.92	14.36
Age at marriage (M)	25.04	26.50	24.97	25.19
First occupation (W)	43.53	73.54	36.03	58.33
Current occupation (Y)	74.04	76.90	66.65	68.46
	<u>Standard deviation</u>			
Family head's--				
Education (V)	4.14	4.10	3.69	4.08
Occupation (X)	23.53	23.59	23.10	23.15
Siblings (T)	2.51	2.04	2.36	2.19
Older brother's education (E)	3.28	3.17	3.15	2.88
Age at marriage (M)	4.46	5.52	4.55	3.97
First occupation (W)	23.94	18.39	20.64	21.13
Current occupation (Y)	15.54	14.39	17.60	15.32

<sup>a</sup>Reported an age at first job of 21 or less.

<sup>b</sup>Reported an age at first job of 20 or less.

differences in mean scores with respect to head's education and occupation amount to two-fifths of the respective standard deviations.

Superficially inconsistent reports on the number of grades completed and age at first job appear to distinguish a group of men whose educational attainment and occupational achievement are relatively high given their social background and whose schooling was interrupted by a period of civilian employment. There is perhaps some justification for looking toward the construction of models of the process of occupational achievement which incorporate not only the amount of schooling, but also the timing of schooling within the life cycle.

### 9.3. Migration

Migration is treated as a career contingency in view of the way the phenomenon is ascertained in the OCG data. A "migrant" is a respondent who reports that his present community of residence ("city, town or rural area") differs from the one where he lived at age 16. All other respondents are classified as "nonmigrants." Migration at some unspecified time, therefore, intervenes between characteristics of the family of orientation and occupational status as of the survey date. There is no information as to the timing of migration with respect to the completion of formal schooling. Common knowledge suggests that pursuit of a college--or even, under some circumstances, a secondary--education requires or occasions migration. In such a case, it is probably not accurate to think of either migration or educational attainment as a cause of the other. In other cases, of course, migration does not occur until after schooling is completed, although the bulk of the moves ascertained in the type of inquiry described here probably occur during the late adolescent and young adult years.

The main question we try to answer in this brief analysis is whether the occupational achievements of men are favorably or unfavorably influenced by the experience of migration. This question is not lacking in ambiguity, since whether an experience is "favorable" or not may depend on the selection of a norm of comparison. One possible comparison is that between migrants and nonmigrants in the same communities of origin. If the migrants enjoy greater success than the nonmigrants, it is inferred that the experience of migration has a favorable influence. In this comparison, however, it is difficult to rule out the hypothesis that migrants enjoy an advantage primarily due to participation in a more favorable opportunity structure. This hypothesis can be excluded by adopting the alternative strategy of comparing migrants with nonmigrants in the communities of destination. In this case, the opportunity structures are presumably the same.

Whatever type of comparison is effected, however, there is always a further source of ambiguity: whether migration in some sense "causes" achievement, or whether migration is merely selective of those men with qualities like energy and ambition which would lead to

above-average achievement, irrespective of the decision to migrate. While this ambiguity cannot be finally resolved, it is possible to standardize the comparisons for characteristics already known to influence occupational achievement. These factors, as set forth in our basic model, include the three standard characteristics of the family of orientation and the respondent's schooling.

One other element figures prominently in the present analysis--the classification of migrants according to farm vs. nonfarm background, as ascertained from the question on father's occupation. In earlier work (Blau and Duncan, 1967, chapter 8) the impact of farm background on occupational achievement was treated in a somewhat unsatisfactory way, and it was not possible to present the proper comparisons with regard to migration status. Most men living in nonfarm areas but having farm background are, of course, migrants. For clarity, they should be compared with both nonmigrants in those areas and migrants with nonfarm background. Moreover, it seems strategic to control the size of the community of residence in such comparisons. Migrants with farm background will have moved in disproportionate numbers to the smaller nonfarm communities, while the other two categories of men will be spread over the city-size distribution. If opportunity structures are more favorable in large places, a comparison between men with farm background and those with nonfarm background which did not control for this factor could lead to an erroneous impression of the influence of background as such.

It is quite clear that the migration classification captures significant variation in occupational status. Table 9.3.1 shows that migrants with nonfarm background consistently have higher mean occupational status scores than nonmigrants. In urbanized areas the difference is 4 to 6 points on the status scale; in the smaller urban places and rural nonfarm areas, it is even larger. Almost as consistently, men with farm background score lower on the average than nonmigrants; in urbanized areas the discrepancy is 6 or 7 points, although it disappears entirely in the smaller urban places and is rather smaller in rural nonfarm areas. Inasmuch as migrants with nonfarm background compare favorably with nonmigrants while migrants with farm background compare unfavorably, there is little question about the comparison between the two categories of migrants: those with nonfarm background have very substantially higher mean occupational status scores than those with farm background.

These crude comparisons do not, therefore, provide an unequivocal indication of the effect of migration as such on occupational achievement. The very direction of such an effect appears to depend on farm vs. nonfarm background. Moreover, we have not yet examined any material relevant to the selectivity hypothesis.

To pursue this question, multiple regressions of occupational status on family background and educational attainment were computed for each migration category within each of the five size-of-community

Table 9.3.1.--Mean Occupational Status Scores for Native Non-Negro Men  
25 to 64 Years Old Living in Nonfarm Residences and in the  
Experienced Civilian Labor Force, by Migration Status:  
March 1962

Size of Place (Residence in March 1962)	Nonfarm Background		Farm Background, Migrant
	Nonmigrant	Migrant	
Urbanized Areas			
1,000,000 or more	42.7	48.9	36.4
250,000 to 1,000,000	44.6	48.7	38.8
50,000 to 250,000	41.3	47.5	34.7
Other Urban Places	37.5	47.2	37.9
Rural Nonfarm	33.8	42.0	30.3

Source: OCG data set. (Note: Men with farm background classed as non-migrants are excluded because of the small frequencies. "Farm background" refers to men who reported father's occupation as farmer or farm laborer.)

classes. The results are shown in Tables 9.3.2 and 9.3.3. In planning these computations there was some expectation that the results might show some clear and readily interpretable interactions--relationships, that is, that are much stronger or weaker in one migration category than in another. Apart from fluctuations apparently due to sampling variation and some artifacts of the definitions, there do not appear to be many such interactions to report.

For example, it might be thought that the migrant would be a person who had managed to free himself from the influence of his family of orientation and the social circle within which it moves, and, therefore, that the influence of family background on achievement should be less for migrants than for nonmigrants. The most relevant summary statistics for this hypothesis are found in Table 9.3.2 in the column of coefficients of determination for migrants and nonmigrants, both with nonfarm background. In brief, the comparisons are not consistent over community-size categories and certainly do not support the hypothesis in question. Similarly there is not much to be said in regard to the comparison between the first two panels of regression coefficients in Table 9.3.2. One might be inclined to conclude that number of siblings has a rather greater impact on occupational achievement of migrants (with nonfarm background) than on that of nonmigrants. There is no suggestion of a consistent comparison with respect to the other two variables, however.

The inclusion of the third panel in each of these two tables involves a calculated risk of creating misleading impressions. The

Table 9.3.2.--Regression Coefficients Describing Relationships of Occupational Status (Y) to Family Background, by Migration Status, for Native Non-Negro Men 25 to 64 Years Old Living in Nonfarm Residences and in the Experienced Civilian Labor Force: March 1962  
 [Parentheses ( ) enclose coefficient smaller than its standard error]

Migration Status and Size of Place (Residence in March 1962)	Independent Variable			Coefficient of Deter- mination
	Number of siblings (T)	Father's occupation (X)	Father's education* (V)	
<b>NONMIGRANTS, NONFARM BACKGROUND</b>				
<b>Urbanized Areas</b>				
1,000,000 or more	-1.228	.274	1.634	.153
250,000 to 1,000,000	-.965	.367	.594	.176
50,000 to 250,000	-.707	.309	2.753	.209
Other Urban Places	-.779	.258	1.787	.134
Rural Nonfarm	-1.370	.269	1.379	.170
<b>MIGRANTS, NONFARM BACKGROUND</b>				
<b>Urbanized Areas</b>				
1,000,000 or more	-1.224	.267	1.294	.154
250,000 to 1,000,000	-1.147	.305	1.646	.188
50,000 to 250,000	-1.292	.259	1.572	.156
Other Urban Places	-1.382	.297	1.888	.178
Rural Nonfarm	-1.606	.273	1.711	.191
<b>MIGRANTS, FARM BACKGROUND</b>				
<b>Urbanized Areas</b>				
1,000,000 or more	(.060)	(-.162)	2.683	.029
250,000 to 1,000,000	-1.612	1.035	2.818	.118
50,000 to 250,000	-1.284	(.046)	1.564	.050
Other Urban Places	-1.017	1.077	2.887	.078
Rural Nonfarm	(-.089)	.541	3.157	.051

\*V is in units of a convenient coding of school years completed.

Source: OCG data set.

Table 9.3.3.--Regression Coefficients Describing Relationship of Occupational Status (Y) to Family Background and Educational Attainment, by Migration Status, for Native Non-Negro Men 25 to 64 Years Old Living in Nonfarm Residences and in the Experienced Civilian Labor Force: March 1962  
[Parentheses ( ) enclose coefficient smaller than its standard error]

Migration Status and Size of Place (Residence in March 1962)	Independent Variable				Coeffi- cient of Deter- mination
	Edu- cation (U)	Number of siblings (T)	Father's occu- pation (X)	Father's edu- cation* (V)	
<b>NONMIGRANTS, NONFARM BACKGROUND</b>					
<b>Urbanized Areas</b>					
1,000,000 or more	8.018	-.197	.118	.559	.342
250,000 to 1,000,000	7.482	-.323	.207	(-.451)	.372
50,000 to 250,000	6.684	(.070)	.171	1.719	.350
Other Urban Places	7.685	(.089)	.132	(.175)	.328
Rural Nonfarm	6.058	-.842	.151	(.073)	.295
<b>MIGRANTS, NONFARM BACKGROUND</b>					
<b>Urbanized Areas</b>					
1,000,000 or more	8.463	-.240	.105	(.146)	.399
250,000 to 1,000,000	8.000	(-.172)	.171	(-.056)	.426
50,000 to 250,000	8.241	-.356	.128	(.120)	.388
Other Urban Places	8.346	-.404	.125	(.431)	.430
Rural Nonfarm	7.494	-.804	.134	(.026)	.399
<b>MIGRANTS, FARM BACKGROUND</b>					
<b>Urbanized Areas</b>					
1,000,000 or more	7.460	.871	-.541	(-.149)	.298
250,000 to 1,000,000	8.156	-.636	(.313)	1.388	.432
50,000 to 250,000	6.860	-.677	(-.486)	-1.120	.260
Other Urban Places	6.417	(-.164)	.830	1.218	.283
Rural Nonfarm	6.528	.469	(.076)	(.223)	.255

\*V is in units of a convenient coding of school years completed.

Source: OCG data set.

truth is that the regression results for men with farm background cannot be compared directly with those for men with nonfarm background. This is because one of the variables in the basic model--father's occupation--is involved in the very definition of farm background. Men with such background are defined as those reporting their fathers' occupations as farmers, farm managers, farm laborers, or farm foremen. There is comparatively little variation in occupational status within this category, therefore. Although a regression coefficient can be computed for variable X, it is difficult to be sure what interpretation can be placed on it. Moreover, since the variation in X is sharply reduced by comparison with the groups with nonfarm background, coefficients of determination may not be compared between the third panel and the other two. Finally, in view of the small samples of men with farm background in several of the community-size groups there is a good deal of sampling variation in the results.

Taking account of all these limitations on the comparisons, perhaps the one conclusion that can be tentatively suggested is that the impact of father's education on respondent's occupational achievement is somewhat greater for migrants with farm background than for either nonmigrants or migrants with nonfarm background. Even in this case, not all the comparisons in Table 9.3.2 are consistent with the summary statement.

If it is difficult to isolate clear interactions of migration status with family background variables, we have some warrant for treating the effect of migration as simply additive to the effects of the family variables. We shall presently take advantage of the convenience of this assumption. One more comparison, however, should be mentioned. In Table 9.3.3, where educational attainment, along with family background, is regarded as an influence on occupational achievement, it appears that its impact is somewhat greater for migrants with nonfarm background than for either nonmigrants or migrants with farm background (although one of the five comparisons involving the latter does not fit this conclusion). This result is seen not only in the regression coefficients for variable U, but also in the fact that the coefficients of determination are uniformly higher in the second than in the first panel of the table.

We should, of course, bear in mind that an apparently consistent comparison over five community-size groups might be expected to occur occasionally as a chance result of sampling fluctuations. Moreover, the magnitudes of the differences in regressions coefficients are not uniform and in several cases are virtually negligible. We leave it as a tentative conclusion that nonfarm migrants may be somewhat advantaged in regard to the ease of converting educational attainment into occupational achievement; but a model that assumes no such effect will, nevertheless, not greatly distort the data.

In Table 9.3.4, therefore, we have standardized the comparisons of mean occupational achievement for family background and education on



Table 9.3.4.--Gross and Net Effects of Migration Status on Occupational Status, by Size of Place, for Native Non-Negro Men 25 to 64 Years Old Living in Nonfarm Residences and in the Experienced Civilian Labor Force: March 1962

Migration Status and Size of Place (Residence in March 1962)	Gross Effect**	Effect, Net of--	
		Socioeconomic Background***	Background and Education
<b>MIGRANTS, NONFARM BACKGROUND*</b>			
Urbanized Areas			
1,000,000 or more	6.2	4.4	2.4
250,000 to 1,000,000	4.1	2.8	0.5
50,000 to 250,000	6.2	2.7	0.6
Other Urban Places	9.8	8.2	5.4
Rural Nonfarm	8.3	5.4	3.5
<b>MIGRANTS, FARM BACKGROUND*</b>			
Urbanized Areas			
1,000,000 or more	-6.3	2.5	1.5
250,000 to 1,000,000	-5.8	3.6	2.4
50,000 to 250,000	-6.6	2.4	2.1
Other Urban Places	0.4	6.8	4.9
Rural Nonfarm	-3.5	2.9	2.9

\*See source note, Table 9.3.1.

\*\*Deviation of mean for given migration class from mean for nonmigrants with nonfarm background.

\*\*\*Includes family head's education (V), his occupation (X), and respondent's number of siblings (T).

Source: OCG data set.

the assumption of additive effects. Operationally, the "net" effects were computed by substituting the mean values of independent variables for each of the migrant groups into the regression equation for nonmigrants and comparing the implied mean occupational score from this calculation with the actual mean for the migrant group. For example, the regression of occupational status on number of siblings, father's occupation, and father's education, for nonmigrants in the largest urbanized areas is as follows:

$$\hat{Y} = 33.0 - 1.2 T + .27 X + 1.6 V;$$

and the mean of Y in this group is 42.7 (as shown earlier). If we substitute into this equation the mean scores of migrants with nonfarm background--to wit,  $\bar{T} = 3.48$ ,  $\bar{X} = 36.5$ , and  $\bar{V} = 3.53$  (V is in units of a convenient coding of school years completed)--we obtain as the expected value of Y, 44.5. But the actual mean of Y for migrants with nonfarm background is 48.9. Hence, the effect of this migration category, net of the three family characteristics, is taken to be  $48.9 - 44.5 = 4.4$  (the value shown in the first row, second column of Table 9.3.4). By the same procedure, using the appropriate regression and set of means, we infer that the net effect of this category, when not only the three family variables but also education is taken into account, is 2.4 points on the occupational status scale.

Let us inspect first the top panel of Table 9.3.4. The difference between gross effects and net effects bears on the hypothesis of selective migration. It appears, in fact, that a substantial part of the differential in occupational achievement is due to the fact that migrants are favorably selected with respect to such background traits as family size and socioeconomic level. The comparison between the two sets of net effects is likewise instructive. The result that net effects are smaller when education is taken into account along with the family variables than when only the latter are standardized for indicates that educational differentials may be a significant aspect of the mechanism by which migration status is converted into differential occupational achievement. Indeed, in two of the community-size groups, the net effects after the education variable has been accounted for are essentially nil. Yet these net effects remain positive--i.e., they favor migrants with nonfarm background over nonmigrants--in all five community-size groups. The model only partially explains the differential initially observed (see the column of gross effects) and leaves open the question of what other mechanism or principle of selectivity may account for the superior achievement of migrants.

In the second panel of Table 9.3.4 the results are even more interesting. The column of gross effects shows, as did Table 9.3.1, that migrants with farm background compare unfavorably with nonmigrants (and, *a fortiori*, with migrants with nonfarm background) in regard to crude mean occupational scores. This differential, signified by the negative sign of the gross effect, is, however, reversed when standardization for family background is effected in the middle column of the

table. That is, if we could directly compare migrants from farms with a group of nonmigrants who originated in equally large families at equally low levels of socioeconomic status, these results suggest that the farm migrants would actually appear to an advantage. Viewed in this light, migration is a favorable experience--or at least a favorable sign--irrespective of farm vs. nonfarm background. The net effects are much alike for the two groups of migrants. The implication is, moreover, that the substantial difference between the two groups of migrants observed in their crude occupational mean scores is almost wholly due to the advantageous family backgrounds of the nonfarm men.

Finally, we may observe that some part of the superior occupational achievement of farm migrants relative to nonmigrants of comparable family background is effected via education. This appears from the fact that the net effects in the third column of Table 9.3.4 are slightly smaller than those in the second. This comes about in virtue of the fact that educational attainment of migrants is slightly superior to that of nonmigrants, once a standardization for family background is effected. The details of the analysis leading to this summary conclusion are displayed in Table 9.3.5, and do not require further comment since they fall into a pattern of the kind already described.

#### 9.4. Disruption of Marriage

Differentials in occupational achievement among men who were living with their spouses on the survey date, men who reported their marital status as divorced, and men who reported that they were separated, i.e., married but living apart from their spouses, are investigated in this section. Differential achievement on the part of never-married or widowed men is not explored because the probability of being in the status is so closely linked to age and the only age control in the analysis is restriction of the study population to males aged 25 to 64 on the survey date. The study population is further restricted by the exclusion of Negro respondents, the foreign born, the men reared in families headed by a farm worker, and the men reared in broken families, that is, one or both parents were absent from the home in which the respondent lived as an adolescent.

On the survey date, the men living with their spouses were pursuing occupations with a mean socioeconomic status score some seven points higher than the mean score of the occupations pursued by divorced or separated men. The difference amounts to about three-tenths of a standard deviation for the score in the study population. There is no difference between divorced and separated men with respect to occupational achievement on the survey date. At the time these men took their first civilian job, however, there had been no differentiation as between the men who were to be found living with their spouses on the survey date and the men were to report themselves as divorced; both groups had held occupations ranking higher in the occupation structure

Table 9.3.5.--Mean Number of Years of School Completed, by Migration Status, for Native Non-Negro Men 25 to 64 Years Old Living in Nonfarm Residences and in the Experienced Civilian Labor Force: March 1962

Size of Place (Residence in March 1962)	Nonfarm Background		Farm
	Non- migrant	Migrant	Background, Migrant
<u>Observed means</u>			
Urbanized Areas			
1,000,000 or more	11.6	12.3	10.4
250,000 to 1,000,000	11.5	12.3	10.5
50,000 to 250,000	11.5	12.6	10.2
Other Urban Places	11.1	12.0	10.5
Rural Nonfarm	10.5	11.6	9.5
<u>Gross effects*</u>			
Urbanized Areas			
1,000,000 or more	...	0.7	-1.2
250,000 to 1,000,000	...	0.8	-1.0
50,000 to 250,000	...	1.1	-1.3
Other Urban Places	...	0.9	-0.6
Rural Nonfarm	...	1.1	-1.0
<u>Effects net of family background**</u>			
Urbanized Areas			
1,000,000 or more	...	0.5	0.2
250,000 to 1,000,000	...	0.6	0.3
50,000 to 250,000	...	0.6	0.1
Other Urban Places	...	0.7	0.5
Rural Nonfarm	...	0.6	0.0

\*Deviation from mean for nonmigrants.

\*\*Includes family head's education (V), his occupation (X), and respondent's number of siblings (T).

Source: OCG data set.

than the occupations held by men who were to report themselves as separated on the survey date. The difference in mean scores with respect to the occupation of the first job amounted to some six points on the socio-economic status scale, or about a quarter of a standard deviation. Progress in the occupation structure subsequent to entry, as indexed in the mean difference between the scores of the first and current occupations, has been substantially greater among the men currently living with their spouses or separated from them (14 and 13 scale points, respectively) than among the men whose current marital status is divorced (six scale points). The mean scores and standard deviations on which these observations are based appear in Table 9.4.1.

Now it must be made clear that marital status is measured at a given point in time. Among the separated men are individuals who will remain in the status for a more or less indefinite period and also individuals who will make the transition into the divorced status and perhaps eventually re-enter the spouse-present status, for example. Hence, the differentials cannot be attributed in any direct sense to the fact of separation or divorce. They serve only to differentiate the incumbents of the respective statuses at a given point in time.

With this limitation on the interpretation of the data made explicit, we proceed to examine differentials with respect to other antecedent social characteristics. The current marital-status groups are not notably differentiated with respect to the sizes and socio-economic levels of the families in which they grew up; the maximum intergroup difference does not take on a value as great as a quarter of a standard deviation for any given family-background indicator. Sharper differentiation is to be observed with respect to the respondent's educational attainment, his age at first job, and his age at first marriage. Educational attainment is relatively low, age at first job relatively young, and age at first marriage relatively advanced for the divorced men by comparison with either the men currently living with their wives or the group of men who report themselves as separated or living apart from their spouses.

Viewed as a set, the mean scores on the several variables for the divorced men are anomalous. Their educational attainment appears atypically low, and their age at first job appears atypically young given their social background. The socio-economic status of their first occupations appears high given their educational qualifications and ages at the time of work-force entry. Moreover, the relation of current occupation to respondent's education or first occupation among the divorced males is unusual by comparison with the corresponding relation in most other subpopulations of survey respondents studied. The coefficient of correlation between first and current occupation, for example, takes on a value of .76 for the divorced men, in contrast to .52 for the spouse-present men or .50 for the separated men. The correlation coefficient between education and current occupation takes on a value of .46 for the divorced men, in contrast to .61 for the spouse-present men or .64 for the separated men. Unfortunately the number of respondents in the

Table 9.4.1.--Mean Scores and Standard Deviations on Selected Variables for Native Non-Negro Civilian Males Age 25 to 64, with Nonfarm Background and Reared with Both Parents, by Current Marital Status: March 1962

Variable	Spouse Present	Spouse Absent	
		Divorced	Separated <sup>a</sup>
<u>Mean score</u>			
<b>Father's--</b>			
Education	8.61	8.87	8.16
Occupation	34.58	31.21	29.17
<b>Siblings</b>			
Education	3.89	3.74	4.24
Education	11.87	10.95	11.51
<b>First job--</b>			
Age	18.59	17.88	18.69
Occupation	30.95	30.88	25.21
Age at first marriage	24.20	25.53	24.41
Current occupation	45.12	37.16	37.82
<u>Standard deviation</u>			
<b>Father's--</b>			
Education	3.66	3.94	3.23
Occupation	22.87	20.10	21.38
<b>Siblings</b>			
Education	2.92	2.63	3.27
Education	3.22	2.89	3.01
<b>First job--</b>			
Age	2.97	2.75	4.29
Occupation	22.43	21.88	19.69
Age at first marriage	4.73	5.96	5.35
Current occupation	24.46	24.24	24.00

<sup>a</sup>Includes "married, spouse absent."

Source: OCG data set.

divorced status is too small to permit calculation of reliable measures either for populations other than the one under study here or for subgroups within that study population.

On the assumption that the influences of antecedent social characteristics on achievement do not, in fact, differ among the subgroups defined by current marital status (that is, the apparent difference for divorced men represents a sampling fluctuation), we proceed to measure the effect of marital status on occupational success. The gross effect of a broken marital status on occupational success is a handicap of seven to eight points on the occupation scale (first row of Table 9.4.2). The effect of a separated status appears to be a handicap of about five points when allowance is made for slight disadvantages in social background and educational attainment for the separated relative to the spouse-present men. Allowance for the first occupation as well as social background and educational attainment reduces the handicap of the separated to four scale points (fourth row of Table 9.4.2). The difference in social background between divorced and spouse-present men is so slight that the effect of a divorced status on occupational success is reduced by less than a scale point when allowance is made for the background differential. When allowance for the respondent's education or education and first job also is made, however, the handicap of a divorced status falls to about four scale points. Overall, then, the observed handicap of about eight points associated with a broken marital status is reduced to about four points when respondents in the intact and broken marital statuses are "matched" statistically with respect to social background, educational attainment, and entry occupation. The fact that a measurable handicap remains after such adjustment suggests that disruption of marriage is a significant career contingency, though by no means one that accounts for any substantial part of the total variance in occupational achievement.

#### 9.5. Marital Fertility

The purpose of this section is to raise for discussion a point of view on the relationship between achievement and marital fertility that makes a different kind of assumption from the standard one in the literature and to report some results obtained on this point of view.

In studies of differential fertility, including those involving measures of social or occupational mobility, fertility (however measured) is usually taken as the dependent variable and measures of status as the independent variables. Thus, census tables on marital fertility show us number of children ever born or number of children under five years old per wife or per couple, where the couples are classified by (say) husband's income, husband's occupation, or the education of one or both spouses. Analysts working with these data sometimes note that income or occupation, ascertained as of the census date (or during the year preceding the census, as in the case of income) may not accurately represent

Table 9.4.2.--Summary of Effects of Current Marital Status on Occupational Achievement, for the Population Covered in Table 9.4.1

Item	Spouse present	Spouse Absent	
		Divorced	Separated
Gross effect	0.0	-8.0	-7.3
Effect net of social background (father's education and occupation and number of siblings)	0.0	-7.4	-4.9
Effect net of background and respondent's education	0.0	-3.8	-4.9
Effect net of background, education, and first occupation	0.0	-4.6	-4.0



the income or occupation level of the couple at the time childbearing was taking place. Education, on the other hand, can more reasonably be taken as an antecedent to fertility, in that most of the childbearing period follows the completion of formal schooling by each spouse. Despite the general recognition of the anomalies generated by taking (past) fertility to depend upon (current) occupation and income, analysts have not often explored the consequences of an alternative assumption.

What is proposed here is that we consider causal models in which the status variables and fertility are ordered with regard to their presumed temporal sequence. On this point of view, we should have to regard the number of children born to a couple as a factor which intervenes between background factors--such as socioeconomic level of origin and educational attainment--and the achievement of current socioeconomic statuses. Since the number of births to a couple is not perfectly predictable from its combination of background factors, fertility would then operate as a "contingency" with respect to occupational status or income as observed at the end of the childbearing cycle or (for couples not beyond the age of childbearing) at the end of the period of observation.

Figure 9.5.1 presents a causal model embodying these assumptions. The data required for illustrative calculations on this model come from the fertility tabulations prepared from the OCG data set. The following items of "background" information are available: the occupational status of the fathers of the respective spouses, as of the time the spouse was about 16 years old; the status of the husband's first job; the number of years of schooling completed by the husband and by the wife. All occupation items are scored on Duncan's (1961a) scale. The measure of fertility is number of children ever born to the wife. For the minority of couples in which either or both spouses were married more than once, part of this fertility may not be correctly attributed to the couple under observation. This error is assumed to be minor in the present context.

Two measures of achievement pertaining largely if not wholly to dates subsequent to the birth of the children are the husband's occupation at the date of the survey (March 1962) and his income in 1961.

The temporal ordering of these variables cannot be completely unambiguous. Childbearing may, of course, have been under way before education was completed, even though for most couples the greater part of it must have occurred subsequently to the termination of schooling. For a few couples, childbearing may have commenced before the husband entered his first job, but again the error in taking first job as antecedent to fertility must be fairly small. With respect to the terminal achievement variables, we have no way of knowing the husband's length of tenure in his 1962 occupation. Conceivably, a substantial minority of husbands may have entered their current jobs a number of years before some of the children were born. We are inclined to guess, however, that

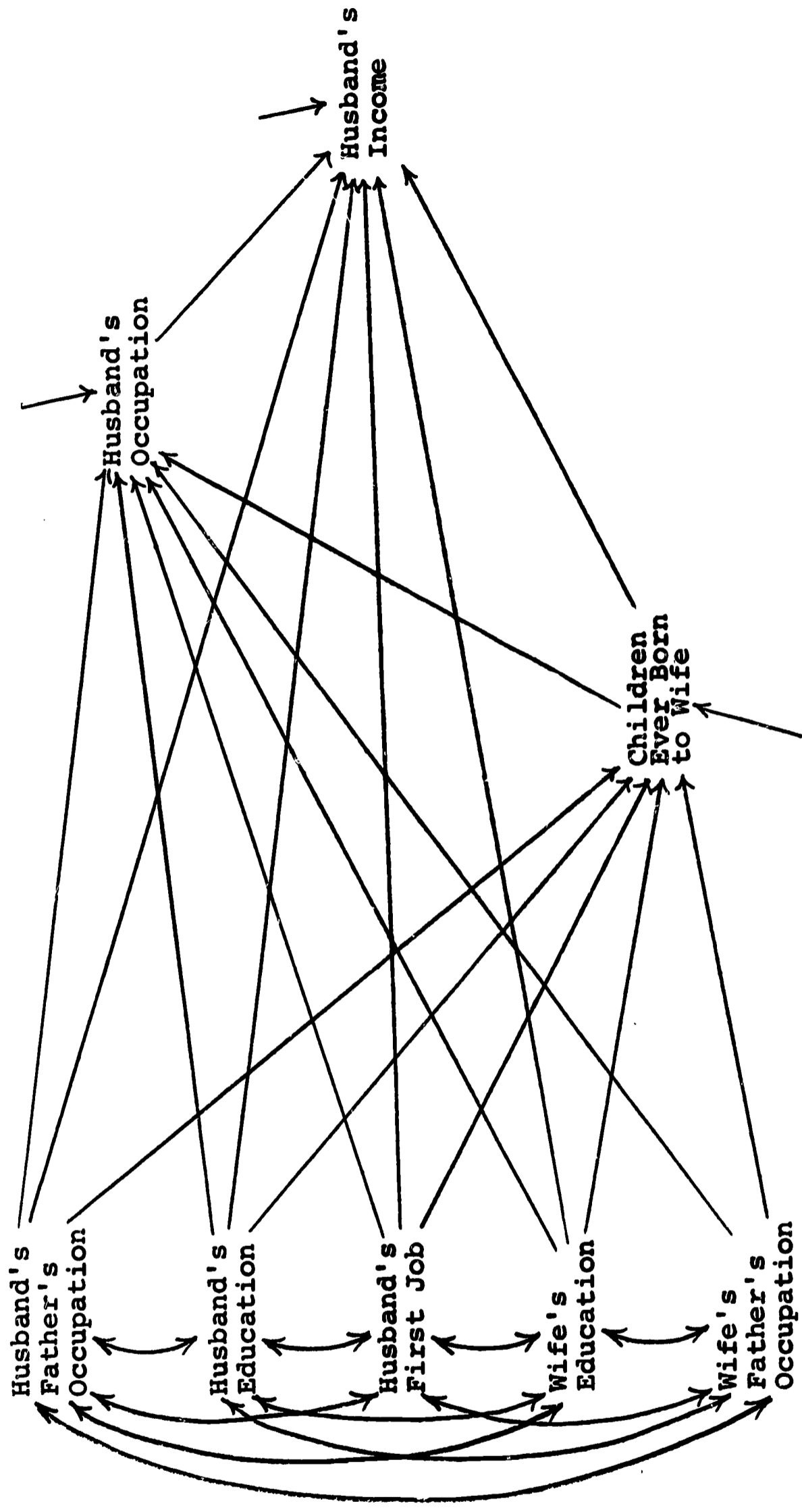

Figure 9.5.1.--Causal Model Interpreting Fertility as a Career Contingency.

such cases are indeed a minority and, at some ages, perhaps a small minority. The postulated direction of relationship between occupation and income (the former preceding the latter) may be in error for husbands changing their line of work within the 15 months preceding the survey.

While Figure 9.5.1, therefore, is open to criticism as a literal reading of temporal relationships, it is no doubt less open to such criticism than the assumption made in conventional analyses (where the assumption is, by the way, usually tacit). As a causal diagram, Figure 9.5.1 may seem still more inadequate. One could argue, for example, that couples with a given configuration of background characteristics anticipate the income level they will have at various stages of child-bearing and adjust their fertility accordingly. Such an argument, however, should not be taken to justify a reordering of the variables in Figure 9.5.1. It should, on the contrary, lead the analyst to insert another variable, "anticipated income," into the diagram in whatever position he believes it should occupy. Presumably, then, the relationship of anticipated income to actual income in a given year would be less than perfect, and part of the analysis would have to be designed to take into account this imperfect relationship.

Let us, however, beg the question of how one might plausibly complicate the causal diagram. The pattern of results obtained with the interpretation offered by the present diagram may prove suggestive as to ways in which such complications should be undertaken.

Our causal model includes the assumptions that fertility depends on five background factors; occupation depends on the same background factors and on fertility along with them; and income depends on occupation, fertility, and the five background factors. We have then to compute a recursive set of three multiple regressions. If the data are expressed in standard form (each variable having zero mean and unit standard deviation), the path coefficients for the diagram in Figure 9.5.1 are the standardized partial regression coefficients (or "beta" coefficients) of these multiple regressions.

In Table 9.5.1 we show the results of these regression calculations for each of eight cohorts of couples, distinguished according to age of wife. As an aid in assessing the results of the calculations, we have made rough estimates of standard errors of the beta coefficients, taking into account the actual size of the samples and a conjectural allowance for the effect of departure of the sample design from simple random sampling. If anything, the standard errors are perhaps a little too large. Hence, we consider any coefficient larger in absolute value than twice its standard error as being clearly significant (i.e., too large to attribute solely to sampling variation), and any coefficient at least equal in absolute value to its standard error as being possibly significant.

Table 9.5.1.--Partial Regression Coefficients in Standard Form Relating Fertility, Husband's Occupation, and Income to Socioeconomic Background, for Intact White Couples, by Age of Wife: Civilian Non-institutional Population of the United States, 1962

Age of Wife	Dependent Variable	Independent Variables							Coefficient of Determination (R <sup>2</sup> )
		Husband's Occupation	Fertility	Husband's education	Husband's first job	Husband's father's occupation	Wife's education	Wife's father's Occupation	
22 to 26	Fertility	...	...	-.131**	.005	-.058*	-.261**	-.026	.15
	Husband's Occ.	...	.030*	.399**	.310**	.024	.061**	.056**	.48
	Husband's Income	.304**	.046*	.017	.035	.026	.032	... <sup>a</sup>	.13
27 to 31	Fertility	...	...	-.064*	-.049*	-.006	-.178**	.043*	.06
	Husband's Occ.	...	-.001	.419**	.242**	.081**	.069**	.101**	.53
	Husband's Income	.340**	.051*	.047*	-.018	.130**	.065*	... <sup>a</sup>	.22
32 to 36	Fertility	...	...	-.096**	-.021	.009	-.096**	.070**	.03
	Husband's Occ.	...	-.002	.448**	.210**	.095**	.044*	.064**	.48
	Husband's Income	.272**	.061**	.054*	.106**	.123**	.152**	... <sup>a</sup>	.29
37 to 41	Fertility	...	...	-.089**	-.012	.009	-.115**	.019	.03
	Husband's Occ.	...	-.029*	.387**	.195**	.091**	.064**	.070**	.41
	Husband's Income	.312**	.057**	.151**	.085**	.091**	.090**	... <sup>a</sup>	.32
42 to 46	Fertility	...	...	-.057*	-.044*	-.039*	-.093**	.055*	.03
	Husband's Occ.	...	.004	.400**	.213**	.072**	.052*	.063**	.40
	Husband's Income	.313**	.024	.151**	.074**	.072**	.040*	... <sup>a</sup>	.27
47 to 51	Fertility	...	...	-.120**	-.011	.000	-.121**	-.012	.05
	Husband's Occ.	...	-.051**	.383**	.199**	.118**	.070**	.027*	.43
	Husband's Income	.332**	.036*	.125**	.098**	.093**	.056*	... <sup>a</sup>	.31
52 to 56	Fertility	...	...	-.052*	-.070*	-.044*	-.191**	.003	.08
	Husband's Occ.	...	-.054*	.305**	.206**	.074**	.081**	.082**	.35
	Husband's Income	.354**	-.055*	.136**	.068*	.116**	-.007	... <sup>a</sup>	.31
57 to 61	Fertility	...	...	.001	-.090*	-.056*	-.129**	-.100*	.08
	Husband's Occ.	...	-.031	.319**	.251**	.149**	.038	.071*	.42
	Husband's Income	.230**	-.056*	.107*	.108*	.054*	-.006	... <sup>a</sup>	.18

\*Coefficient greater than its standard error but less than twice as great (in absolute value).

\*\*Coefficient greater than twice its standard error (in absolute value).

<sup>a</sup>Not computed; data not available.

Before considering the effects of fertility on achievement which are suggested by the results in Table 9.5.1, we may consider briefly how the background factors appear to affect fertility. The first line of the three shown for each age group provides the path coefficients measuring the direct effects of the variables listed in the boxhead of the table. The factor which is consistently most important, and indeed the only one whose effect is completely consistent over all age groups, is wife's education. Well educated wives have fewer children than poorly educated wives. Similarly, in all age groups but the last, husband's education is negatively related to fertility, and with the same exception emerges as the second most important direct influence. Husband's first job, where it has a significant effect, likewise relates negatively to fertility, although by comparison with the education effects, first job never has a marked influence. A similar statement can be made for husband's father's occupation. The results for wife's father's occupation, however, are quite erratic. Three of the significant or possibly significant coefficients are positive, as are two of the non-significant ones. The remaining three coefficients are negative, although only one is substantially so.

In summary, at least four of the background factors relate negatively to cumulative fertility at any age in a reasonably consistent fashion, but only education, particularly that of the wife, has especially strong effects.

According to the model, once fertility has been determined by the background factors in combination with the overwhelmingly important residual factors not explicitly identified in the model, it may in turn influence subsequent status achievement. To facilitate discussion of this influence, a schematic summary of the results is given below:

<u>Age Group</u>	<u>Direct Effect of Fertility on:</u>	
	<u>Occupation</u>	<u>Income</u>
22-26	+	+
27-31	(-)	+
32-36	(-)	++
37-41	-	++
42-46	(+)	(+)
47-51	- -	+
52-56	-	-
57-61	(-)	-

Here we show only the sign of the effect; one symbol means the effect is possibly significant on the criterion previously stated, while the double symbol means it is clearly significant. Nonsignificant coefficients are enclosed in parentheses.

The first conclusion one might reach is that fertility is not a major influence on achievement, since only three of the 16 coefficients are clearly significant, and the largest of them is no greater than .061. If we accept the signs of the coefficients at face value, however, we can summarize the results in this way: The effect of fertility on occupational achievement (if any) is negative. Except in the youngest age group, the coefficient for the direct influence of fertility on 1962 occupational status is either negative or nonsignificant. By contrast, the effect (if any) of fertility on income is positive, excluding the two oldest age groups.

We are here observing net or direct effects. These need not be comparable in magnitude, nor even the same in sign, as the total or gross associations. Table 9.5.2 shows, in fact, that the zero-order correlation of fertility with each and every one of the status variables --both those identified as background factors and those taken to be measures of subsequent achievement--is negative, with the single exception of the correlation of fertility with wife's father's occupation for one age group.

Thus, the net effect of fertility on occupational achievement is generally consistent as to sign with the zero-order correlation between the two variables. In the case of income, however, six of the age groups show a reversal of sign. All simple correlations between income and fertility are negative; the net effects of fertility in this model are positive, for the six age groups through age 51.

The meaning of a net effect in this context is, of course, strictly relative to the particular model with which we are working. We are allowing occupation to be influenced by the five background factors as well as by fertility. When their effects on both occupation and fertility are taken into account, fertility is seen to have little direct effect of its own, but such as it is, the effect on occupational achievement is (generally) negative.

Again, occupation and the five background variables are taken to be influences on income. Allowing for these, we seem to detect a slight positive effect of fertility on income. Phrased differently, the negative association of fertility with background factors appears to mask its direct positive effect on income, so that the gross association between income and fertility is spuriously negative. When we allow for the operation of other variables in the complex of background and achieved statuses, fertility (with the two exceptions noted) seems to enhance income.

The possibility that income has a net positive association with fertility, once other socioeconomic characteristics are held constant, has been noted in previous research (Freedman, 1963). The interpretation of fertility as a "cause" of certain of these characteristics was, however, not ventured in that research. This interpretation, therefore, is a departure from current thinking, and requires justification.

Table 9.5.2.--Simple Correlations between Fertility and Socioeconomic Variables, for Intact White Couples, by Age of Wife: Civilian Noninstitutional Population of the United States, 1962

Socioeconomic Variable	Age of Wife							
	22 to 26	27 to 31	32 to 36	37 to 41	42 to 46	47 to 51	52 to 56	57 to 61
Husband's income in 1961	-.045	-.032	-.008	-.032	-.044	-.084	-.184	-.149
Husband's occupational status, 1962	-.200	-.146	-.093	-.124	-.088	-.184	-.200	-.189
Husband's education	-.326	-.187	-.135	-.148	-.134	-.203	-.223	-.188
Husband's first job status	-.204	-.150	-.089	-.092	-.108	-.130	-.185	-.194
Husband's father's occupational status	-.202	-.101	-.054	-.066	-.090	-.104	-.146	-.177
Wife's education	-.370	-.222	-.133	-.158	-.135	-.202	-.259	-.220
Wife's father's occupational status	-.182	-.070	.000	-.054	-.024	-.099	-.106	-.201

Perhaps the most plausible ground for this interpretation is that a man with many children, if he proposes to support them, is highly motivated to seek and retain such employment as will yield the greatest total income among the alternatives that may be open to him. He is not in a favorable position to trade off some decrement to his earnings for a job with higher prestige or better working conditions, for example. Indeed, he may find it expedient to hold more than one job simultaneously in view of the need for the additional income afforded by the second job. A recent study (Hamel, 1967, p. 18) reports: "Data available for the first time show that . . . the moonlighting rate tends to increase with the number of children under age 18." The rates of multiple jobholding for married men aged 25 to 54, classified as male household heads with wife present and at work during the survey week in May 1966, are given (Hamel, 1967, Table 0) below, by number of children in the household under age 18:

none	5.9 per cent
one	8.7
two	9.1
three or four	9.7
five or more	9.9

The report does not reveal by how much the additional job increased the income available from the primary job.

The OCG data do not include information on multiple jobholding, so that it may only be conjectured that this phenomenon contributes to the relationship observed here. Consistent with this conjecture is the fact that the positive net coefficient for income on fertility does not appear for the two oldest cohorts of wives. At these ages at least some of the children ever born are likely to have left home and no longer to represent a claim on the father's income.

While these and other considerations may conceivably rationalize the finding that income is positively related to fertility when occupation, education, and other socioeconomic background factors are held constant, we must not overlook the possibility that the result is a mere artifact of multicollinearity among the independent variables. This problem has been mentioned earlier in this report. Other workers have noted that in such a situation it frequently happens that the coefficient of the independent variable least closely related to the dependent variable will change in sign when the other independent variables are held constant. Systematic illustrative calculations by Fox and Cooney (1954) disclose the arithmetic basis of this result, although their work affords little basis for deciding whether or when it must be regarded as artifactual.

In any event, it must be clear that the data used here force us to take what is undoubtedly an oversimplified point of view on the system of causal relationships involved. We have observations only on current income and cumulative fertility. Presumably the sequence of events



leading up to the observed association between these variables includes a set of complex reciprocal influences between successive increments to family size and decisions to accept or change jobs. It is customary in making such a comment to note that only detailed life history or longitudinal data could resolve the issue of causation. But it remains to be shown what form such data must take to permit firm inferences and estimates. The main contribution of the exercise reported here, therefore, is merely the suggestion that the problem of interpreting associations between fertility and socioeconomic variables be conceived in a more flexible way than has usually been done in the past.

#### 9.6. Childspacing

Interest in the pattern of childspacing as a career contingency is stimulated by findings reported by Freedman and Coombs (1966) from their longitudinal study of a sample of white couples in Detroit who were initially contacted in 1962. These investigators summarize their results and some implications as follows (pp. 647-648):

The timing of births after marriage has a strong and consistent relationship to the economic position of a sample of white Detroit couples who recently had a first, second, or fourth birth. Whether measured by current income or by the accumulation of several types of assets, a couple's economic position is substantially better the longer the interval to the first birth or the last birth. Those wives already pregnant with their first child at the time of marriage are particularly disadvantaged economically.

These relationships are not a function of the longer duration of marriage of those with long birth intervals and without pre-marital pregnancies. . . .

Taking into account such facts as the duration of marriage and the husband's education does significantly diminish (although it does not eliminate) the relationship between rate of family growth and level of income. . . .

These various relationships are especially striking and consistent for the extreme example of short-childspacing couples who were pregnant at marriage. . . .

We suggest speculatively that all of these data are consistent with the following view. Those who have their children very quickly after marriage find themselves under great economic pressure, particularly if they married at an early age. Opportunities for education or decisions involving present sacrifices for future plans, are difficult. They are less able than others to accumulate the goods and assets regarded as desirable by young couples in our society. They are more likely than others to become discouraged at an early point and to lose interest more quickly than others in the competition for economic success.

It is not possible to perform anything like a strict replication of the Freedman-Coombs study with the data used in this project. The populations are specified by quite different criteria; and, whereas they emphasize current income and accumulated assets as measures of the couple's economic position, the principal dependent variable in the present study is the husband's occupational achievement. Moreover, we are not able to control duration of marriage as Freedman and Coombs did, although we do introduce husband's age at marriage as one of the factors antecedent to current occupational status. In accordance with the general purpose of this report, the present analysis lays heavier emphasis than did that of Freedman and Coombs on characteristics of the husband's family of orientation. Despite these differences, the findings described below may be said to answer in some sense to the plea of Freedman and Coombs for additional research on the possible bearing of patterns of family growth on socioeconomic achievement.

We are concerned here with a rather specialized subset of the OCG data. Some of the limitations on the specification of the subpopulation are dictated by requirements of the technique for estimating intervals between marriage and first birth. The data are restricted to non-Negro native men 25 to 34 years of age who were in the experienced civilian labor force in March 1962. There is a further limitation to men who were then married at least five years, who had been married only once and whose spouses were likewise once-married. Finally, among couples meeting the foregoing restrictions, the estimates are limited to those in which the wife had borne at least one child and all of whose children were still under the age of 14 and living in the household with the husband and wife.

The sample is clearly not representative of all men in the cohort. It excludes men with unusual marriage histories--those never married by the survey date or whose first marriage was disrupted. It further excludes both those beginning their families only recently as well as those whose families began to grow so long ago that the oldest child(ren) have already reached age 14. Altogether, the present analysis is limited to some 48 per cent of all native non-Negro men age 25-34 in the experienced civilian labor force or to some 56 per cent of the ever-married men in this category. Inasmuch as the population itself is defined by a number of career contingencies, the results bear only upon an ex post facto explanation of patterns of occupational achievement for a selected group and would not be valid as a basis for anticipating future achievement on the basis of currently occurring events in the family cycle of a predesignated cohort of men.

Estimation of the interval from marriage to first birth from the OCG data was made possible by the inclusion of the following questions in the March 1962 Current Population Survey: month and year of first marriage; number of children ever born to ever-married women; and month of birth, age at last birthday, and relationship to household head for each member of the household 0-13 years of age. Given the month and year of the mother's marriage and the month and year (inferred from the

age) of the child's birth, the interval from marriage to first birth can be computed with a maximum error of two months. Restricting the estimates to households in which all children ever born are still present and under 14 years of age guarantees that the first-born child is correctly identified.

The gross relationship of occupational status to timing of first birth is depicted in Figure 9.6.1. The data are given here with the most detailed classification of the intervals from marriage to first birth available; it runs by three-month intervals to three years and by one-year intervals to seven years, followed by a three-year interval, seven to nine years, and the open interval, ten or more years. The very long intervals, as one might imagine, are quite sparsely represented in the sample, which includes approximately 1,650 couples.

The figure suggests that there is a quite definite though hardly a simple relationship of occupational achievement to timing of first birth. If we assume that the major irregularities of the regression curve are due to sampling fluctuations, the relationship can be roughly described as a steeply positive gradient of occupational status with increasing interval, up to an interval of three years, followed by a less steeply negative gradient after three years. Unfortunately, the data seem to be especially irregular in the region of the apparent optimum, so that the latter can hardly be estimated with any great precision. It would appear, however, to be in the neighborhood of three years, and thus rather higher than the typical interval. The modal interval is actually 9 to 11 months, and the median is about 17 months.

In the data describing this relationship by itself, there is no particular suggestion that premarital pregnancy affords a special handicap to occupational achievement, apart from that pertaining merely to a very short interval. These data, of course, do not identify the couples who had premarital pregnancies with any great precision. Given the intrinsic error of the estimating procedure, we may only assume that the bulk of the couples in the intervals below six months were married after the first child was conceived, and perhaps some substantial fraction of those classified into the interval six to eight months.

In order to reduce the fluctuations due to sampling error without at the same time obscuring the nature of the relationship, intervals were grouped into a condensed classification, which was used in all further analysis. Table 9.6.1 shows means of the several variables included in the analysis by this condensed classification of intervals from marriage to first birth.

The patterns by which the nine variables are associated with timing of first birth are somewhat mixed. Father's occupation (X) varies with length of interval to first birth in somewhat the same way as respondent's current occupation (Y). We are thus alerted to the possibility that what may appear in Figure 9.6.1 to represent an effect of interval length on occupational achievement may be only a spurious

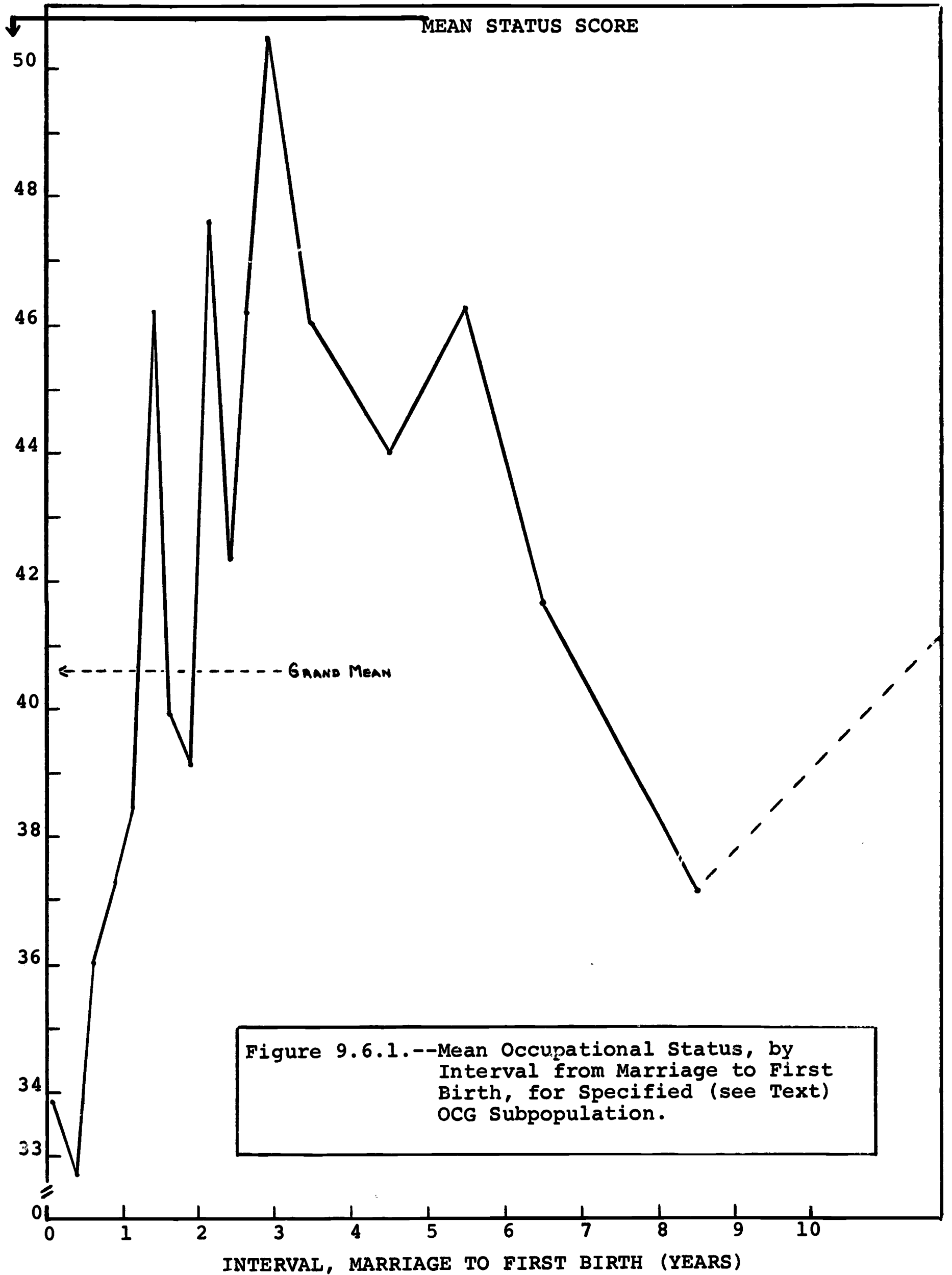

Figure 9.6.1.--Mean Occupational Status, by Interval from Marriage to First Birth, for Specified (see Text) OCG Subpopulation.

Table 9.6.1.--Means of Selected Variables by Interval from Marriage to First Birth, for Special OCG Subpopulation (Defined in the Text): March 1962

Interval	Number of Couples* (1,000's)	Variable**									
		V	X	T	J	M	U	W	Y		
Under 6 months	226	8.0	24.4	4.1	17.9	21.5	11.1	24.4	33.3		
6 to 8 months	362	8.1	25.3	4.3	18.2	20.9	11.4	23.3	36.0		
9 to 11 months	791	8.6	29.2	3.9	18.4	21.4	11.8	27.3	37.3		
12 to 14 months	410	8.5	29.7	4.1	18.5	22.1	11.8	26.2	38.5		
15 to 20 months	673	9.0	29.6	3.7	18.8	21.4	11.9	30.8	42.6		
21 to 26 months	477	8.4	30.0	3.9	18.7	21.5	12.1	28.4	41.8		
27 to 35 months	460	8.6	32.6	3.6	19.0	21.6	12.5	33.5	46.1		
3 years	264	9.3	32.7	3.7	19.1	21.8	12.4	33.3	46.0		
4 to 5 years	261	8.8	31.9	3.3	18.8	21.5	12.5	31.6	44.7		
6 or more years	110	8.2	27.1	3.5	18.4	20.9	11.9	32.9	39.7		
All couples	4,034	8.6	29.5	3.9	18.6	21.5	11.9	28.9	40.6		

\*Number reporting variables U and M; numbers reporting other variables are somewhat smaller (see Appendix B).

\*\*V: Family head's educational attainment

X: Family head's occupational status

T: Number of siblings

J: Age at first job

M: Respondent's age at marriage

U: Respondent's educational attainment

W: Occupational status of respondent's first job

Y: Respondent's current occupational status

association, in that both are related to family background. Although the pattern is not so regular, men with very short intervals similarly appear to be disadvantaged by low levels of father's education (V) and large numbers of siblings (T). Moreover, short intervals are associated with early entry into the job market (J), with a comparatively low status of the first job (W), and with educational levels below the general average (U). There is, however, no definite relationship between length of interval to first birth and age of the respondent (the husband) at marriage (M). In this connection, it should be remembered that the specifications of the subpopulation place certain limits on the range of variation of M.

The next step in the analysis was designed to estimate the association of the length of the interval from marriage to first birth with selected variables, net of their common dependence on the three family background factors (V, X, and T; father's education and occupation, and number of siblings). The method used here, in view of a shortage of time for carrying out the analysis, was contrived with a view toward economizing on computations at the risk of some bias in the estimates. For the entire subpopulation, we computed the regression of each of five dependent variables (Y, M, J, W, and U) on the three background variables (V, X, and T). We then substituted into these regression equations the set of means of V, X, and T for each of the intervals, as shown in the three relevant columns of Table 9.6.1. Finally, the mean of a given dependent variable in a given interval was expressed as a deviation from that expected on the basis of this calculation from the regression. Such deviations are shown in the lower panel of Table 9.6.2.

The main result of this work, apparent from a comparison of corresponding figures in the two panels of Table 9.6.2, is that the three family background factors do not fully explain the association of the several variables with interval from marriage to first birth. In terms of both gross effects and net effects, short intervals are associated with relatively low occupational status, early entry into the labor market, and low educational level. Age at marriage, however, shows no association with length of interval, either in terms of gross effects or in terms of net effects. In regard to the other four dependent variables, it is true that the net effects are not so pronounced as the gross effects. Thus, unfavorable selection on background factors for those with short intervals is part of the explanation for their unfavorable subsequent performance; but it is only part of such an explanation.

In Table 9.6.3 the same type of analysis is carried out with occupational achievement (as of 1962) as the dependent variable. The first column repeats the set of gross effects of length of interval on occupational status. In the second column, the net effects are estimated from the regression of Y on U and W, inserting into that regression the sets of means on these two variables for the several categories of interval from marriage to first birth. Evidently, a substantial part of the association of Y with length of interval is bound up with the

Table 9.6.2.--Deviations of Means, by Interval from Marriage to First Birth, from Grand Mean (Gross Effects) and from Values Expected from Regression on Background Factors V, X, T (Net Effects), for Selected Variables Taken from Table 9.6.1

Interval	Dependent Variable				
	1962 occ. (Y)	Age at mar. (M)	Age at first job (J)	First job (W)	Educ. (U)
<b>GROSS EFFECTS</b>					
Under 6 months	-7.3	0.0	-0.7	-4.5	-0.9
6 to 8 months	-4.6	-0.6	-0.4	-5.6	-0.5
9 to 11 months	-3.3	0.0	-0.2	-1.6	-0.1
12 to 14 months	-2.1	0.6	-0.1	-2.7	-0.2
15 to 20 months	2.0	-0.1	0.2	1.9	0.1
21 to 26 months	1.2	0.0	0.1	-0.5	0.2
27 to 35 months	5.5	0.2	0.4	4.6	0.6
3 years	5.4	0.3	0.5	4.4	0.5
4 or 5 years	4.1	0.0	0.2	2.7	0.6
6 years or more	-0.9	-0.5	-0.2	3.9	-0.1
<b>NET EFFECTS</b>					
Under 6 months	-4.5	0.1	-0.4	-2.4	-0.5
6 to 8 months	-2.1	-0.6	-0.1	-3.3	-0.1
9 to 11 months	-3.1	0.0	-0.2	-1.3	-0.1
12 to 14 months	-1.8	0.6	-0.1	-2.4	-0.1
15 to 20 months	1.4	-0.2	0.1	1.4	-0.2
21 to 26 months	1.2	0.0	0.2	-0.3	0.2
27 to 35 months	4.3	0.1	0.3	3.6	0.4
3 years	3.4	0.2	0.2	2.6	0.1
4 or 5 years	2.5	0.0	0.0	1.2	0.3
6 years or more	-0.1	-0.5	-0.1	4.4	0.0

Table 9.6.3.--Gross and Net Effects of Interval from Marriage to First Birth on Occupational Status in 1962 (Y), for Special OCG Subpopulation

Interval	Gross Effects	Effects, Net of Variables:*				
		U,W	U,W,J,M	V,X,T	V,X,T,U	7 vars.
Under 6 months	-7.3	-2.5	-2.7	-4.5	-2.2	-2.2
6 to 8 months	-4.6	-0.8	-0.5	-2.1	-1.4	-0.2
9 to 11 months	-3.3	-2.3	-2.3	-3.1	-2.6	-2.4
12 to 14 months	-2.1	-0.6	-0.9	-1.8	-1.2	-0.9
15 to 20 months	2.0	1.6	1.8	1.4	2.2	1.7
21 to 26 months	1.2	0.7	0.8	1.2	0.3	0.7
27 to 35 months	5.5	1.9	1.9	4.3	2.4	1.8
3 years	5.4	2.3	2.2	3.4	2.7	2.0
4 or 5 years	4.1	1.2	1.2	2.5	1.1	1.0
6 years or more	-0.9	-1.8	-1.7	-0.1	-0.1	-1.3

\*See list in Table 9.6.1.



fact that short intervals imply unfavorable values of educational attainment and status of first job. It is important to note that the second column, which estimates the influence of interval length on occupational achievement net of education and first job, does not depend for its validity on any assumption as to the temporal order in which first job, educational attainment, and first birth occur--although, to be sure, it would be of interest to clarify the effects of contingencies with respect to the ordering of such variables. Despite the strong overlap of the effects of interval length and those of education and first job, the net effects of the former remain unmistakable, essentially recapitulating the pattern already observed: short intervals are unfavorable for occupational success, and very long intervals are apparently also unfavorable, with the optimum interval being in the neighborhood of three years.

There is no need to comment in detail on the remaining columns of Table 9.6.3. A comparison of the second with the last column indicates that the net effects of length of interval are much the same, whether only U and W or all the antecedent variables (U, W, J, M, T, X, and V) are taken into account.

While the analysis has emphasized the clear patterning of the apparent influence of interval length on occupational achievement, we should not conclude the discussion without remarking on the need for perspective in interpreting the magnitude of this influence. Looking at the pattern of net effects in Table 9.6.3, we see that at most 5 points on the occupation scale can be assigned to the variation between the shortest and the optimum intervals, net of the influence of first job and education.

## CHAPTER 10

### CONCLUSIONS

This chapter does not recapitulate the specific substantive findings reported and interpreted in the body of the report. The more salient results, insofar as these may be abstracted from detailed arguments concerning theory and method, are listed in the Summary at the beginning of the report. The "conclusions" to be stated here consist in the investigators' assessment of the success of the whole project, as measured against its initial and continuing objectives.

We sought to build on the results of prior research, taking into account a fairly substantial body of evidence not hitherto integrated into a systematic representation of the processes determining occupational achievement of men in contemporary American society. The notion was to treat such evidence, insofar as it was accessible in an appropriate form, as raw materials for the construction of interpretive models for which a prototype already existed in consequence of previous research. Each piece of evidence was to be considered for use in attempting an "extension" of this "basic" model. The basic model purported to interpret the association of occupational status, regarded as an "outcome" variable, with characteristics of the family of orientation, regarded as "background" factors. The extensions sought included additional outcome variables, additional background factors, and additional variables believed to mediate between these two categories. The latter, termed "intervening variables" and "career contingencies," were thought of in quite comprehensive terms. Hence, the general approach was flexible enough to accommodate all the kinds of variables suggested in the literature as germane to the process under study. The limitations on the scope of our effort were dictated primarily by the availability of data rather than by closure of the conceptual scheme. No new data were expressly collected for this project, although additional tabulations and computations from several already extant bodies of data were made on its behalf.

In one sense, the project clearly met its objectives. In the several chapters of the text numerous examples are offered of "extensions" that develop the original model, clarifying relationships implicit in it or elaborating upon it to give a fuller account of the process under study. These extensions are secured in such a way that the consistency of the several pieces of evidence with the point of view adopted

for the purpose of making an interpretation is readily ascertained. The implications of that point of view are made explicit, so that both the assumptions and the results of the work are laid open for critical inspection and, perchance, improvement by subsequent research workers.

The project also disclosed weaknesses or limitations of the type of models we were attempting to construct. Some variables of obvious relevance to the process under study are not conveniently treated as quantitative scores on an interval scale; others cannot convincingly be located in a causal sequence with respect to the variables in the basic model; and still others appear to be involved in relationships that are not adequately represented by systems of linear equations assuming additive effects. When confronted with these kinds of difficulties, we have adopted modes of analysis that are less compact and elegant than those suited to the easier parts of the problem. No doubt such improvisation would have to be resorted to more and more frequently with further progress in observation and measurement. In the end, we may question whether the causal diagrams and linear equation systems featured in this research can represent the ultimate form of our accumulating knowledge in this area. The use of such models, however, can be an invaluable adjunct to inquiry in our present state of knowledge, where one is as often impressed by an investigator's inability to organize his material as by his difficulties in effecting appropriate measurement.

There is, therefore, no reason to be unduly modest. The models exhibited here do represent an increment of improvement over the schemes, formalisms, and patterns of analysis available in earlier research. That they will, in turn, be superseded by improved models--perhaps by models cast into a radically different form--is not only to be expected, it is also devoutly to be desired. In the meantime, we feel that much further useful work can be done along the lines indicated here. Some four dissertations in progress are listed in Appendix A as illustrations of the kind of further advance that may be anticipated in the near future.

Some readers will undoubtedly be disappointed that the new models exhibited here do not result in major increments to the amount of variance "explained" by comparison with the basic model of occupational achievement with which we began. It is implicit in the discussion by Lipset and Bendix (1959, Chapter IX) that a systematic consideration of "Intelligence and Motivation," in juxtaposition with the several sociological variables implicated in the process of stratification, should result in a more nearly complete "explanation" of occupational mobility. Our substantial effort to treat such variables systematically implies agreement with the spirit of their discussion. We were not, however, concerned to move the coefficient of determination much closer toward the asymptote of unity. Instead, we expected to achieve a more thorough understanding of relationships that were already well established, and thus to secure an improved "explanation" in a sense rather different from that conveyed by the magnitude of the multiple correlation. The final judgment of our success is, of course, to be made by the reader;

but we would ask that he take as his criterion the cogency of the models and the arguments supporting them rather than the purely statistical norm. There are reasons for believing--indeed, for hoping, in our capacities as members of a relatively open society--that nothing like "complete" explanation of occupational achievement will be secured with variables of the kind we now know how to measure. But there is still a long way to go in providing a consistent and convincing structure for the knowledge we already have.

## REFERENCES

- Alexander, C. Norman, Jr., and Ernest Q. Campbell. 1964. Peer Influences on Educational Aspirations and Attainments, American Sociological Review, 29: 568-575.
- Anastasi, Anne. 1956. Intelligence and Family Size, Psychological Bulletin, 53: 187-209.
- Atkinson, John W. 1957. Motivational Determinants of Risk-taking Behavior, Psychological Review, 64: 359-372.
- Atkinson, John W. (ed.). 1958. Motives in Fantasy, Action, and Society, Princeton: Van Nostrand.
- Atkinson, John W. 1964. Introduction to Motivation, Princeton: Van Nostrand.
- Benson, Viola E. 1942. The Intelligence and Later Scholastic Success of Sixth-grade Pupils, School and Society, 55: 163-167.
- Blalock, H. M., Jr. 1962-63. Four-variable Causal Models and Partial Correlation, American Journal of Sociology, 68: 182-194; 510-512.
- Blalock, H. M., Jr. 1964. Causal Inferences in Nonexperimental Research, Chapel Hill: University of North Carolina Press.
- Blau, Peter M., and Otis Dudley Duncan. 1967. The American Occupational Structure, New York: Wiley.
- Bloom, B. S. 1964. Stability and Change in Human Characteristics, New York: Wiley.
- Bordua, David J. 1960. Educational Aspirations and Parental Stress on College, Social Forces, 38: 262-269.
- Brownlee, K. A. 1960. Statistical Theory and Methodology in Science and Engineering, New York: Wiley.
- Burt, C. 1947. Family Size, Intelligence, and Social Class, Population Studies, 1: 177-186.

- Byrns, Ruth, and V. A. C. Henmon. 1936. Parental Occupation and Mental Ability, Journal of Educational Psychology, 27: 284-291.
- Campbell, Ernest Q., and C. Norman Alexander. 1965. Structural Effects and Interpersonal Relationships, American Journal of Sociology, 71: 284-289.
- Carlsson, Gösta. 1958. Social Mobility and Class Structure, Lund: CWK Gleerup.
- Centers, Richard. 1948. Motivational Aspects of Occupational Stratification, Journal of Social Psychology, 28: 187-217.
- Centers, Richard. 1949. The Psychology of Social Classes, Princeton: Princeton University Press.
- Cowden, Dudley J. 1952. The Multiple-partial Correlation Coefficient, Journal of the American Statistical Association, 47: 442-456.
- Crockett, Harry J., Jr. 1962. The Achievement Motive and Differential Occupational Mobility in the United States, American Sociological Review, 27: 191-204.
- Crockett, Harry J., Jr. 1966. Psychological Origins of Mobility, in Smelser and Lipset (1966).
- Duncan, Beverly. 1965. Family Factors and School Dropout: 1920-1960, Final Report, Cooperative Research Project No. 2258, U.S. Office of Education, Ann Arbor: The University of Michigan.
- Duncan, Beverly. 1967. Education and Social Background, American Journal of Sociology, 72: 363-372.
- Duncan, Otis Dudley. 1961a. A Socioeconomic Index for All Occupations, chapter 6 in Reiss and others (1961).
- Duncan, Otis Dudley. 1961b. Occupational Components of Educational Differences in Income, Journal of the American Statistical Association, 56: 783-792.
- Duncan, Otis Dudley. 1965. The Trend of Occupational Mobility in the United States, American Sociological Review, 30: 491-498.
- Duncan, Otis Dudley. 1966. Path Analysis: Sociological Examples, American Journal of Sociology, 72: 1-16.
- Duncan, Otis Dudley. 1967. Discrimination against Negroes, Annals of the American Academy of Political and Social Science, 371: 85-103.

- Duncan, Otis Dudley, and Robert W. Hodge. 1963. Education and Occupational Mobility, American Journal of Sociology, 67: 629-644.
- Eckland, Bruce K. 1964. College Dropouts Who Came Back, Harvard Educational Review, 34: 402-420.
- Empey, LaMar T. 1956. Social Class and Occupational Aspiration: A Comparison of Absolute and Relative Measurement, American Sociological Review, 21: 703-709.
- Erlenmeyer-Kimling, L., and Lissy F. Jarvik. 1963. Genetics and Intelligence: A Review, Science, 142: 1477-1479.
- Fisher, R. A. 1946. Statistical Methods for Research Workers, tenth edition, Edinburgh: Oliver & Boyd.
- Fox, Karl A., and James F. Cooney, Jr. 1954. Effects of Intercorrelation upon Multiple Correlation and Regression Measures, Washington: Agricultural Marketing Service, U.S. Department of Agriculture (processed).
- Freedman, Deborah S. 1963. The Relation of Economic Status to Fertility, American Economic Review, 53: 414-426.
- Freedman, Ronald, and Lolagene Coombs. 1966. Childspacing and Family Economic Position, American Sociological Review, 31: 631-648.
- Glass, David V. (ed.). 1954. Social Mobility in Britain, London: Routledge and Kegan Paul.
- Haller, A. O., and C. E. Butterworth. 1960. Peer Influences on Levels of Occupational and Educational Aspiration, Social Forces, 38: 289-295.
- Haller, Archibald O., and Irwin W. Miller. 1963. The Occupational Aspiration Scale: Theory, Structure and Correlates, Technical Bulletin No. 288, East Lansing: Agricultural Experiment Station, Michigan State University.
- Halsey, A. H., Jean Floud, and C. A. Anderson (eds.). 1961. Education, Economy, and Society, Glencoe, Ill.: Free Press.
- Hamel, Harvey R. 1967. Moonlighting--An Economic Phenomenon, Special Labor Force Report No. 90 (reprinted from Monthly Labor Review, October 1967).
- Harrell, Thomas W., and Margaret S. Harrell. 1945. Army General Classification Test Scores for Civilian Occupations, Educational and Psychological Measurement, 5: 229-239.

- Herriott, Robert E., and Nancy Hoyt St. John. 1966. Social Class and the Urban School, New York: Wiley.
- Hodge, Robert W. 1966. Occupational Mobility as a Probability Process, Demography, 3: 19-34.
- Hodge, Robert W., and others. 1964. Occupational Prestige in the United States, 1925-1963, American Journal of Sociology, 70: 286-302.
- Hodge, Robert W., and Donald J. Treiman. 1968. Class Identification in the United States, American Journal of Sociology, 73: 535-547.
- Hyman, Herbert H. 1953. The Value System of Different Classes: A Social Psychological Contribution to the Analysis of Stratification, in S. M. Lipset and R. Bendix (eds.), Class, Status, and Power, Glencoe, Ill.: Free Press.
- Kahl, Joseph A. 1953. Educational and Occupational Aspirations of "Common Man" Boys, Harvard Educational Review, 23: 186-203.
- Kahl, Joseph A. 1965. Some Measurements of Achievement Motivation, American Journal of Sociology, 70: 669-681.
- Klassen, Albert D., Jr. 1966. Military Service in American Life Since World War II: An Overview, Report No. 117, National Opinion Research Center, University of Chicago.
- Lenski, Gerhard, 1963. The Religious Factor, Garden City, N.Y.: Anchor Books, Doubleday and Co. (first published in 1961).
- Lipset, S. M., and Reinhard Bendix. 1959. Social Mobility in Industrial Society, Berkeley: University of California Press.
- McClelland, David C., et al. 1953. The Achievement Motive, New York: Appleton-Century-Crofts.
- McClelland, David C. 1961. The Achieving Society, Princeton: Van Nostrand.
- McTavish, Donald G. 1964. A Method for More Reliably Coding Detailed Occupations into Duncan's Socio-economic Categories, American Sociological Review, 29: 402-406.
- Morgan, James N., and others. 1962. Income and Welfare in the United States, New York: McGraw-Hill.
- Nisbet, J. D. 1953. Family Environment and Intelligence, Eugenics Review, 45: 31-40.



- Reiss, Albert J., Jr., and others. 1961. Occupations and Social Status, New York: Free Press of Glencoe.
- Reissman, Leonard. 1953. Levels of Aspiration and Social Class, American Sociological Review, 18: 233-242.
- Rhodes, Albert Lewis, Albert J. Reiss, Jr., and Otis Dudley Duncan. 1965. Occupational Segregation in a Metropolitan School System, American Journal of Sociology, 70: 682-694, and 71: 131.
- Rogoff, Natalie. 1961. Local Social Structure and Educational Selection, in Halsey, Floud, and Anderson (1961).
- Rosen, Bernard C., and D'Andrade, Roy. 1959. The Psychological Origins of Achievement Motivation, Sociometry, 22: 185-218.
- Sewell, William H., and J. Michael Armer. 1966. Neighborhood Context and College Plans, American Sociological Review, 31: 159-168.
- Sewell, William H., and Vimal P. Shah. 1967. Socioeconomic Status, Intelligence, and the Attainment of Higher Education, Sociology of Education, 40: 1-23.
- Sexton, Patricia C. 1961. Education and Income, New York: Viking.
- Simpson, Richard L. 1962. Parental Influence, Anticipatory Socialization, and Social Mobility, American Sociological Review, 27: 517-522.
- Smelser, N. J., and S. M. Lipset (eds.). 1966. Social Structure and Mobility in Economic Development, Chicago: Aldine.
- Stacey, B. G. 1965. Some Psychological Aspects of Inter-Generation Occupational Mobility, British Journal of Social and Clinical Psychology, 4: 275-286.
- Stephenson, Richard M. 1957. Mobility Orientation and Stratification of 1,000 Ninth Graders, American Sociological Review, 22: 204-212.
- Stewart, Naomi. 1947. A.G.C.T. Scores of Army Personnel Grouped by Occupation, Occupations, 26: 5-24.
- Svalastoga, Kaare. 1959. Prestige, Class and Mobility, Copenhagen: Gyldendal.
- Svalastoga, Kaare. 1965. Social Differentiation, New York: David McKay Co.
- Terman, Lewis M. 1925. Genetic Studies of Genius, Vol. I, Mental and Physical Traits of a Thousand Gifted Children, Stanford: Stanford University Press.

- Thorndike, R. L. 1942. Two Screening Tests of Verbal Intelligence, Journal of Applied Psychology, 26: 128-135.
- Thorndike, R. L., and G. Gallup. 1944. Verbal Intelligence of the American Adult, Journal of General Psychology, 30: 75-85.
- Turner, Ralph H. 1964. The Social Context of Ambition, San Francisco: Chandler Pub. Co.
- Tyler, Leona E. 1964. Work and Individual Differences, in Henry Borow (ed.), Man in a World at Work, Boston: Houghton Mifflin Co.
- U.S. Bureau of Employment Security. 1962. Guide to the Use of the General Aptitude Test Battery, Section III, Development, Washington: U.S. Department of Labor.
- Westoff, Charles F., Robert G. Potter, Jr., Philip C. Sagi, and Elliot G. Mishler. 1961. Family Growth in Metropolitan America, Princeton: Princeton University Press.
- Wilson, Alan B. 1959. Residential Segregation of Social Classes and Aspirations of High School Boys, American Sociological Review, 24: 836-845.
- Winterbottom, Marian R. 1958. The Relation of Need for Achievement to Learning Experiences in Independence and Mastery, in Atkinson (1958).
- Wright, Sewall. 1931. Statistical Methods in Biology, Journal of the American Statistical Association, 26 (suppl.): 155-163.
- Wright, Sewall. 1960a. Path Coefficients and Path Regressions: Alternative or Complementary Concepts? Biometrics, 16: 189-202.
- Wright, Sewall. 1960b. The Treatment of Reciprocal Interaction, with or without Lag, in Path Analysis, Biometrics, 16: 423-445.

## APPENDIX A

### PUBLICATIONS AND SPINOFF

The output of the project, narrowly construed, consists of the present report and the papers prepared for separate publication that are listed in section A.1. It is never possible to draw the boundaries of a project with precision, however; and in the case of the present project several pieces of work being conducted concurrently drew inspiration and in some cases results from the project. Relevant items are listed in section A.2. In addition, certain of the topics dealt with in the project or closely related thereto have been selected as subjects for doctoral dissertations. Four dissertations in various stages can be rather definitely linked to the project by virtue of the association of their authors with it or in view of an explicit intention to extend the models considered here. These dissertations are listed in section A.3.

#### A.1. List of Project Reports Prepared for Separate Publication

1. Otis Dudley Duncan, "Path Analysis: Sociological Examples," American Journal of Sociology, 72 (July 1966), 1-16.
2. Otis Dudley Duncan and James D. Cowhig, "Social Backgrounds and Occupational Commitment of Male Wageworkers in Agriculture," Agricultural Economics Research, 18 (October 1966), 129-135.
3. Otis Dudley Duncan, "Ability and Achievement," Eugenics Quarterly, 15 (March 1968), 1-11.
4. Otis Dudley Duncan, "Patterns of Occupational Mobility among Negro Men," Demography, 4 (in press).
5. Otis Dudley Duncan, "Contingencies in Constructing Causal Models: An Illustration," Sociological Methodology: 1968, in press.
6. Otis Dudley Duncan, "Inheritance of Poverty or Inheritance of Race?" in forthcoming symposium of the Poverty Seminar sponsored by American Academy of Arts and Sciences, edited by Daniel P. Moynihan.

7. Otis Dudley Duncan, Archibald O. Haller, and Alejandro Portes, "Peer Influences on Aspirations: A Re-interpretation," American Journal of Sociology, in press.

8. Beverly Duncan and Otis Dudley Duncan, "Minorities and the Process of Stratification," American Sociological Review, in press.

9. Beverly Duncan and Otis Dudley Duncan, "Family Stability and Occupational Success," Social Problems, in press.

#### A.2. Spinoff: Related Work

1. A document entitled "Opportunity" was drafted by Otis Dudley Duncan as a contribution to the work of the Panel on Social Measurements appointed by the Secretary of Health, Education, and Welfare and serving during 1966-1968. The document includes some summaries of material developed in this project as well as a review of related information.

2. A chapter entitled "Social Stratification and Mobility: Problems in the Measurement of Trend" was contributed by Otis Dudley Duncan to a symposium entitled, Indicators of Social Change: A Symposium on Concepts and Measures. This symposium was sponsored by the Russell Sage Foundation and the volume is to be published under the editorship of Eleanor Bernert Sheldon and Wilbert E. Moore.

3. A chapter entitled "Trends in Output and Distribution of Schooling" was contributed by Beverly Duncan to the symposium mentioned in the preceding item.

4. A paper on "Discrimination against Negroes" (O. D. Duncan, 1967) includes some data based on the OCG data set and discusses the function of models of the socioeconomic life cycle in the analysis of social indicators.

5. A memorandum on "Social Stratification" was prepared by Otis Dudley Duncan for the Survey of the Behavioral and Social Sciences, which is sponsored by the National Academy of Sciences and the Social Science Research Council.

#### A.3. Dissertations Related to the Project

1. Robert M. Hauser, "Individual, School, and Neighborhood Factors in Educational Outcomes in a Metropolitan School System"; prospectus submitted April 1967, completion expected summer 1968. (Mr. Hauser has not participated directly in the project, but has been in close touch with it for its entire duration and has chosen a topic that arises in connection with one of the types of extension of our basic model.)

2. Bruce L. Warren, "The Role of Religion and Religious Group Identification in Socio-economic Achievements of Americans"; prospectus submitted June 1967, completion expected summer 1968. (Mr. Warren was a research assistant on this project during its first year.)

3. James N. Porter, "Demographic and Social-psychological Influences on Educational and Occupational Development: An Attempt at Integration"; prospectus submitted April 1968, completion expected summer 1969. (Mr. Porter is a Ph.D. candidate at Duke University who visited the University of Michigan in the summer of 1967 and served as research assistant on this project at that time.)

4. David L. Featherman, "Social and Psychological Factors in the Process of Occupational and Economic Achievement among American Fathers," prospectus submitted May 1968, completion expected summer of 1969. (Mr. Featherman has been a research assistant and collaborator on this project throughout its term; his dissertation contemplates an additional series of extensions of the basic model making use of data that became available as the project came to a close.)

## APPENDIX B

### SUPPLEMENTARY TABLES

Tables B.1--B.8 present correlation matrices for selected sub-populations covered by the OCG survey. Some of these correlations have been analyzed intensively in the text; others were not used in any of the formal models presented there. It is thought that some readers may wish to inspect more closely certain of the relationships suggested by the OCG data but not treated in detail in the text.

Each table gives the matrix of correlations among nine variables. The variables are defined as follows:

- V: Educational attainment (years of school completed) by the respondent's father or other person who was the head of the family in which the respondent grew up.
- X: Socioeconomic score of the occupation of the father (or other family head) as of the respondent's age 16.
- T: Number of siblings (brothers plus sisters) of the respondent, including stepbrothers and sisters and children adopted by respondent's parents, and including siblings born alive but no longer living.
- E: Educational attainment (years of school completed) by respondent's oldest brother (if respondent had at least one older brother who lived to age 25).
- U: Educational attainment (years of school completed) by respondent. Cases in which educational attainment was not reported were allocated by Bureau of the Census imputation procedures.
- W: Socioeconomic score of respondent's "first full-time job you had after you left school. (Do not count part-time jobs or jobs during school vacation. Do not count military service.)"
- J: Respondent's age upon beginning first job, as defined for W.
- M: Respondent's age at first marriage (defined only for ever-married men).

**Y:** Socioeconomic score of respondent's current occupation as of March 1962, or last previous occupation for the experienced unemployed. Cases with occupation not reported were allocated by Bureau of the Census imputation procedures. Socioeconomic scores are not defined for members of the civilian labor force currently unemployed whose last occupation was member of the Armed Forces.

Each correlation was computed on the basis of all cases reporting both variables. The entries below the diagonal in each table refer to the percentages reporting the specified combinations. Some approximations are involved here. The base, 100 per cent, was taken to be the number reporting both U and Y, since the restriction of the universe to members of the experienced civilian labor force meant that all men had a reportable occupation, and the use of imputation for U and Y meant that there were no nonresponses in the tabulations. However, as indicated above, Y is not defined for former members of the Armed Forces who have not subsequently taken a civilian job. Hence the number reporting Y may be slightly smaller than the total number included in the tabulation. This is signified by showing the total reporting Y as "100-" per cent. Another approximation is involved in estimating the proportion reporting combinations of T with other variables. The correlations here were built up from separate data on number of brothers and number of sisters by the other variables, along with number of brothers by number of sisters. Errors incurred in these approximations are believed to be quite small, since there was little nonresponse on number of brothers or sisters.

The means and standard deviations are those computed for the data in the cross-tabulation of the given variable by variable U, or, in the case of the latter, the cross-tabulation of U by variable Y. Because of selective nonresponse, these are not necessarily the same as the means and standard deviations occurring in a given correlation problem. For the most part, differences appear to be minor for the purposes of the analyses conducted here. For the two variables not defined for the whole population (E and M), however, the slippage could assume greater proportions. In connection with variable M, incidentally, the user should remember that the distribution of M is affected by the age limits on the subpopulation; among men 25 to 34 years old, for example, no man could have reported an age at marriage of 35 or over.

Further explanations of the OCG data will be found in Blau and Duncan (1967). However, some of the variables used here were not employed in that study, and the tabulation scheme devised for the present project involved some variations on the one followed there.

Table B.1.--Correlation Matrix from OCG Data on Native Non-Negro Men, 25 to 64 Years Old, in the Experienced Civilian Labor Force: March 1962  
 [Below diagonal: Per Cent Reporting Combination of Variables]

Variable	Variable										
	V	X	T	E	U	W	J	M	Y		
Father's education	V	.494	-.292	.465	.418	.328	.250	.017	.321		
Father's occupation	X	85	-.278	.412	.432	.412	.248	.043	.404		
Siblings	T	88	...	-.314	-.351	-.265	-.160	-.008	-.261		
Brother's education	E	45	50	...	.573	.371	.256	.026	.401		
Education	U	90	93	98	50	.554	.449	.080	.606		
First job	W	88	91	96	49	98	.442	.092	.534		
Age at first job	J	87	89	95	48	94	...	.092	.311		
Age married	M	81	85	90	45	89	87	...	.072		
Occupation	Y	89	93	98	50	97	96	91	...		
% reporting*		90	93	98	50	98	96	91	100-		
Mean		8.18	28.0	4.30	10.33	27.1	18.5	24.3	39.6		
Standard deviation		3.54	21.3	3.11	3.38	21.3	3.2	4.9	24.5		

\*100% represents 31,133,000 men based on about 14,347 sample cases.



Table B.2.--Correlation Matrix from OCG Data on Native Non-Negro Men, with Nonfarm Background, 25 to 64 Years Old, in the Experienced Civilian Labor Force: March 1962  
 [Below diagonal: Per Cent Reporting Combination of Variables]

Variable	Variable										
	V	X	T	E	U	W	J	M	Y		
Father's education	V	.506	-.275	.449	.393	.322	.285	.022	.306		
Father's occupation	X	84	...	-.237	.403	.376	.297	.062	.371		
Siblings	T	89	...	-.310	-.327	-.250	-.206	-.012	-.254		
Brother's education	E	43	47	...	.546	.357	.315	.041	.392		
Education	U	90	98	47	...	.554	.518	.100	.610		
First job	W	88	96	46	97	...	.485	.117	.526		
Age at first job	J	88	96	46	98	96	...	.101	.348		
Age married	M	81	90	42	91	88	88	...	.095		
Occupation	Y	90	98	47	100 <sup>-</sup>	97	97	90	...		
% reporting*		90	91	47	100	97	98	91	100 <sup>-</sup>		
Mean		8.63	34.1	3.85	10.91	11.70	18.5	24.3	43.5		
Standard deviation		3.67	22.7	2.94	3.37	22.1	3.2	4.9	24.6		

\*100% represents 22,638,000 men based on about 10,432 sample cases.

Table B.3.--Correlation Matrix from OCG Data on Native Negro Men, 25 to 64 Years Old, in the Experienced Civilian Labor Force: March 1962  
 [Below diagonal: Per Cent Reporting Combination of Variables]

Variable	Variable										
	V	X	T	E	U	W	J	M	Y		
Father's education	V	.354	-.105	.397	.363	.230	.160	-.044	.226		
Father's occupation	X	69	...	-.113	.241	.143	.176	.009	.151		
Siblings	T	80	...	-.079	-.178	-.075	-.112	-.004	-.102		
Brother's education	E	42	42	...	.528	.267	.147	-.119	.203		
Education	U	81	81	100 <sup>-</sup>	...	.271	.314	.029	.410		
First job	W	76	76	92	94	...	.127	-.026	.329		
Age at first job	J	76	75	91	92	89	...	-.007	.148		
Age married	M	71	72	90	91	83	81	...	.076		
Occupation	Y	80	80	99	100 <sup>-</sup>	92	90	89	...		
% reporting*		81	81	100 <sup>-</sup>	100	94	92	91	100 <sup>-</sup>		
Mean		6.31	16.1	5.58	8.18	14.9	17.7	24.3	17.7		
Standard deviation		3.30	12.9	3.74	3.42	12.7	3.9	5.8	15.3		

\*100% represents 3,024,000 men based on about 1,394 sample cases.

Table B.4.--Correlation Matrix from OCG Data on Native Negro Men, with Nonfarm Background, 25 to 64 Years Old, in the Experienced Civilian Labor Force: March 1962  
[Below diagonal: Per Cent Reporting Combination of Variables]

Variable	Variable										
	V	X	T	E	U	W	J	M	Y		
Father's education	V	.396	-.064	.355	.358	.209	.173	-.081	.221		
Father's occupation	X		-.105	.184	.207	.106	.236	.000	.118		
Siblings	T	68		-.042	-.171	-.058	-.158	.008	-.093		
Brother's education	E	31	43		.459	.211	.094	-.186	.166		
Education	U	77	100-	43		.240	.346	.002	.413		
First job	W	72	90	39	92		.150	-.066	.312		
Age at first job	J	74	92	41	93	89		-.008	.162		
Age married	M	67	89	37	90	81	82		.045		
Occupation	Y	76	99	43	100-	90	92	89			
% reporting*		77	68	43	100	92	93	90	100-		
Mean		6.94	19.0	4.86	9.36	16.7	17.9	24.3	19.7		
Standard deviation		3.39	17.2	3.58	3.39	14.4	3.9	5.8	16.9		

\*100% represents 1,870,000 men based on about 862 sample cases.

Table B.5.--Correlation Matrix from OCG Data on Native Non-Negro Men, with Nonfarm Background, 25 to 34 Years Old, in the Experienced Civilian Labor Force: March 1962  
 [Below diagonal: Per Cent Reporting Combination of Variables]

Variable	Variable									
	V	X	T	E	U	W	J	M	Y	
Father's education	V	.489	-.269	.419	.402	.315	.339	.123	.342	
Father's occupation	X	88	-.229	.379	.413	.371	.330	.116	.353	
Siblings	T	93	...	-.310	-.326	-.268	-.231	-.081	-.247	
Brother's education	E	44	47	...	.536	.353	.318	.184	.391	
Education	U	94	97	47	...	.586	.618	.272	.651	
First job	W	92	95	46	97	...	.593	.215	.578	
Age at first job	J	93	96	46	98	96	...	.251	.453	
Age married	M	80	84	41	86	83	84	...	.218	
Occupation	Y	94	97	47	100 <sup>-</sup>	97	97	85	...	
% reporting*		94	97	47	100	97	98	86	100 <sup>-</sup>	
Mean		9.17	34.6	3.49	11.75	12.38	18.9	22.2	43.3	
Standard deviation		3.53	22.4	2.86	3.23	23.2	2.9	3.1	25.0	

\*100% represents 6,815,000 men based on about 3,141 sample cases.

Table B.6.--Correlation Matrix from OCG Data on Native Non-Negro Men, with Nonfarm Background, 35 to 44 Years Old, in the Experienced Civilian Labor Force: March 1962  
 [Below diagonal: Per Cent Reporting Combination of Variables]

Variable	Variable										
	V	X	T	E	U	W	J	M	Y		
Father's education	V	.530	-.287	.454	.405	.340	.280	.052	.319		
Father's occupation	X	84	...	-.248	.440	.366	.293	.060	.390		
Siblings	T	89	90	...	-.338	-.261	-.186	-.033	-.275		
Brother's education	E	44	44	48	...	.506	.338	.068	.403		
Education	U	90	91	98	48	...	.545	.136	.643		
First job	W	88	89	96	48	97	...	.091	.494		
Age at first job	J	88	89	96	48	98	96	.121	.342		
Age married	M	84	85	92	44	94	91	...	.057		
Occupation	Y	90	91	98	48	100-	97	93	...		
% reporting*		90	91	98	48	100	97	94	100-		
Mean		8.55	34.4	3.77	11.09	11.95	29.9	18.8	24.0	44.8	
Standard deviation		3.72	23.1	2.88	3.17	3.20	21.8	3.0	4.1	24.7	

\*100% represents 6,974,000 men based on about 3,214 sample cases.

Table B.7.--Correlation Matrix from OCG Data on Native Non-Negro Men, with Nonfarm Background, 45 to 54 Years Old, in the Experienced Civilian Labor Force: March 1962  
 [Below diagonal: Per Cent Reporting Combination of Variables]

Variable	Variable									
	V	X	T	E	U	W	J	M	Y	
Father's education	V	.486	-.239	.438	.369	.308	.226	-.006	.252	
Father's occupation	X	82	-.230	.381	.445	.387	.248	.023	.378	
Siblings	T	87	...	-.247	-.300	-.205	-.162	-.019	-.234	
Brother's education	E	41	45	...	.542	.338	.207	.029	.397	
Education	U	88	98	45	...	.556	.412	.108	.595	
First job	W	87	97	44	98	...	.346	.077	.512	
Age at first job	J	87	97	44	98	97	...	.104	.252	
Age married	M	81	91	41	92	90	90	...	.058	
Occupation	Y	88	98	45	100 <sup>-</sup>	98	98	92	...	
% reporting*		88	98	45	100	98	98	92	100 <sup>-</sup>	
Mean		8.15	4.09	10.33	11.26	28.8	18.3	25.7	42.4	
Standard deviation		3.70	2.96	3.33	3.29	21.2	3.3	5.4	23.8	

\*100% represents 5,633,000 men based on about 2,596 sample cases.

Table B.8.--Correlation Matrix from OCG Data on Native Non-Negro Men, with Nonfarm Background, 55 to 64 Years Old, in the Experienced Civilian Labor Force: March 1962  
 [Below diagonal: Per Cent Reporting Combination of Variables;

Variable	Variable									
	V	X	T	E	U	W	J	M	Y	
Father's education	V	.531	-.275	.504	.353	.302	.275	.077	.302	
Father's occupation	X	75	-.240	.479	.388	.394	.326	.107	.354	
Siblings	T	82	...	-.263	-.282	-.253	-.204	-.068	-.257	
Brother's education	E	40	47	...	.539	.465	.394	.217	.439	
Education	U	83	98	47	...	.557	.491	.207	.558	
First job	W	81	96	46	98	...	.498	.220	.505	
Age at first job	J	81	96	46	98	96	...	.157	.335	
Age married	M	77	92	44	93	90	90	...	.141	
Occupation	Y	82	98	47	100-	97	97	92	...	
% reporting*		83	98	47	100	98	98	93	100-	
Mean		8.38	4.46	9.72	10.47	30.4	17.7	26.2	42.7	
Standard deviation		3.66	3.09	3.62	3.61	21.5	3.7	6.5	24.6	

\*100% represents 3,216,000 men based on about 1,482 sample cases.

**ERIC REPORT RESUME**

(TOP)  
001  
100  
101  
102  
103  
200  
300  
310  
320  
330  
340  
350  
400  
500  
501  
600  
601  
602  
603  
604  
605  
606  
607  
800  
801  
802  
803  
804  
805  
806  
807  
808  
809  
810  
811  
812  
813  
814  
815  
816  
817  
818  
819  
820  
821  
822

ERIC ACCESSION NO.		RESUME DATE 05-31-68		P.A.	T.A.	IS DOCUMENT COPYRIGHTED? YES <input type="checkbox"/> NO <input checked="" type="checkbox"/>	ERIC REPRODUCTION RELEASE? YES <input checked="" type="checkbox"/> NO <input type="checkbox"/>
CLEARINGHOUSE ACCESSION NUMBER							
TITLE Final Report, Project No. 5-0074 (EO-191), Contract No. OE-5-85-072 Socioeconomic Background and Occupational Achievement: Extensions of a Basic Model							
PERSONAL AUTHOR(S) Duncan, Otis Dudley, and others							
INSTITUTION (SOURCE) The Univ. of Michigan, Ann Arbor, Mich., Population Studies Center							SOURCE CODE
REPORT/SERIES NO. OTHER SOURCE							SOURCE CODE
OTHER REPORT NO. OTHER SOURCE							SOURCE CODE
OTHER REPORT NO.							
PUB'L. DATE 31-May-68		CONTRACT/GRANT NUMBER OE-5-85-072					
PAGINATION, ETC. pp. xv + 296							
RETRIEVAL TERMS Occupational achievement, socioeconomic status, process of stratification, family background, life cycle, cohort, ethnic group, race, family size, family stability, intelligence, aspirations, motivation, parental influence, peer groups, school climate, career contingencies, migration, fertility, childspacing, causal models, path analysis							
IDENTIFIERS Bureau of the Census, Occupational Changes in a Generation							
ABSTRACT The basic model of occupational achievement, derived from previous research, specifies family socioeconomic background and the intervening factor of educational attainment as influences on level of occupational status achieved. Elaborations of the basic model are undertaken to include additional background factors (national origin, race, family size and stability), more intervening variables (intelligence, aspirations and motivation, influences of significant others), various career contingencies (first job, migration, disruption of marriage, fertility and childspacing), and outcomes besides occupational status (income, subjective achievement). Primary analysis of a large national survey and secondary analysis of six other substantial bodies of data provide estimates of the relative strength of factors influencing achievement for the adult male population of the contemporary United States. Estimates are obtained for the parameters of causal models constructed by the technique of path analysis. Emphasis is placed on the synthesis of empirical results via a procedure for making systematic interpretations, rather than on the particular findings as such. The procedure, as exemplified in this research, holds promise of contributing an improved understanding of how variables combine to shape the process of achievement in American society.							