

R E P O R T R E S U M E S

ED 021 113

VT 005 696

AUTOMOTIVE DIESEL MAINTENANCE 2. UNIT XII, LEARNING ABOUT
BATTERY SERVICING AND TESTING (PART I).

HUMAN ENGINEERING INSTITUTE, CLEVELAND, OHIO

REPORT NUMBER AM-2-12

FUB DATE 7 SEP 67

EDRS PRICE MF-\$0.25 HC-\$1.76 42P.

DESCRIPTORS- *STUDY GUIDES, *TEACHING GUIDES, *TRADE AND
INDUSTRIAL EDUCATION, *AUTO MECHANICS (OCCUPATION), EQUIPMENT
MAINTENANCE, *ELECTICAL SYSTEMS, DIESEL ENGINES, ADULT
VOCATIONAL EDUCATION, TRANSPARENCIES, PROGRAMED MATERIALS,
INDIVIDUAL INSTRUCTION, INSTRUCTIONAL FILMS, MOTOR VEHICLES,
PROGRAMED INSTRUCTION,

THIS MODULE OF A 25-MODULE COURSE IS DESIGNED TO DEVELOP
AN UNDERSTANDING OF THE CONSTRUCTION AND MAINTENANCE OF
LEAD-ACID STORAGE BATTERIES USED ON DIESEL POWERED EQUIPMENT.
TOPICS ARE (1) BATTERY COMPONENTS AND CONSTRUCTION, (2)
CHEMICAL ACTION IN BATTERIES, (3) THE BATTERY AND THE
CHARGING CIRCUIT, (4) BATTERY CHARGING VOLTAGE, (5) EFFECTS
OF STATE OF CHARGE ON BATTERY CHARGING VOLTAGE AND CHARGING
RATES, (6) EFFECTS OF TEMPERATURE ON BATTERY CHARGING VOLTAGE
AND CHARGING RATES, AND (7) TERMINOLOGY. THE MODULE CONSISTS
OF A SELF-INSTRUCTIONAL PROGRAMED TRAINING FILM "AUTOMOTIVE
BATTERIES I--INTRODUCTION TO THE LEAD-ACID STORAGE BATTERY"
AND OTHER MATERIALS. SEE VT 005 685 FOR FURTHER INFORMATION.
MODULES IN THIS SERIES ARE AVAILABLE AS VT 005 685 - VT 005
709. MODULES FOR "AUTOMOTIVE DIESEL MAINTENANCE 1" ARE
AVAILABLE AS VT 005 655 - VT 006 684. THE 2-YEAR PROGRAM
OUTLINE FOR "AUTOMOTIVE DIESEL MAINTENANCE 1 AND 2" IS
AVAILABLE AS VT 006 006. THE TEXT MATERIAL, PROGRAMED
TRAINING FILM, AND THE ELECTRONIC TUTOR MAY BE RENTED (FOR
\$1.75 PER WEEK) OR PURCHASED FROM THE HUMAN ENGINEERING
INSTITUTE, HEADQUARTERS AND DEVELOPMENT CENTER, 2341 CARNEGIE
AVENUE, CLEVELAND, OHIO 44115. (HC)

AUTOMOTIVE DIESEL 2 MAINTENANCE

LEARNING ABOUT BATTERY SERVICING
AND TESTING (PART I)

UNIT XII

SECTION A	BATTERY COMPONENTS AND CONSTRUCTION
SECTION B	CHEMICAL ACTION IN BATTERIES
SECTION C	THE BATTERY AND THE CHARGING CIRCUIT
SECTION D	BATTERY CHARGING VOLTAGE
SECTION E	EFFECTS OF STATE OF CHARGE ON BATTERY CHARGING VOLTAGE AND CHARGING RATES
SECTION F	EFFECTS OF TEMPERATURE ON BATTERY CHARGING VOLTAGE AND CHARGING RATES
SECTION G	TERMINOLOGY

AM 2-12
9/7/67

U.S. DEPARTMENT OF HEALTH, EDUCATION & WELFARE
OFFICE OF EDUCATION

THIS DOCUMENT HAS BEEN REPRODUCED EXACTLY AS RECEIVED FROM THE PERSON OR ORGANIZATION ORIGINATING IT. POINTS OF VIEW OR OPINIONS STATED DO NOT NECESSARILY REPRESENT OFFICIAL OFFICE OF EDUCATION POSITION OR POLICY.

HUMAN ENGINEERING INSTITUTE

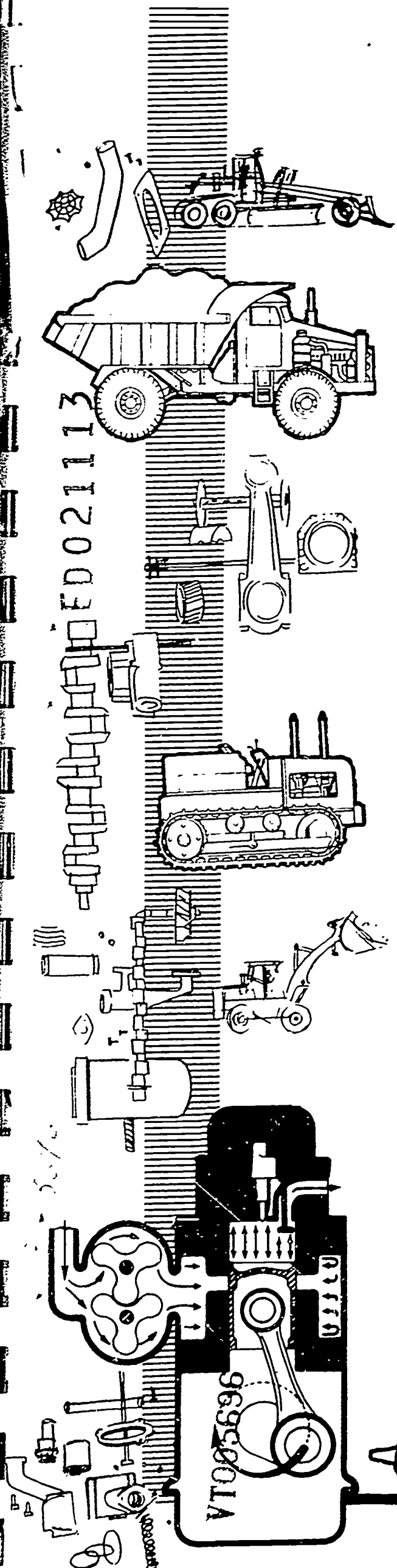

SECTION A -- BATTERY COMPONENTS AND CONSTRUCTION

The material in this unit covers the construction, theory of operation, and servicing procedures applicable to the LEAD-ACID storage battery.

The lead-acid storage battery is an electrochemical device for converting chemical energy into electrical energy. It is not a storage tank for electricity as is often thought, but instead, it stores electrical energy in chemical form.

Active materials within the battery react chemically to produce a flow of direct current whenever lights, radio, cranking motor, or other current-consuming devices are connected to the battery terminal posts. This current is produced by the chemical reaction between the active materials of the PLATES and the sulfuric acid of the ELECTROLYTE.

The battery performs three functions in automotive applications. First, it supplies electrical energy for the cranking motor (on electrically started engines) and for the ignition system on gas engines, as the engine is started. Second, it supplies current for the lights, radio, heater and other accessories when the electrical demands of these devices exceed the output of the generator or alternator. Third, the battery acts as a voltage stabilizer in the electrical system. Satisfactory operation of the vehicle is impossible unless the battery performs each of these functions.

The internal construction of an automotive type lead-acid storage battery is such that a highly reliable power source is provided.

Two types of plates, one positive and the other negative, are the basic units. These plates consist of a special chemically active material contained in cast GRIDS made of a lead-antimonial alloy. The grids are flat, rectangular lattice-like castings with fairly heavy borders and a mesh of horizontal and vertical wires. See Figure 1. Each grid is designed specifically to

hold the active materials within its borders. Once the grids have been pasted with the active materials, they are called plates. During the manufacturing process, these plates are subjected to processes which cure and transform the pasted materials into chemically active materials. The plates then are said to be "charged". Charged negative plates contain sponge lead (Pb), which is gray in color. Charged positive plates contain lead peroxide (PbO₂), which has a dark chocolate brown color.

A **PLATE GROUP** is made by lead burning (welding) a number of similar plates to a lead casting called a **PLATE STRAP**. The plate strap casting includes a vertical terminal post. Plate groups of opposite polarity are interlaced so that negative and positive plates alternate. Negative plate groups normally contain one more plate than the corresponding positive groups. This allows negative plates to occupy the exposed positions on both sides of the interlaced group. Each plate in the interlaced plate groups is kept apart from its neighbors by means of **SEPARATORS** and the resulting assembly is called an **ELEMENT**.

The separators in most batteries are thin sheets of microporous rubber which are used in both wet and dry charged batteries. The porosity of the rubber separators permits rapid diffusion of the electrolyte to the plate area. All separators have one ribbed side and are assembled with the ribs vertical and facing the positive plate. In this position the space between the ribs provides a reservoir of electrolyte to react with the positive plates. See Figure 2.

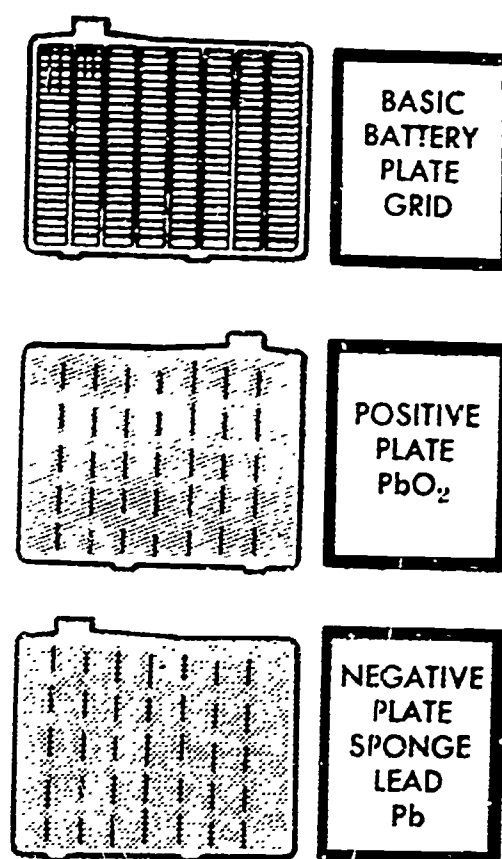

Fig. 1 Battery plates

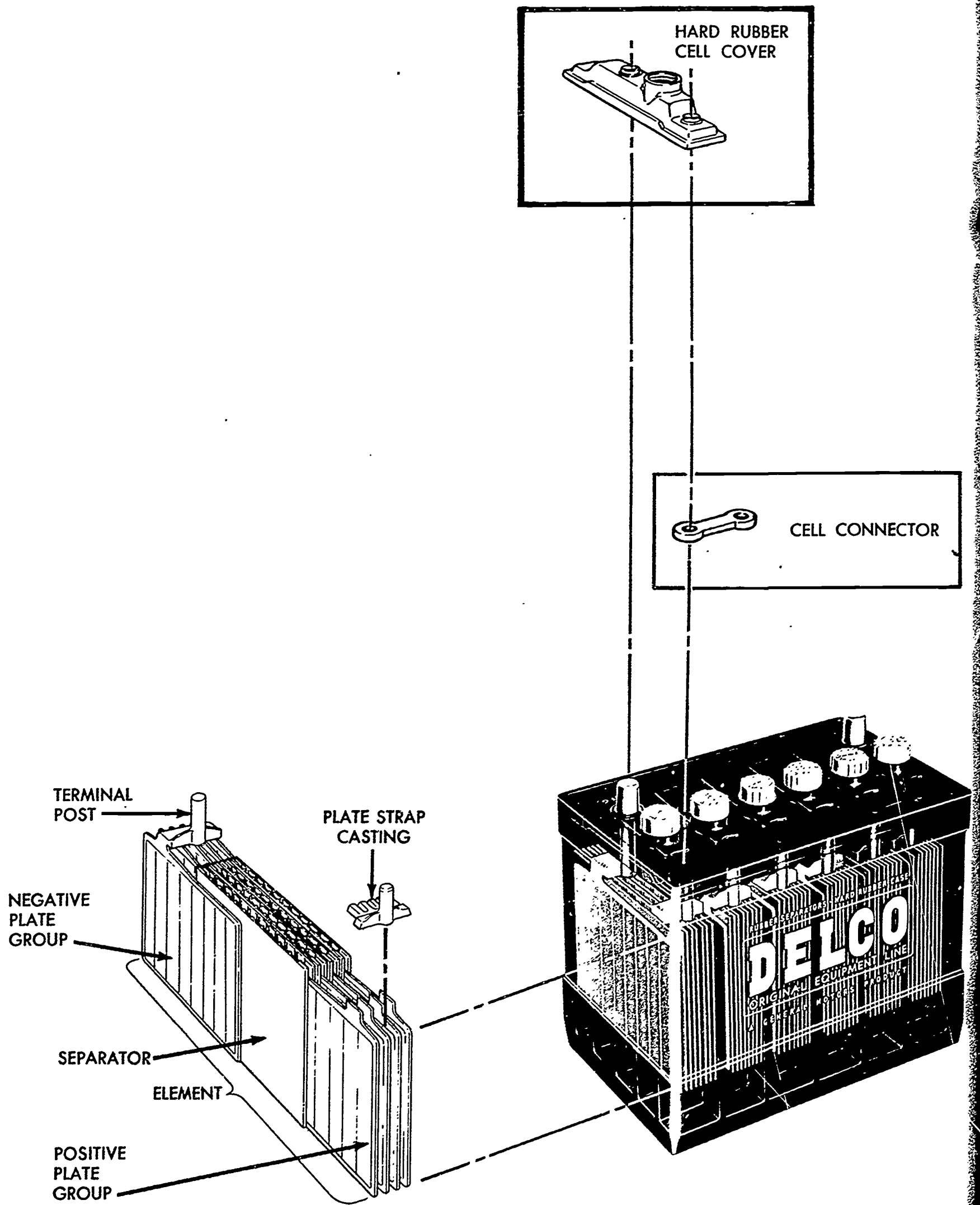

Fig. 2 Battery -- exploded view

After the element is assembled, it is placed in a CELL of the battery CASE. The case is made of a hard rubber compound with partitions separating the cells. In the bottom of the case are sediment chambers formed by bridges on which the elements rest. With the elements in place in the battery case, hard rubber CELL COVERS are fitted over the terminal posts of the elements. The cell covers come to rest upon mounting ledges inside each cell in the battery case. The cell covers on most batteries contain lead bushings molded into the hard rubber. These bushings slip freely over the terminal posts during assembly, but later are welded integrally with the posts at the surface of the cover to form an acid-tight seal.

After the covers are installed, CELL CONNECTORS are welded between the intermediate terminal posts of the adjoining cells to establish the series circuit. On batteries using lead bushing type cell covers, the main terminal posts are molded to the lead bushing and plate strap at the same time.

The final operation in battery assembly is the pouring of sealing compound into the junctions between the cell covers and the battery case. This material forms a close bond at the hard rubber surfaces and prevents leakage of electrolyte. See Figure 3.

A vent cap is located in each cell cover and serves two purposes. First, it closes the opening in the cell cover through which electrolyte can be

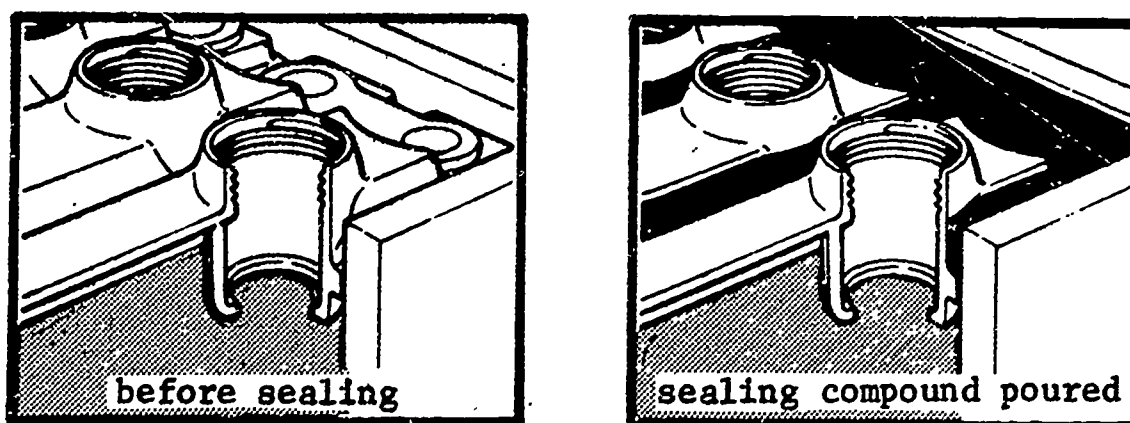

Fig. 3 Before and after sealing

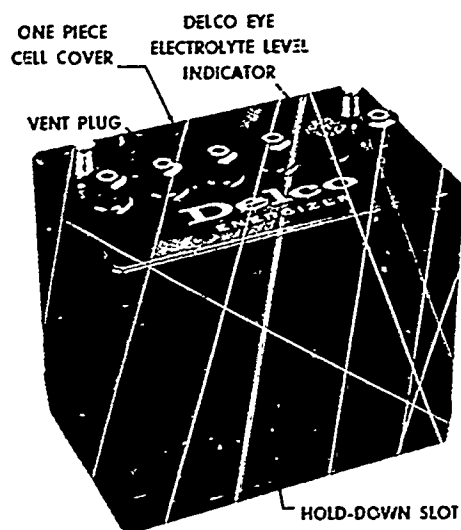

Fig. 4 Delco Energizer

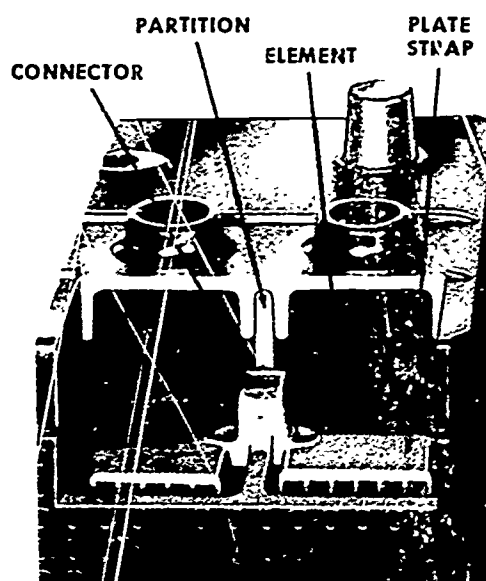

Fig. 5 Delco Energizer

checked and water added; and second, it provides a means for the escape of gases formed during charging. See Figure 4.

ENERGIZERS (battery with one piece hard rubber top) feature a one-piece cover which reduces the tendency for corrosion to form on the top of the battery. They also feature cell connectors that pass through sealed holes in the cell partitions to connect the elements together in the shortest distance that is practical. Reducing the length of the internal electrical circuit results in lower internal voltage drop and improved performance. See Figure 5.

SECTION B -- CHEMICAL ACTION IN BATTERIES

The chemical action of a battery is quite simple. A knowledge of its chemical behavior will help in understanding the battery and in diagnosing battery conditions.

In a battery, electrical energy is produced by chemical reaction between the active materials of the dissimilar plates and the sulfuric acid of the electrolyte. The availability and amount of electrical energy which can be

produced by the battery in this manner are limited by the active area and weight of the materials in the plates and by the quantity of sulfuric acid in the electrolyte.

After most of the available active materials have reacted, the battery can produce little or no additional energy. The battery then is said to be **DISCHARGED**. Before the battery can be further discharged, it must be recharged by being supplied with a flow of direct current from some external source. The charging current must flow through the battery in a direction **OPPOSITE** to the current flow from the battery during discharge. Therefore, the positive terminal of the charging unit should be connected to the positive terminal of the battery. This causes a reversal of the discharge reactions and the battery becomes recharged.

It should be noted that the material in the positive plates and negative plates becomes similar chemically during discharge, as the lead sulfate accumulates. This condition accounts for the loss of cell voltage, since voltage depends upon the difference between the two materials.

As discharge continues, dilution of the electrolyte and accumulation of lead sulfate in both plates eventually cause the reactions to stop. However, it should be noted that the active materials never are completely used up during a discharge. This occurs because the lead sulfate formed on the plates acts as a natural barrier to diffusion of electrolyte into the plates. When the cell can no longer produce the desired voltage, it is said to be discharged.

The chemical reactions which occur in the cell during charging are essentially the reverse of those occurring during discharge, as shown in Figure 6.

In normal operation, the battery gradually loses water from the cells, due to disassociation of the water into hydrogen and oxygen gases which escape to the atmosphere through the vent caps. If this water is not replaced, the level of the electrolyte falls below the top of the plates. This results in overconcentration of electrolyte and also allows the exposed active material to dry and harden. Thus, if the water level is not properly maintained, premature failure of the battery is certain to occur. Since water loss is more rapid during high temperature operation than at low temperatures, the electrolyte level should be checked more frequently during the summer months.

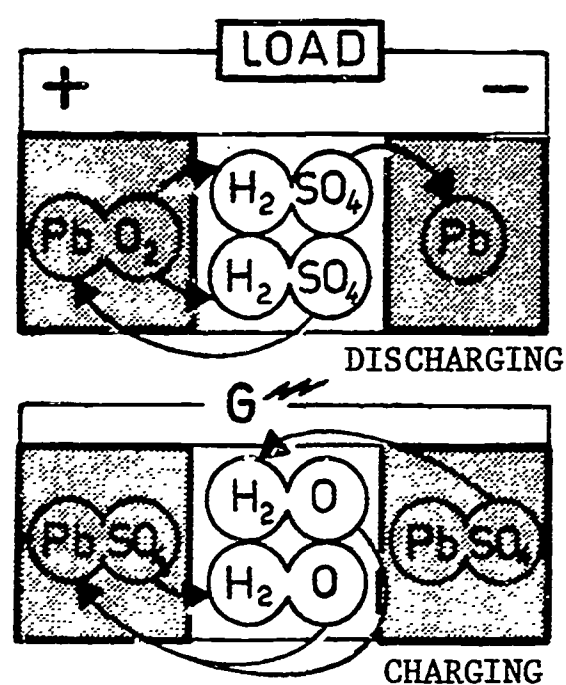

Figure 6

The purity of water for battery use is a controversial subject, but always resolves to the fact that distilled water is the best. Colorless and odorless drinking water is satisfactory; but when obtained from a faucet it should be allowed to run a few minutes before using.

SECTION C -- THE BATTERY AND THE CHARGING CIRCUIT

Battery electrical energy, produced by chemical action, is provided in the form of current flow to electrical accessories when they are connected to the battery. As the battery continues to supply current, all the available stored chemical energy is eventually used, and the battery becomes discharged. In order for the battery to supply additional current, the chemical energy must be restored to the battery.

It is the function of the generator to restore the chemical energy to the battery. This is accomplished by sending current through the battery in a direction opposite to that during discharge. The generator current

reverses the chemical action in the battery and restores it to a charged condition. While the battery is an electro-chemical device, it should be noted that the generator is electro-mechanical, converting mechanical power from the engine into electrical power.

In actual operation, the battery alone supplies the current to accessories when the generator is not running. Under certain speed and load conditions, the battery and generator both supply the load current. As generator speed increases, the generator supplies current to operate the accessories and to charge the battery. See Figure 7.

Since the generator voltage is directly proportional to speed, the voltage would become excessively high at high generator speeds. To limit the generator voltage to a safe value, a voltage regulator is included in the charging circuit. If the generator voltage were allowed to become exces-

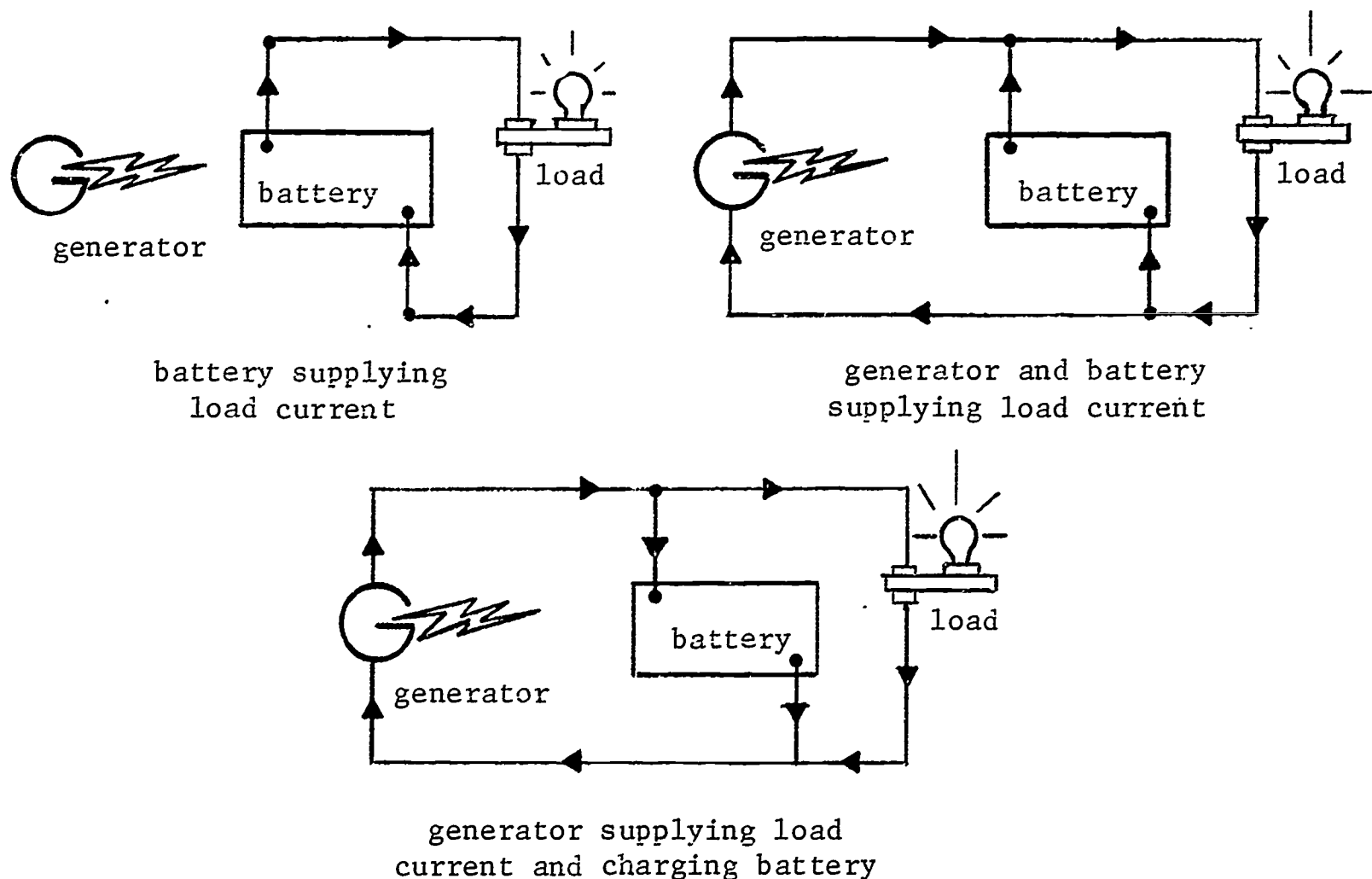
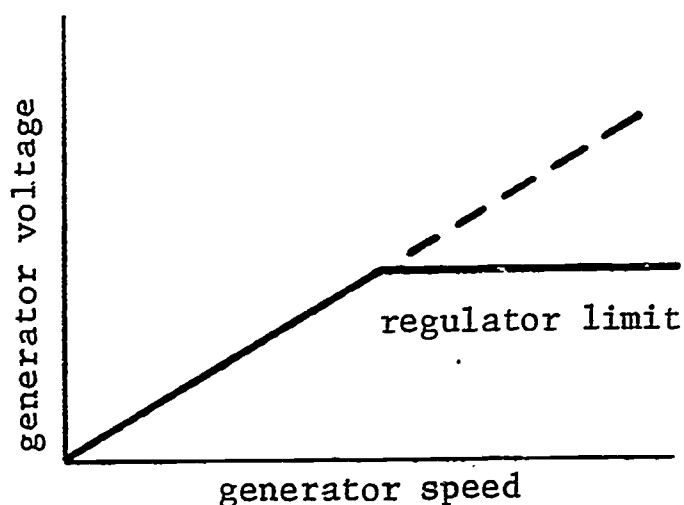

Fig. 7 The battery and the charging circuit

sively high, the generator would continue to supply high current to the battery after the battery became fully charged. This would result in over-charge and would damage the battery and possibly other accessories.

The chart illustrated in Figure 8 shows that generator voltage increases as generator speed increases, until it finally reaches the voltage regulator limit.



As the voltage regulator functions to protect the battery and accessories, it senses the battery voltage and limits the generator accordingly. The voltage

regulator, then senses -- and is affected by -- the battery voltage. This means the effectiveness of the voltage regulator is largely determined by how closely it is able to sense and follow the changing characteristics of the battery, such as battery voltage, state of charge, battery temperature, etc.

Fig. 8 Generator speed

SECTION D -- BATTERY CHARGING VOLTAGE

When the battery is being charged by the generator, the voltage measured across the battery posts is called the battery charging voltage. This voltage can be observed simply by connecting a voltmeter across the battery posts when the battery is being charged.

The battery charging voltage is made up of two factors. The formula expressing the relationship between these factors when the battery is being charged is: Battery Charging Voltage = $CEMF + IR_b$. An explanation and illustration of these factors follows, see Figure 9.

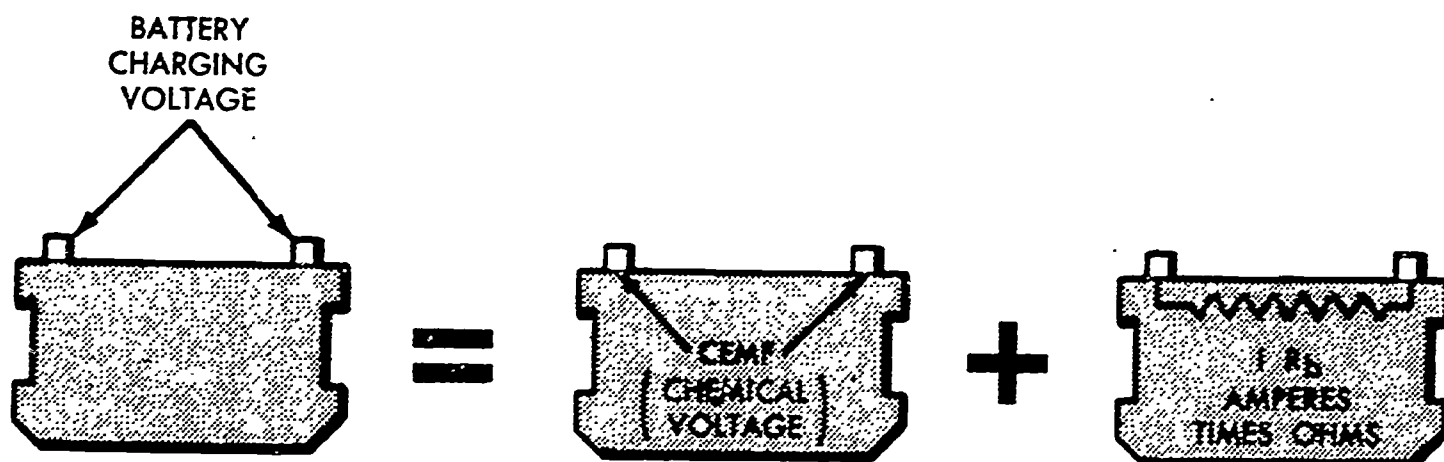

Fig. 9 Battery charging voltage

The CEMF is the battery counter-electromotive force, which is the voltage that is produced within the battery, mainly by chemical means. This CEMF opposes the battery charging voltage, and is the voltage which the battery charging voltage must overcome in order to charge the battery. The voltage produced by the generator, then, must always be higher than the CEMF when the battery is being charged.

The CEMF is affected by many factors, including charging rate, temperature, concentration of electrolyte, plate area in contact with the electrolyte, age of the battery, electrolyte impurities, gassing, and the state of charge.

Gassing causes the CEMF to increase because the gases (chiefly hydrogen at the negative plates) temporarily behave as active materials which yield a higher voltage. The state of charge has a very pronounced and important effect on CEMF, and this factor is covered in more detail later in the unit.

The other factor making up the battery charging voltage is the voltage drop (IR_b) caused by battery internal resistance. This factor is obtained by multiplying the charging rate in amperes (I) times the battery internal resistance in ohms (R_b). This is an expression of Ohm's law. The internal resistance consists of the normal resistance to current flow inherent in the battery posts, connector straps, welded connections, plate

area in contact with the electrolyte, electrical resistivity of the electrolyte, and other factors, including gassing and sulfated or discharged plates.

Gassing, consisting of hydrogen at the negative plates and oxygen at the positive plates, temporarily increases the battery resistance (R_b) because of the obstructive gas film that is formed on the surface of the plates. Sulfated plates -- plates with sulfate that has become hard, crystalline, and dense -- also causes the battery resistance (R_b) to increase.

One of the more important factors affecting the battery resistance (R_b) and consequently the voltage drop (IR_b) is temperature. This occurs because temperature has a very pronounced effect on the electrical resistance of the electrolyte. The effect of temperature on battery resistance is covered in considerable detail in a following section.

In summary, this section has explained the factors that make up what may be called the "voltage formula for a battery being charged". This formula states that the battery charging voltage, measured across the battery terminal posts, is equal to the sum of the battery counter-electromotive force (CEMF) and the battery voltage drop (IR_b). Thus, Battery Charging Voltage = CEMF + IR_b . This is a very important formula that is used to explain the behavior of the charging system when the battery state of charge and battery temperature vary. The next sections explain this behavior in more detail.

SECTION E -- EFFECTS OF STATE OF CHARGE ON BATTERY CHARGING VOLTAGE AND CHARGING RATES

In any charging system consisting of generator, regulator, battery and connecting wiring, the battery charging voltage and charging rate often are established by the state of charge of the battery. This section explains the effect that state of charge has on the battery charging voltage (as measured with a voltmeter connected across the battery posts) and on the charging rate to the battery (as measured by an ammeter connected in the charging circuit). As explained in the previous section, battery charging voltage equals $CEMF + IR_b$, where CEMF is the battery counter-electromotive force and IR_b is the voltage drop obtained by multiplying the charging rate in amperes (I) times the battery resistance in ohms (R_b).

The relationship between state of charge and CEMF is shown in Figure 10 for a battery on charge at a constant current. The curve shown is typical and illustrates the fact that as the state of charge increases, the CEMF increases. It follows then that state of charge will affect the battery charging voltage and the charge rate in amperes.

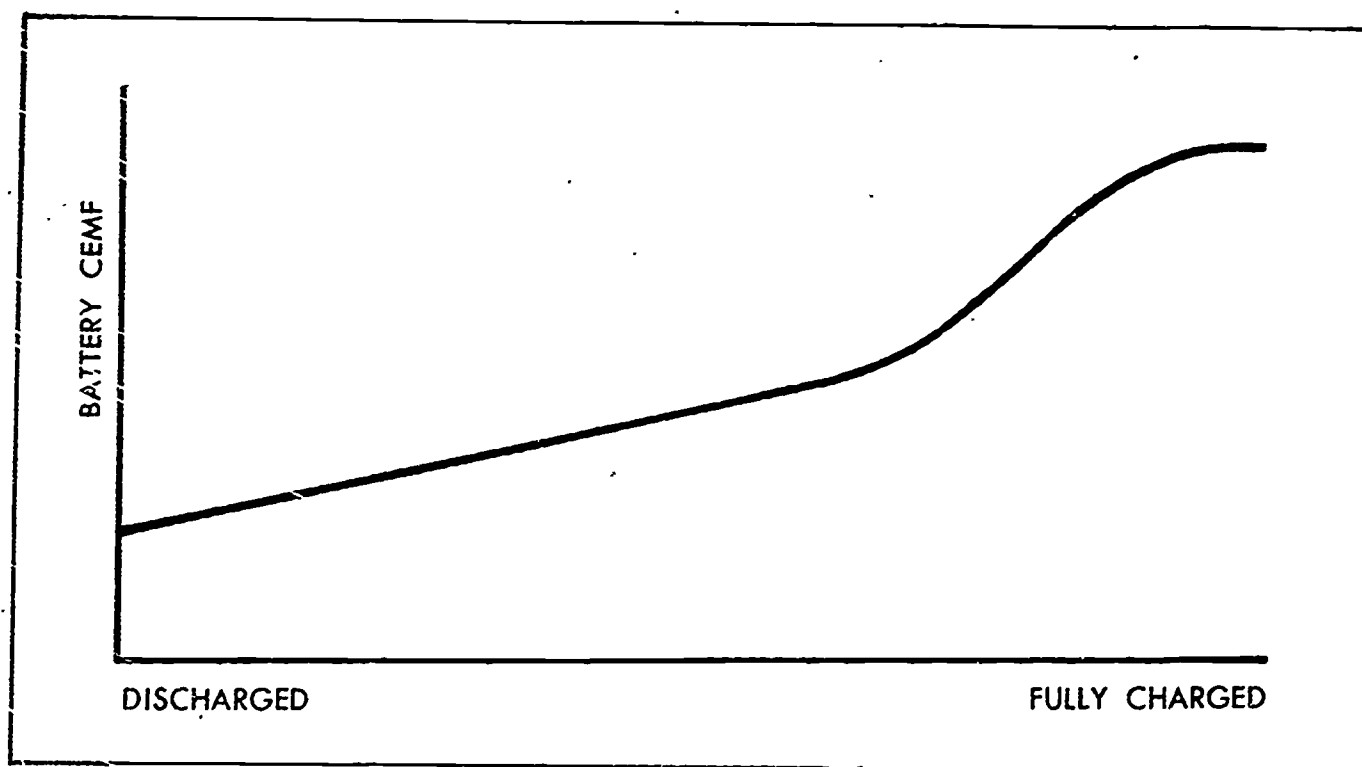

Figure 10

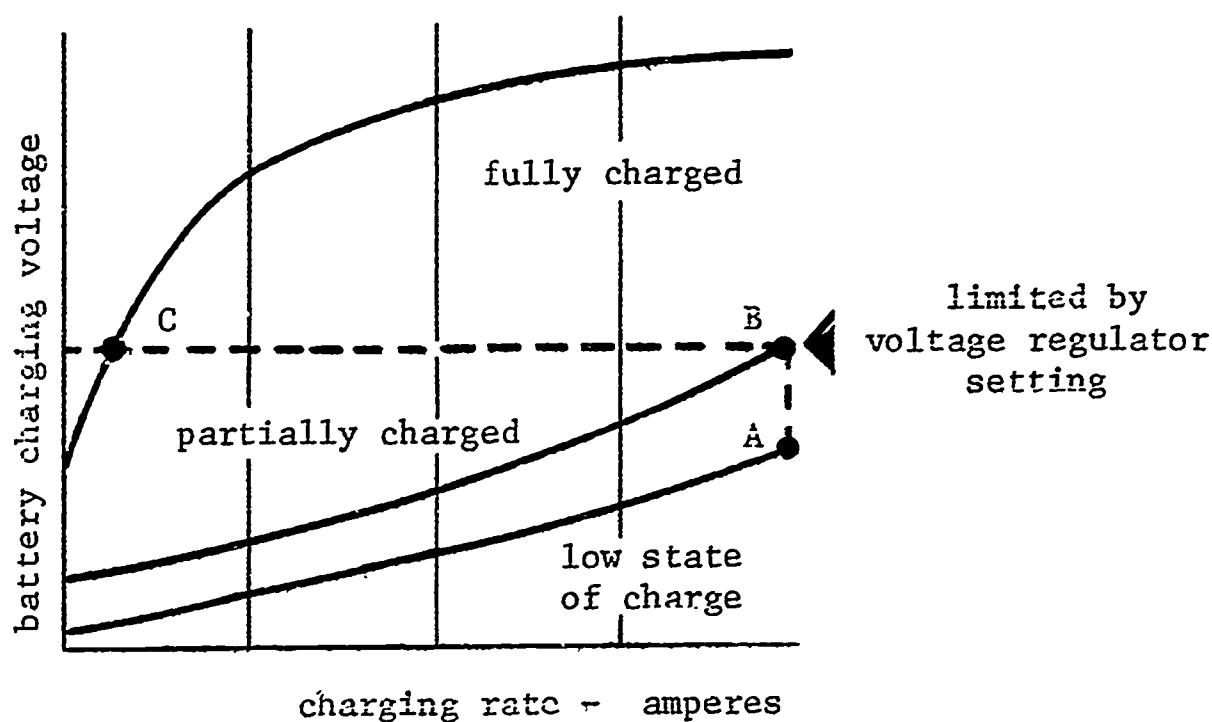

Fig. 11 Charging rate

Figure 11 illustrates the relationship between battery charging voltage at the battery terminals and charging rate (amperes) with a series of curves representing various states of charge for a typical passenger car type battery (at 80 F) as used in a typical charging system. The horizontal line, dividing the chart, represents a typical battery charging voltage, which is limited by the voltage regulator setting. The upper area indicates combinations of charging voltage and charging rates prevented by the voltage regulator setting. The lower area indicates normal operating combinations. The actual values on which these state of charge curves are based will vary with different types and sizes of batteries. These curves, however, may be considered as typical.

Consider first the curve for a battery that is in a low state of charge. Under this condition the battery CEMF is low, and with sufficient generator speed and output capacity, the charge rate to the battery will be high as shown by point (A) on the chart in Figure 11.

It is important to note that point (A) on the chart is below the voltage regulator setting. This means that the voltage regulator as illustrated is not operating (to limit the voltage) when the battery is in a low state of charge. A voltmeter connected across the battery posts would read some value below the voltage regulator setting under these conditions. Also, it is important to observe that at point (A) on the chart, the charge rate to the battery is high. This is ideal, since it is desired that the battery in a low state of charge be recharged as soon as possible.

As the generator continues to charge the battery at a constant rate, as indicated by the vertical line (A-B) on the chart (this occurs when the generator is current limited), the battery state of charge increases, and the battery CEMF increases. The (IR_b) drop remains essentially constant, as the charge rate (I) is constant. This means that the battery charging voltage will increase as the charging continues, until the battery charging voltage reaches the value that causes the voltage regulator to operate, as shown at point (B) on the chart.

To summarize the operating conditions between points (A) and (B) (low state of charge to partially charged):

1. The battery charging voltage is below the voltage regulator setting.
2. The voltage regulator is not operating.
3. The battery CEMF is increasing.
4. The charging rate (I) is constant.
5. The battery charging voltage is increasing.

Another method of summarizing the operating conditions between points (A) and (B) as the state of charge increases from a low state of charge to a higher (but not full) state of charge is to refer to the familiar charging formula:

$$\text{Battery Charging Voltage (increasing)} = \text{CEMF (increasing)} + IR_b \text{ (constant)}$$

At point (B), the battery charging voltage has risen to the point where the voltage regulator starts to operate to limit the charging voltage. With the charging voltage limited by the regulator to the value shown between the two areas on the chart, the battery charging voltage remains constant as the charging continues. As the state of charge progresses from partially charged to fully charged -- point (B) to point (C) -- the battery CEMF increases. This means that the (IR_b) drop must decrease. A decrease in (IR_b) is realized as the charge rate (I) decreases or tapers off from the high value shown at point (B) to the low value shown at point (C).

To summarize the operating conditions between points (B) and (C) (partially charged to fully charged):

1. The voltage regulator is operating.
2. The battery charging voltage is constant.
3. The battery CEMF is increasing.
4. The charging rate in amperes is decreasing.

Another method of summarizing the operation between points (B) and (C) is to refer to the battery charging formula:

$$\text{Battery Charging Voltage (constant)} = \text{CEMF (increasing)} \\ + IR_b \text{ (decreasing)}$$

The curve in the upper half of Figure 11 shows the charging rate which would occur if the voltage regulator did not operate to reduce or limit the charging process.

The effect that state of charge has on the charging system is to some extent ideal because it enables the battery to "take care of itself". For example, when in a low state of charge, it is desired that the battery be recharged as quickly as possible, and this is what happens, because the battery will accept a high rate of charge under these conditions. As the battery approaches full charge, it is desired that the charge rate taper off to lower values, to protect the battery from overcharge and overheating. Here again, this is what happens, as shown by the decreasing charge rate between points (B) and (C).

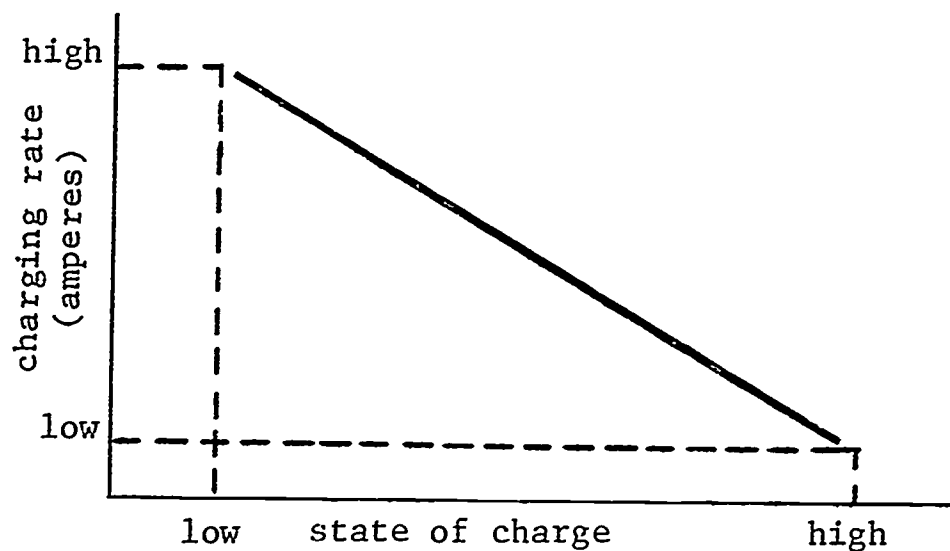

Fig. 12 State of charge

We can now see that the voltage regulator setting must match the charge requirements of the battery. Without any voltage limitations at all, charging rates, of course, would be indicated by the fully charged curve in the upper area of the chart.

In conclusion, when the state of charge is low, the CEMF is low and the battery will accept a high rate of charge. When the state of charge is high, the CEMF is high and the charge rate is low. The state of charge, through its effect on the battery CEMF, often establishes the charging voltage and the charging rate in a typical charging circuit. See illustration in Figure 12.

SECTION F -- EFFECTS OF TEMPERATURE ON BATTERY CHARGING VOLTAGE AND CHARGING RATES

Battery temperature has a very pronounced effect on charging circuit behavior primarily because of the temperature effect on the resistance, or resistivity, of the electrolyte. The relationship between temperature and the battery resistance (R_b) is shown in the chart in Figure 13. This typical curve shows simply that: as the temperature decreases, the resistance increases. This suggests that a cold battery having high resistance will be hard to charge, and a hot battery will be easy to charge.

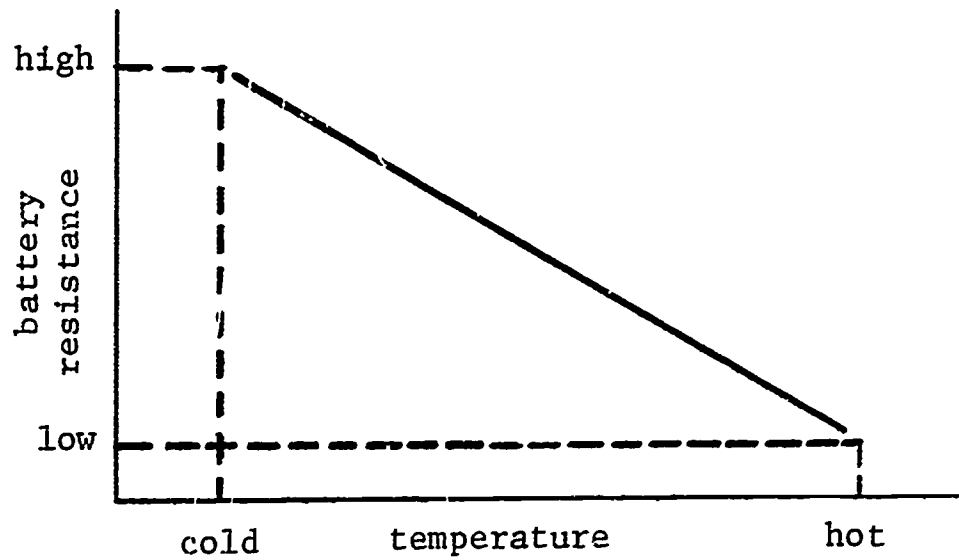

Fig. 13 Temperature

Figure 14 shows battery charging voltages and charging rates for both fully charged and partially charged batteries that are hot and cold. These typical curves are based on the assumption that there is sufficient output to provide the voltage and currents indicated.

For a fully charged battery, the charging rate should be reasonably low at all times in order to protect the battery from overcharge and overheating. As shown by the curves in Figure 14, the low charging rate at the setting of the voltage regulator does indeed occur when the battery is cold. However, the charging rate is much higher when the battery is hot. This occurs

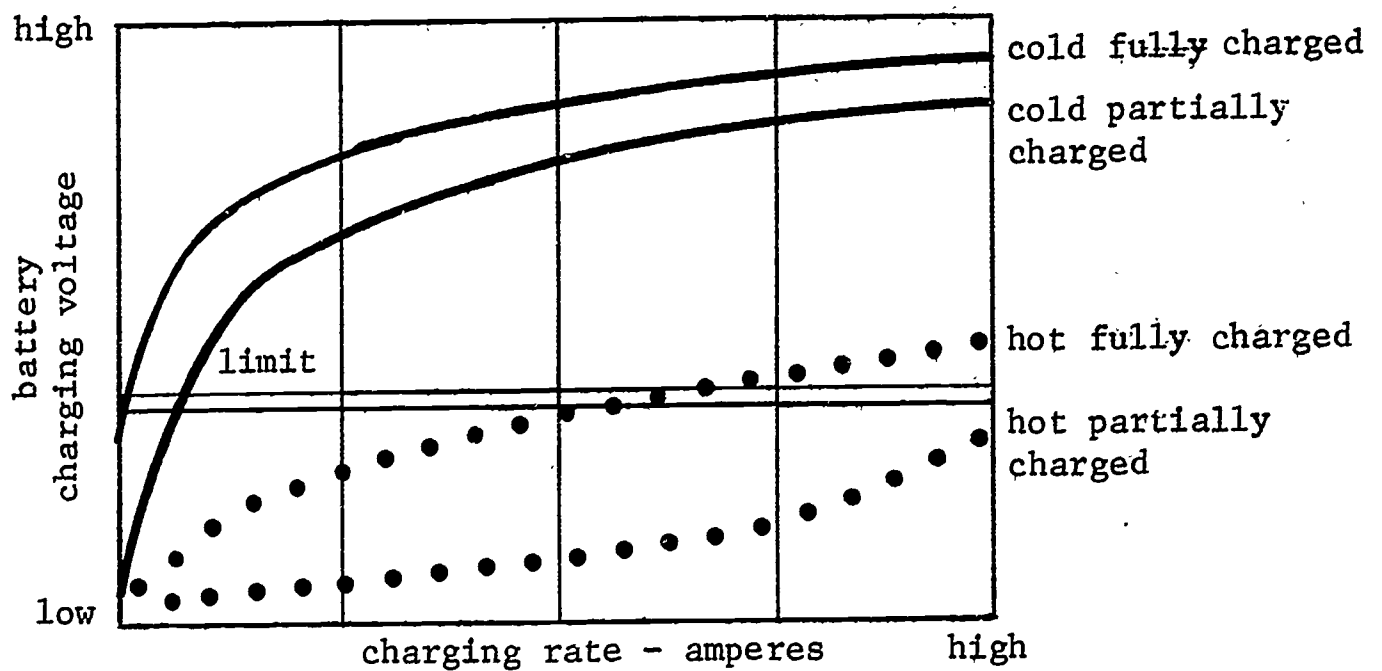

Fig. 14 Charging rate

because the electrolyte resistivity and battery resistance decrease, allowing an increase in the charging current (I). This is true, since Battery Charging Voltage = $CEMF + IR_b$. This high charge rate generally is undesirable, because the battery already is fully charged. However, no harm will be done as long as the charging rate is limited to short periods of time. If the system operation is such as to subject the battery to long charging periods at the high temperature, the voltage regulator setting would need to be lowered to reduce the charging rate.

Next, consider the charging rate curves for a typical battery that is partially charged. The effect of a hot temperature is to allow a high charge rate to the battery. This is not objectionable, because it is desired that the battery be recharged in a minimum length of time. Under these conditions, the electrolyte resistivity is low; and consequently the battery resistance is low, allowing the high charge rate.

When the partially charged battery is cold, the electrolyte resistivity is high, and the battery resistance is high. The charge rate then is much less than at higher temperatures. If the operating conditions are such as to subject the partially charged battery to a reasonably long charging period, the battery will become fully charged. However, if the charging periods are not sufficient in length, it may be necessary to raise the voltage regulator setting in order to bring the battery up to full charge.

Some charging systems that are subject to considerable extremes in temperature use regulators whose voltage setting changes with changes in temperature. The regulator automatically operates to provide a higher voltage setting during cold climatic conditions, and a lower setting during hot weather. This temperature compensation tends to protect the battery from undercharge in cold weather and from overcharge in hot weather. See Figure 15.

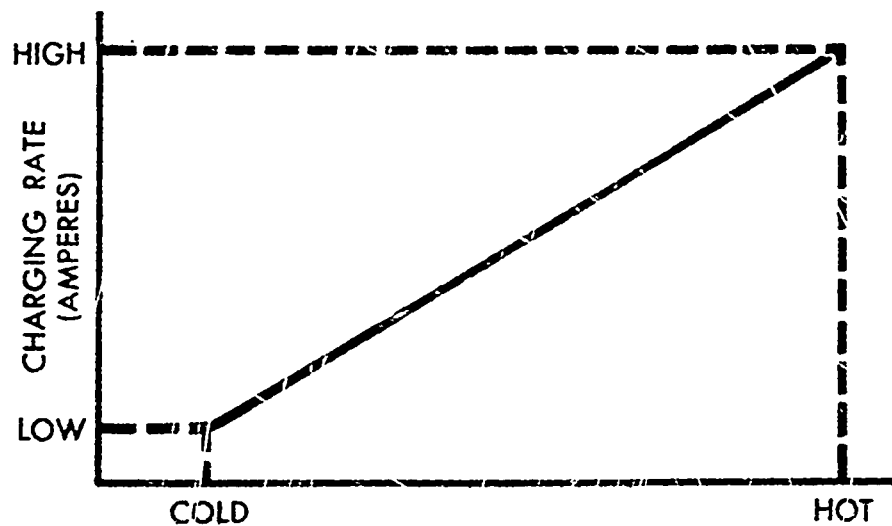

Fig. 15 Temperature

Other charging systems, due to inherent operating characteristics of the generator and battery, do not require a regulator with temperature compensation. These regulators provide a voltage that is unaffected by changes in temperature.

It may be necessary in some charging systems to tailor the voltage regulator setting if climatic conditions are severe. Raising the voltage regulator setting to a higher value, if the operating environment is consistently very cold, may be necessary in order to maintain the battery in a fully charged condition. Conversely, lowering the voltage regulator setting may be necessary in consistently hot climates to prevent battery overcharge and excessive loss of water.

The need for tailoring the voltage setting is, however, usually limited to cases involving extremes in operating periods and operating temperatures. Charging systems are designed so that the battery will be maintained in a satisfactory state of charge when subjected to normal operating periods and to normal summer and winter temperatures, with no need for changing the voltage setting.

SECTION G -- TERMINOLOGY

The meanings of words often are misleading when used in varying situations. An attempt has been made in the following list to simplify words that are commonly used when dealing with automotive storage batteries.

- ACTIVE MATERIAL** -- The material of which the plates are made. Peroxide of lead (brown in color) and sponge or metallic lead (gray in color) -- positive and negative plates, respectively -- upon which the sulfuric acid acts.
- AMPERE (AMP)** -- The unit of measurement to determine the flow of electrons in a circuit. Measures current flow.
- AMPERE-HOUR** -- The unit of measurement for determining battery capacity, obtained by multiplying the current flow (in amperes) by the time (in hours) that the current flows.
- AMMETER** -- An instrument for measuring electron flow in amperes.
- ANODE** -- Equivalent to the positive terminal of a battery.
- BATTERY** -- A group of two or more cells connected together to produce an electric current. It converts chemical energy into electrical energy. With reference to an automobile, any number of complete electrical cells assembled in one housing or battery case.
- CATHODE** -- Equivalent to the negative pole or electrode of a battery.
- CELL** -- In a flashlight "battery," a dry cell; in a storage battery, a compartment for containing positive and negative plates which, with electrolyte, generates electricity.
- CHARGE (RECHARGE)** -- To restore the active materials in a battery by passing a direct current through it in a direction opposite to that of discharge.
- CIRCUIT** -- The complete path provided for current flow. This complete path is called a closed circuit; and when its continuity is broken, an open circuit.
- CIRCUIT (SERIES)** -- A circuit which provides only one path for the current to flow. In a storage battery, the connection of negative-to-positive and positive-to-negative.

- CIRCUIT (PARALLEL)** -- A circuit which provides more than one path for current to flow. An arrangement whereby all positive poles, terminals, etc., are connected to a conductor and all negative poles, terminals, etc., are connected to another conductor. This arrangement provides full electrical potential (voltage) to all portions of the circuit.
- CONDUCTOR** -- A wire or other metallic object capable of transmitting electricity.
- CONNECTOR** -- A device used to link components of an electrical circuit together.
- CURRENT** -- The movement of electricity, comparable to the flow of a stream of water. Sometimes used to identify the rate of such movement. The movement of free electrons along a conductor.
- CURRENT (ALTERNATING)** -- A periodic conduction current that reverses its direction at regular intervals.
- CURRENT (DIRECT)** -- An electrical current flowing in one direction only.
- COUNTER-ELECTROMOTIVE FORCE (CEMF)** -- The total of two opposing voltages within the battery to a charging current; the internal resistance (voltage drop) and the chemical voltage.
- CYCLE** -- A series of events that occur over and over in a given sequence. In a battery, the process of constant discharging and charging.
- DRAW (AMPERAGE)** -- The quantity of current used to operate an electrical device.
- DROP (VOLTAGE)** -- The net difference in electrical pressure when measured across a resistance.
- ELECTRICITY** -- The movement of electrons from one body of matter to another.
- ELECTRODE** -- Either terminal of an electric source; especially either conductor by which the current enters and leaves an electrolyte.
- ELECTROLYTE** -- A substance in which the conduction of electricity is accompanied by chemical decomposition. In a battery, a mixture of sulfuric acid and water.
- ELECTROMOTIVE FORCE** -- That which moves or tends to move electricity. Caused by a difference in electrical potential. Voltage.

ELEMENT-- In a battery, one set of positive and negative plates complete with separators in assembled form.

ELECTRON -- The negatively charged particles of an atom which revolve around the nucleus.

ELECTRON THEORY -- States that all matter is made up of atoms which contain electrons, some of which are free to move from one atom to another.

ENERGY -- The capacity for doing work--with a source of either chemical reaction, electrical action, or mechanical action.

FREE ELECTRON -- An electron in the outer orbit of an atom, not strongly attracted to the nucleus; it can easily be forced out of its orbit.

GRID -- A lead-antimony framework which supports the active material of a battery plate and conducts current.

GROUND -- The connection made in grounding a circuit. In automotive use, the result of attaching one battery cable to the body or frame, which is used as a path for completing a circuit in lieu of a direct wire from a component.

HYDROMETER -- A float type instrument for determining specific gravities, such as the density of battery electrolyte.

IONIZATION -- When a molecule of gas loses electrons due to electrical excitation. To render or become conducting, supposedly by the formation of ions.

JAR -- In a battery, the rubber or composition container for a cell.

LEAD-ACID BATTERY -- A common battery in which the secondary cells are composed of lead, lead peroxide, and a solution of sulfuric acid.

LIVE -- Electrical parts attached to the insulated part of an electrical system: often called the "hot lead."

NEGATIVE -- Designating or pertaining to a kind of electrical potential. The negative plate of an electrolytic cell--the point from which electrons flow.

OHM -- The practical unit for measuring electrical resistance.

OHMMETER -- A test device used to measure electrical resistance.

POLARITY -- The quality or condition in a body which has opposite properties or directions; having poles, as in an electric cell, a magnet, or a magnetic field.

POSITIVE -- Designating or pertaining to a kind of electrical potential--tending to lose electrons and thus become positive; opposite of negative.

POTENTIAL -- A latent or unreleased electrical energy.

PRIMARY -- An electric cell which cannot be recharged, e. g., a flashlight "battery". Also in a transformer, the winding which is attached to the source of current.

RESISTANCE -- The opposition offered by a substance or body to the free flow of an electric current.

RHEOSTAT -- A resistor for regulating a current by means of a variable resistance.

SECONDARY CELL -- One of the cells in a battery. It can be recharged by passing a current through it in a direction opposite to that of discharge.

SHORT CIRCUIT -- Often used to describe an intentional grounding of a circuit. More accurately, a path created when an insulation breakdown occurs.

SPECIFIC GRAVITY -- The ratio of the weight of any volume of a substance to the weight of an equal volume of some substance taken as a standard; usually water for solids and liquids and air or hydrogen for gases.

TERMINAL -- A device attached to the end of a wire or cable or to an apparatus for convenience in making electrical connections.

VOLT -- A practical unit for measuring current pressure in a circuit; that force which, when steadily applied to a conductor with a resistance of one ohm will produce a current flow of one ampere.

VOLTMETER -- An instrument for measuring the differences of potential between different points of an electrical circuit.

WATT -- The unit for measuring electrical energy or work. One watt is the product of one ampere multiplied by one volt.

WATT-HOUR -- The unit of electrical energy obtained by multiplying the ampere-hour output by the average voltage during discharge.
(Watt-hours equal volts x amperes x hours.)

BATTERY CONSTRUCTION DETAILS

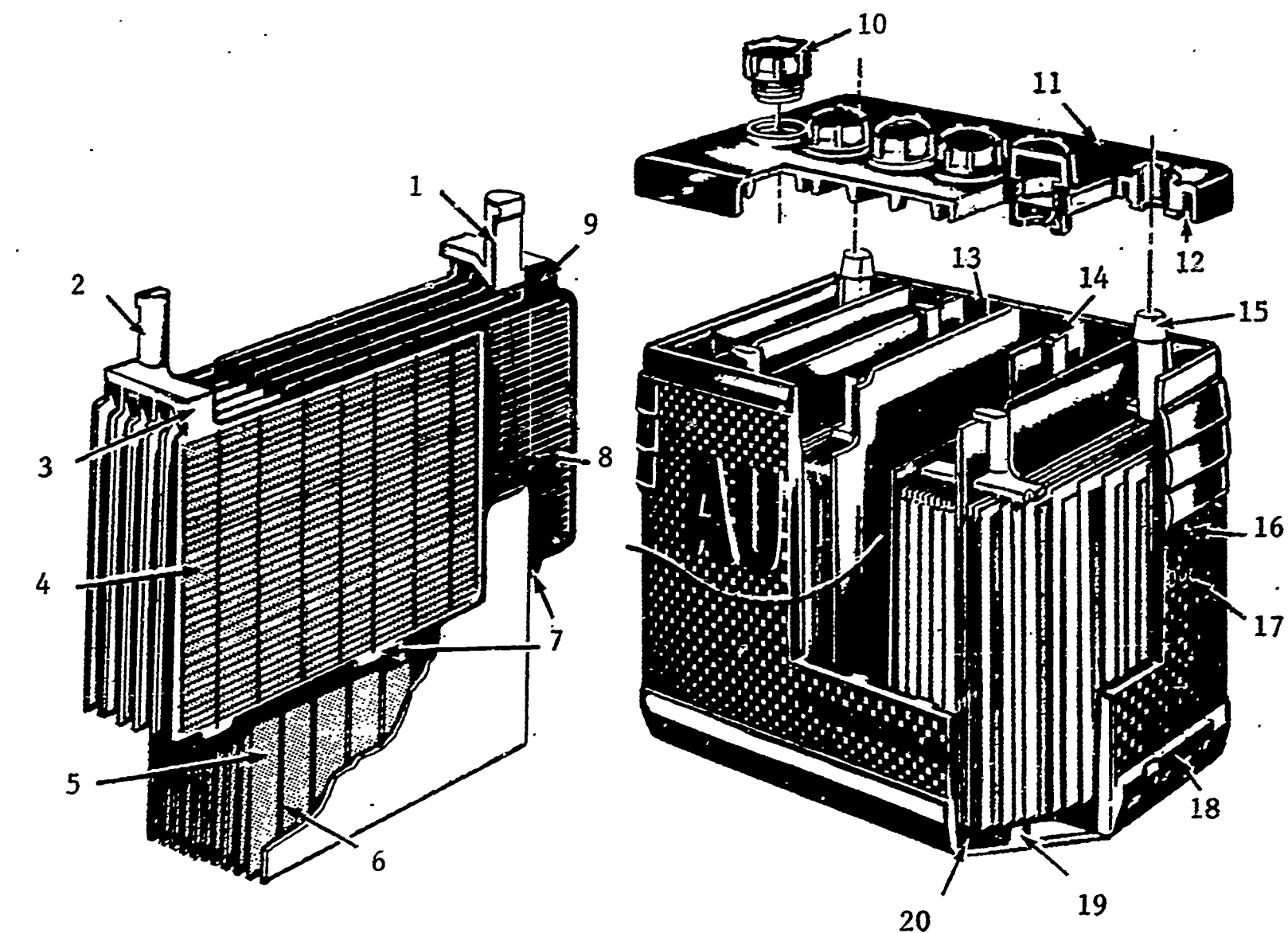

- | | |
|--|------------------------------|
| 1. Positive cell terminal and strap | 11. One-piece cover |
| 2. Negative cell terminal and strap | 12. Epoxy resin sealing lip |
| 3. Negative terminal lug | 13. Cell partition |
| 4. Negative plate (grid and sponge lead) | 14. Over-partition connector |
| 5. Separator | 15. Terminal post |
| 6. Separator rib | 16. Container |
| 7. Plate feet | 17. Ampere-hour rating |
| 8. Positive plate (grid and lead oxide) | 18. Mounting ledge |
| 9. Positive terminal lug | 19. Element rest |
| 10. Vent plug | 20. Sediment space |

Fig. 16 Battery construction details

DIDACTOR PLATES FOR AM 2-12D

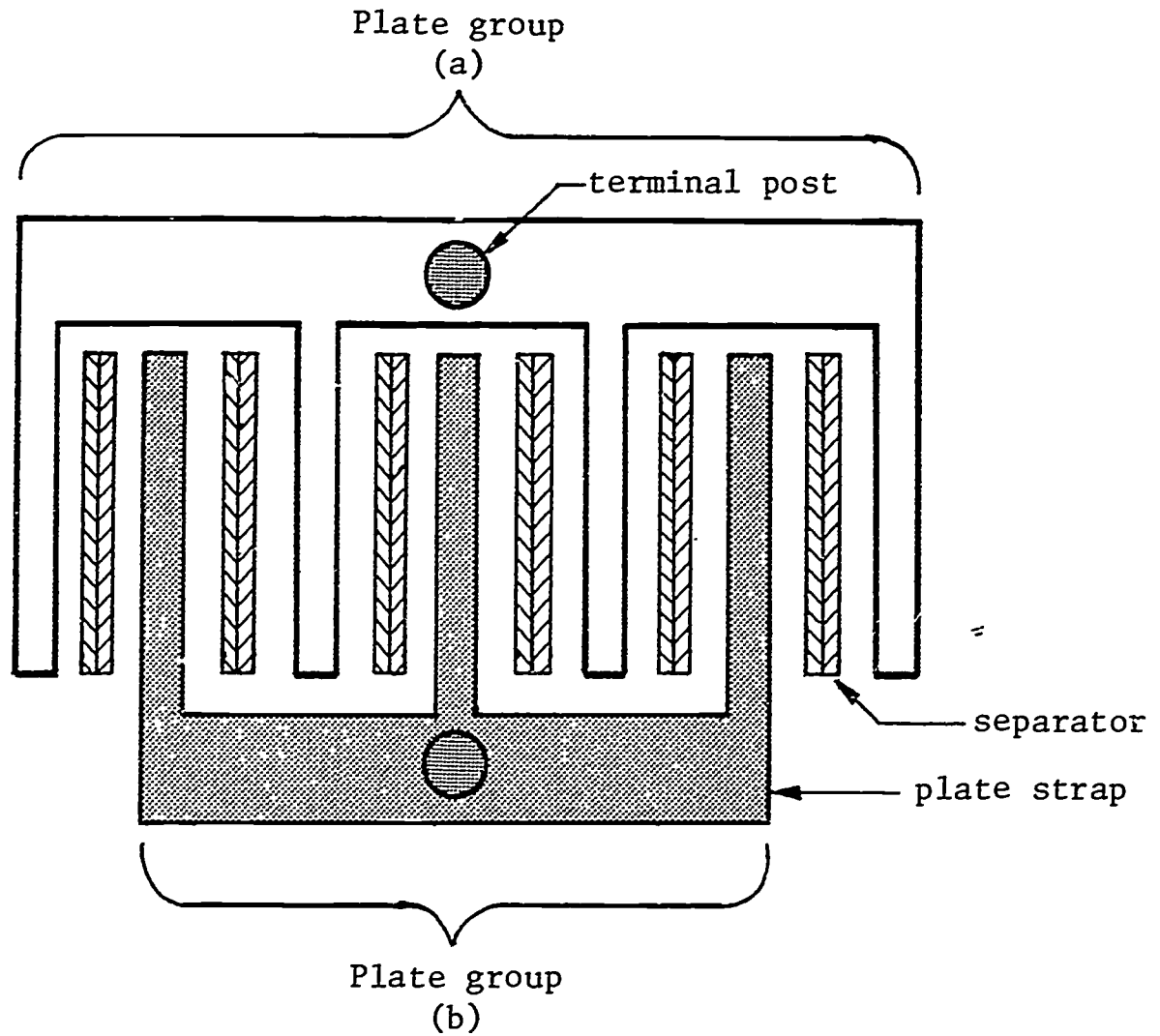

Plate I Battery element or "cell pack"

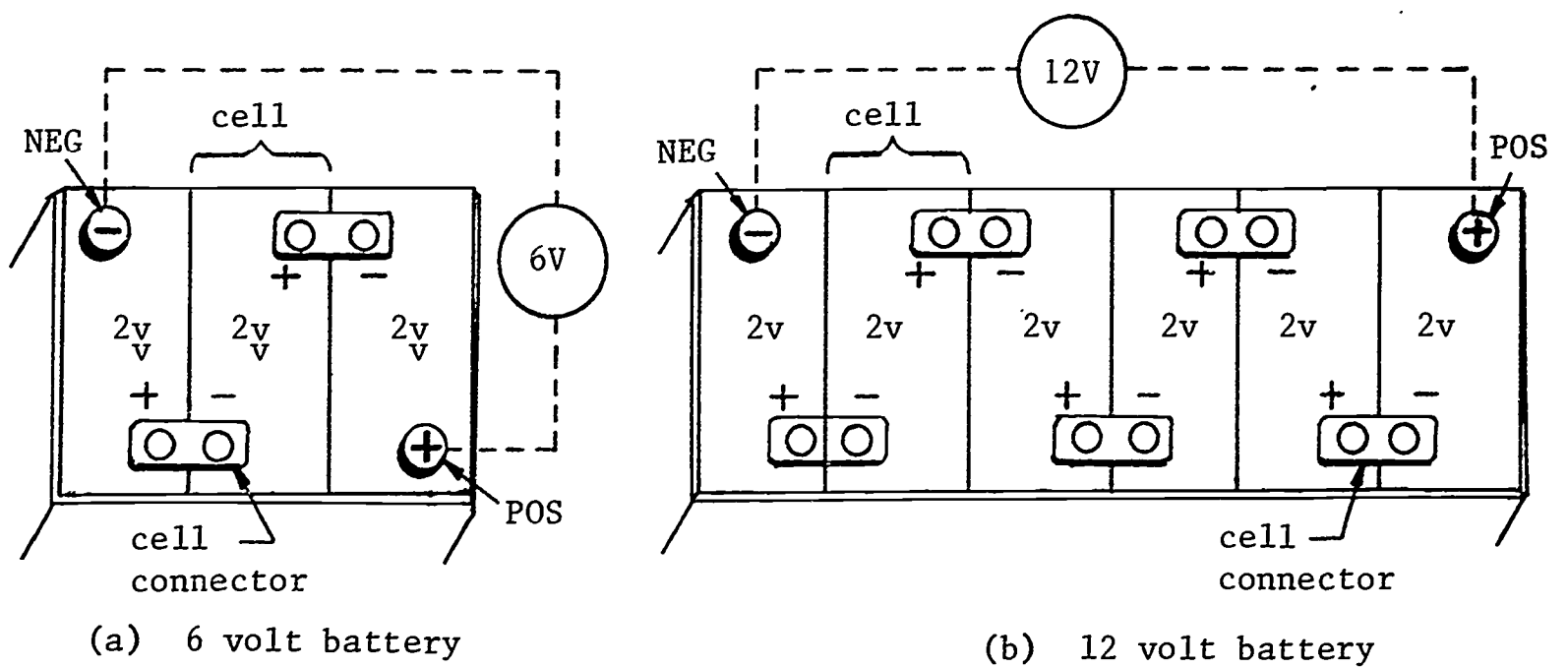
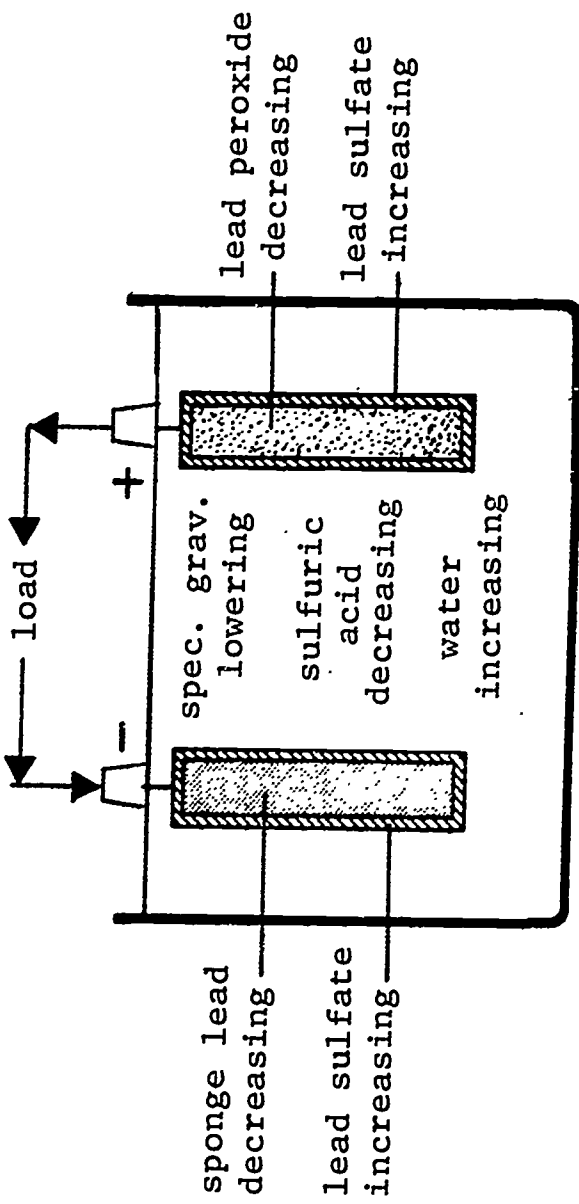
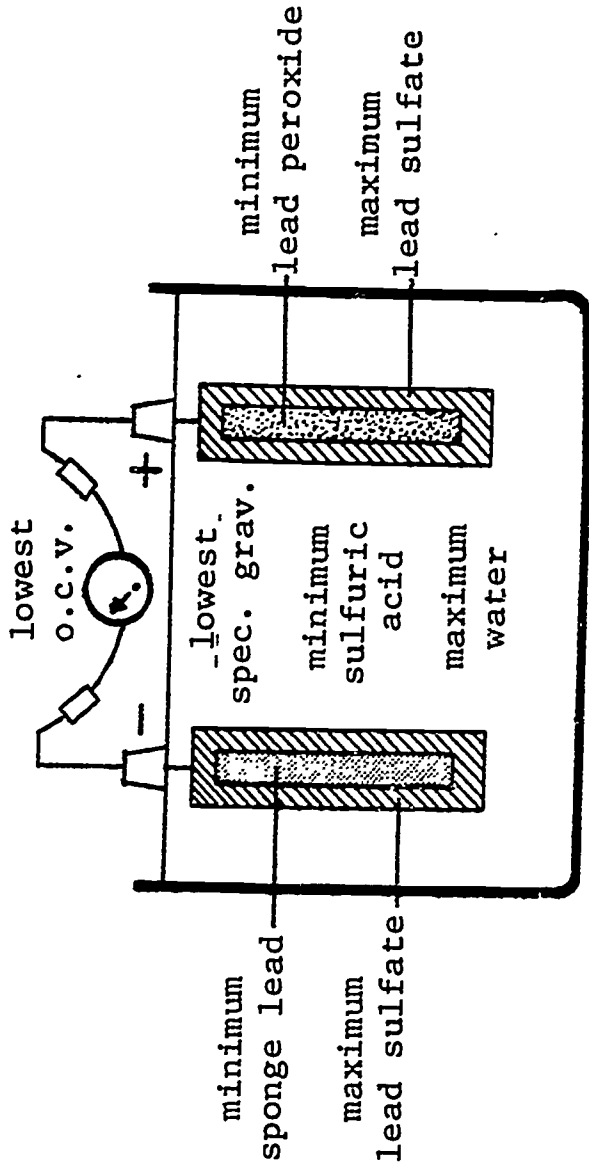

Plate II Cell connections (series circuit) in 6 volt and 12 volt batteries



(a) Discharging



(b) Fully discharged

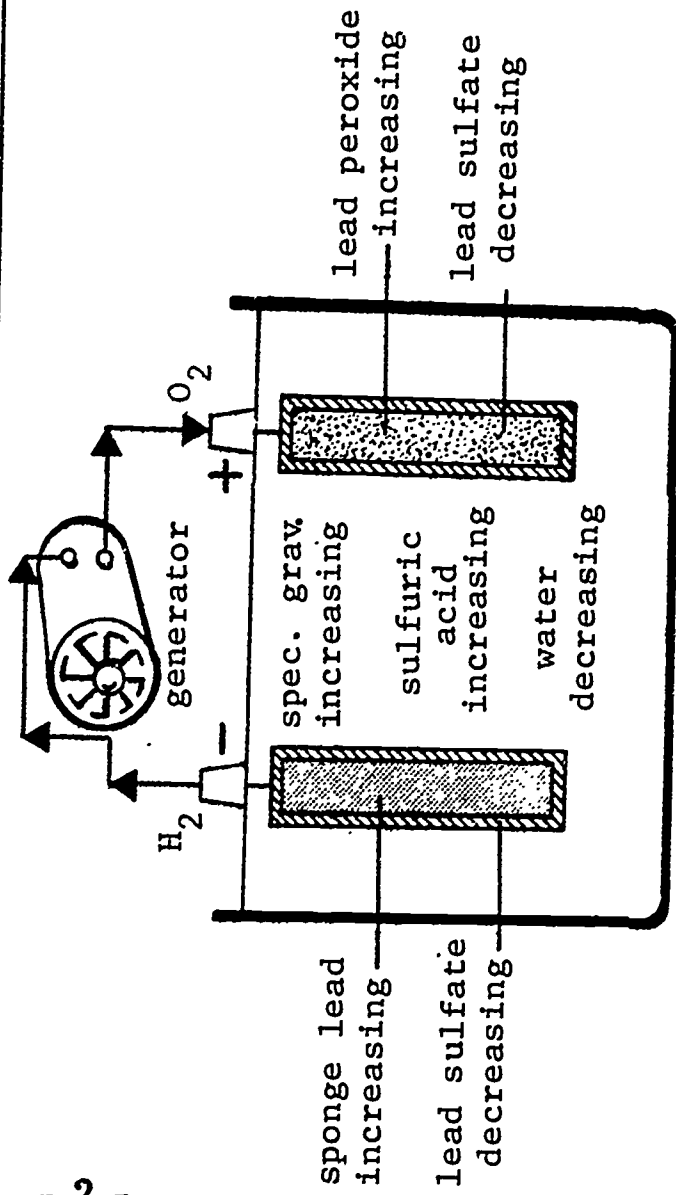

(c) Charging

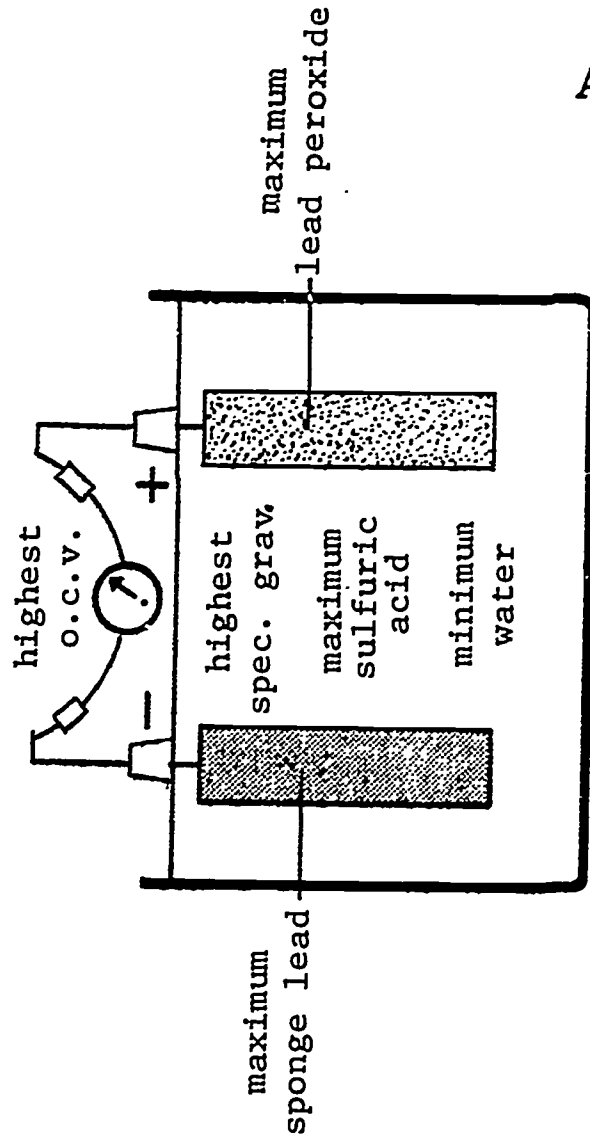

(d) Fully charged

Plate III Chemical action in lead-acid storage battery

AM 2-12D
10/4/67

**AUTOMOTIVE BATTERIES I --
INTRODUCTION TO THE LEAD-ACID STORAGE BATTERY**

Human Engineering Institute Minn. State Dept. of Ed.
Vocational Education

Press A 1 Check to see that timer and index
are OFF.

In this film we will talk about the construction,
operation and functions of the lead-acid storage
battery.

We will see how automotive batteries are made,
how they react under normal operating conditions,
and how they react under varying conditions of
charge and temperature.

Press A 2 1-1

A lead-acid storage battery is an **ELECTRO-
CHEMICAL** device designed to convert **CHEMICAL**
energy into **ELECTRICAL** energy.

A battery is not a "storage tank for electricity,"
but rather a device which stores electrical energy
in chemical form.

Press A 3 1-2

As a battery "discharges," it converts (1) _____
energy into (2) _____ energy.

- A. (1) electrical (2) chemical 4
- B. (1) chemical (2) electrical 6
- C. (1) mechanical (2) electrical 5

1-3

You have the correct answers reversed.

You said that a battery converts electrical energy
into chemical energy.

We asked for what happens during **DIS**charge.
As the battery discharges, it converts **CHEMICAL**
energy into **ELECTRICAL** energy.

Press A 6 1-4

Not quite. You said "mechanical to electrical."

Perhaps you were thinking of another part of the
automotive electrical system. The generator,
for example, converts mechanical energy into
electrical energy by electromagnetic induction.

The battery, on the other hand, converts
CHEMICAL energy into **ELECTRICAL** energy.

Press A 6 1-5

OK.

In automotive use the battery serves one or
more of three basic functions.

FIRST:

It supplies electrical energy to the **CRANKING
MOTOR** (and to the **IGNITION SYSTEM** of
electrically-started gasoline engines).

Press A 7 1-6

SECOND:

The battery supplies energy to the lights, heater,
radio and other such accessories when the
electrical demand of these devices exceeds the
output of the generator or alternator.

Press A 8 1-7

8

In an operating engine, if the electrical accessory load is presently at 20 amps and the generator is supplying 35 amps, then the battery will have to supply _____ ampe of current.

A. 15 **9**
 B. zero **11**
 C. I'm not sure **10**

1-8

9

You are incorrect.

We said that the battery supplies current to the electrical accessories when their demand exceeds the output of the generator or alternator.

In the situation given, the generator output (35 amps) exceeds the load demand (20 amps) of the accessories.

Press A **11** 1-9

10

No.

You will recall that the battery supplies current to the accessories when their demand for current (the load) exceeds the generator output.

In the situation given, the generator output is 35 amps, while the load is only 20 amps.

Think carefully and try the question again. Press A **8**

1-10

11

OK. The load demand does not exceed the generator output; so the battery will not have to supply current to the accessories. (The extra 15 amps output would be available for battery charging.)

The third basic function of the battery is to stabilize the voltage in the electrical system.

Unless the battery performs each of the functions it is designed to perform, the vehicle will not operate in a satisfactory manner.

Press A **13** **X(c)-12** 2-11

12

OK. The battery will not have to supply current to the accessories in the situation given.

Let's have a brief review of the material we have covered so far, since you had trouble with at least one question.

When you answer both questions correctly, we'll look at the construction of the lead-acid storage battery.

Press A **2** 1-12

13

A lead-acid storage battery is designed to provide a highly reliable source of electrical energy.

The basic unit of internal construction in this type of battery is the PLATE. Plates are made up of chemically active materials contained in flat, rectangular castings called GRIDS.

Press A **14** 2-13

14

A grid (cast of a lead and antimony alloy) has heavy borders which surround a lattice-like mesh of horizontal and vertical wires. Chemical pastes are spread over and through this mesh to form the plates.

When the plates are processed and cured, the materials become chemically active and the plates are said to be CHARGED.

Press A **15** 2-14

15

In order for the battery to work, two types of plates are needed -- positive plates and negative plates.

A charged POSITIVE PLATE contains lead peroxide (PbO₂) which is dark CHOCOLATE-BROWN in color.

A charged NEGATIVE PLATE contains sponge lead (Pb) which is GRAY in color.

Press A **16** 2-15

16

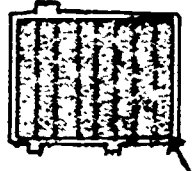

(a) sponge lead Pb
(gray)

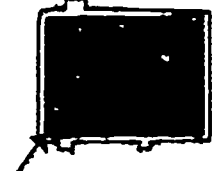

(b) PbO₂ lead peroxide
(chocolate brown)

Sketch (a) is a (1) plate; sketch (b) is a (2) plate.

A. (1) negative (2) positive ¹⁸
 B. (1) positive (2) negative ¹⁷

(Press C for another look at the previous frame.) 2-16~~5~~
¹⁵

17

Incorrect.

A battery plate which contains lead peroxide (PbO₂) and is dark chocolate-brown in color is a **POSITIVE** plate.

A plate which contains sponge lead (Pb) and is gray in color is a **NEGATIVE** plate.

Press A ¹⁶ 2-17

18

OK.

Several plates of each kind are held together by a lead casting called a **PLATE STRAP**. When a plate strap and several identical plates are welded together they are called a **PLATE GROUP**.

Each plate strap casting includes a vertical **TERMINAL POST**.

Press A ¹⁹ 2-18

19

Plate groups of opposite polarity are arranged so that negative plates and positive plates alternate. Each plate is shielded from its neighbor by a **SEPARATOR**, made of non-conductive, microporous material (of cellulose fiber, rubber, plastic and/or fiberglass).

Press A ²⁰ 2-19

20

Each complete group of positive and negative plates, separators, plate straps and terminal posts is called an **ELEMENT** or "**CELL PACK**."

Any number or size of plates may be used, depending on the desired battery capacity. The negative plate group contains one more plate than its corresponding positive plate group.

Press A ²¹ 2-20

21

See Didactor Plate I. This is a top view diagram of a battery element or "cell pack." In this view you can see how the plates are interlaced, and how a separator is placed between each pair of alternate plates.

In Didactor Plate I, (1) is the **NEGATIVE** plate group and (2) is the **POSITIVE** plate group.

A. (1) Plate group (a) (2) Plate group (b) ²³
 B. (1) Plate group (b) (2) Plate group (a) ²² 2-21

22

You are incorrect.

See Didactor Plate I. Look at Plate group (a). Notice that there are **FOUR** battery plates (pointing downward) in this group.

Now look at Plate group (b). In this group notice that there are **THREE** battery plates (pointing upward).

Remember these numbers and press A. 2-22
²⁰

23

Good. Since group (a) has one more plate than group (b), Plate group (a) is the **NEGATIVE** plate group and Plate group (b) is the **POSITIVE** plate group.

The lead peroxide (PbO₂) of the positive plates is more active chemically than the sponge lead (Pb) of the negative plates. Therefore, more negative material is needed in order to keep the overall reaction uniform.

Press A ²⁴ 2-23

24

After the battery element is assembled, it is placed into one CELL of the battery CASE.

The case is made of hard rubber material, with partitions which separate the individual cells. The elements rest on bridges at the bottom of each cell; the bridges form SEDIMENT CHAMBERS which collect material dislodged from the plates during the repeated cycling (charging and discharging) that occurs during the natural life of the battery.

Press A ~~25~~ 2-24

25

After the elements are placed in the cells, hard rubber CELL COVERS are fitted over the terminal posts of each element. The cell covers of most batteries contain lead bushings molded into the hard rubber.

After the covers are installed, CELL CONNECTORS are welded between the intermediate terminal posts (positive of one to negative of the next) to form an internal series circuit.

Press A 26 2-25

26

See Plate II. In part (a) we see how the adjacent cells are connected to form a 6 volt storage battery. Part (b) shows a typical arrangement for a 12 volt battery. Note the cell connectors which link each cell to its neighbors. The battery posts marked NEG and POS are the external terminal posts to which the battery cables are connected.

Press A 27 2-26

27

A 6 volt storage battery consists of (1) cells connected in series; a 12 volt battery consists of (2) series-connected cells.

- A. (1) six (2) three 28
- B. (1) six (2) twelve 28
- C. (1) three (2) six 29

2-27

28

Incorrect.

Take another look at Plate II. In (a), note that there are three cells connected together to form the 6 volt battery.

In (b), note that six cells are needed to form the 12 volt battery.

Press A 29 2-28

29

OK.

Whether in a 6 volt or in a 12 volt battery, the voltage created in each cell of a fully charged battery is approximately _____ volts.

- A. three 30
- B. two 31
- C. one and one-half 30

2-29

30

You are incorrect.

Keep in mind that we are talking about a fully charged battery.

We know that there are three cells in a 6 volt battery. If three cells develop six volts, then one cell will develop six divided by three, or two volts.

Similarly, in a 12 volt battery (which has six cells), twelve divided by six equals two volts per cell.

Press A 31 2-30

31

OK. Each cell of a fully charged battery will provide approximately two volts of emf.

Before we continue, you may want to review what we have covered so far about the construction of batteries. If you would like a brief review, press

A. 13

Otherwise, press B. 33 3-31

X(c)-32

32

OK. Lead-acid storage batteries develop approximately two volts per cell when fully charged.

Let's have a quick review of this section on the construction of the storage battery, since you made an error on one or two questions. When you complete this section without an error, we'll talk about the electrolyte.

Press A 13

2-32

33

The final operation in constructing a battery is to seal the top. In some batteries a sealing compound is poured into the junction between the cell covers and the battery case. This forms a seal around the cell cover surfaces and prevents the electrolyte from leaking out when the battery is filled.

Press A 34

3-33

34

Many modern batteries feature a one-piece cover instead of the conventional sealing compound covering. This one-piece cover reduces the tendency for corrosion to form on the top of the battery.

Batteries with one-piece covers are often called **ENERGIZERS**. Other design features help to reduce the internal circuit voltage drop in these batteries.

Press A 35

3-34

35

In the cover of each battery cell there is a **VENT CAP**, which screws into a threaded hole in the cell cover. The vent cap serves two purposes:

1. It covers the cell opening through which the electrolyte is checked and water is added.
2. It provides a path for the escape of gases (primarily hydrogen) which are formed during charging.

Press A 36

3-35

36

The proper electrolyte level in each cell should be maintained by adding water until the level reaches the bottom of the **SPLIT RING**. Overfilling should be avoided. This prevents any loss of electrolyte which would result in poor performance, corrosion and premature failure.

ESCAPING GASES
VENT HOLE
SPLIT RING
SURFACE OF ELECTROLYTE

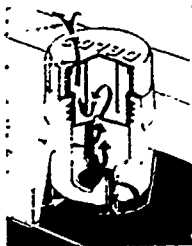

Press A 37

3-36

37

When the surface of the electrolyte is just at the bottom of the split ring, the cell is _____.

- A. overfilled 38
- B. properly filled 39
- C. underfilled 38

3-37

38

No. When the electrolyte level is just at the bottom of the split ring the cell is **PROPERLY FILLED**.

Underfilling may cause the active materials in the plates to become dry and hardened, and cause premature failure.

Overfilling can result in loss of electrolyte and corrosion of external parts.

Press A 39

3-38

39

OK.

We have referred to the sponge lead and lead peroxide of the plates as "active materials." They cannot become truly active, however, until they are covered by electrolyte.

ELECTROLYTE for the lead-acid storage battery is a solution of sulfuric acid (H_2SO_4) and water.

Press A 40

3-39

40

An **ELECTROLYTE** is a liquid which is capable of conducting an electric current.

Electrical energy is produced in the battery by chemical action between the active materials in the plates and the sulfuric acid of the electrolyte.

The electrolyte also conducts the electric current through the separators to the plates.

Press A **41** 3-40

41

The lattice-like wire mesh of the plates then becomes the conductor for the current, which is passed to the cell connectors and ultimately to the positive terminal post.

In a lead-acid storage battery, the electrolyte is

- A. concentrated sulfuric acid **42**
- B. distilled water **42**
- C. a sulfuric acid-water solution **43** 3-41

42

Not quite.

The answer you chose is one of the components of the electrolyte.

Electrolyte for a lead-acid storage battery is made up of a **SOLUTION** of **SULFURIC ACID** and **WATER** (preferably distilled water).

Press A **43** 3-42

43

OK.

The **SPECIFIC GRAVITY** of the electrolyte is of extreme importance in the battery.

Specific gravity of a liquid is a measure of the weight of a given volume of the liquid compared to the weight of that same volume of water. Water is used as a standard and is arbitrarily assigned a specific gravity of 1.000.

Press A **44** 3-43

44

Pure sulfuric acid has a specific gravity of 1.835 (commonly called "eighteen thirty-five"), and is not practical for use as electrolyte.

To be practical for use in the battery, sulfuric acid must be diluted with water to obtain a solution with a specific gravity of about 1.260 ("twelve-sixty"), the recommended specific gravity for electrolyte in many of today's batteries.

Press A **45** 3-44

45

The specific gravity of water is 1.000; fresh sulfuric acid electrolyte has a specific gravity of about 1.260.

This means that in a lead-acid battery, (1) is about 1.26 times as heavy as (2).

- A. (1) electrolyte (2) water **47**
- B. (1) water (2) electrolyte **46**

3-45

46

Incorrect.

The specific gravity of fresh electrolyte is approximately 1.260. By definition, specific gravity means that equal volumes of electrolyte and water have been compared and the electrolyte has been found to be about 1.26 times as heavy as water.

Press A **47** 3-46

47

OK. Electrolyte is slightly heavier than water. The specific gravity of the electrolyte in a battery varies slightly with the **TEMPERATURE** and with the **STATE OF CHARGE** of the battery. We'll talk more about this in the next sections.

If you would like a quick review of our discussion of **ELECTROLYTE**, press A. **33**

Otherwise, press B **49** 4-47

X(C)-48

48

OK. Electrolyte is slightly heavier than water.

Before we get into a detailed discussion of the chemical action in the battery, let's have a brief review of this section on ELECTROLYTE.

You shouldn't have any difficulty with the questions now.

Press A 33 3-48

49

STATE OF CHARGE is the term used to identify a battery's internal condition in relation to a fully-charged unit. The specifications for the specific gravity of a fully charged battery usually fall between 1.260 and 1.300 ("temperature-corrected" to 80 F. We'll talk about this in the next film.)

Press A 50 4-49

50

The efficiency of the battery and its ability to produce electrical energy is affected by the amounts of:

1. lead peroxide in the POSITIVE plates,
2. sponge lead in the NEGATIVE plates and
3. sulfuric acid in the ELECTROLYTE.

Press A 51 4-50

51

During discharge, the sulfuric acid (H_2SO_4) in the electrolyte is broken down. The SULFATE ION (SO_4) portion is absorbed by both the positive and the negative plates, and combines with lead to form lead sulfate ($PbSO_4$).

Since this is true, it is possible to calculate the remaining electrical potential in a battery at a given time by determining the acid content left in the electrolyte.
Press A 52 4-51

52

The three basic ingredients of a lead-acid storage battery are:

1. Lead peroxide (PbO_2) POS plates
2. Sponge lead (Pb) NEG plates
3. Electrolyte: Sulfuric acid (H_2SO_4) and Water (H_2O)

Electrical potential of the battery (state of charge) is greatest when there is (1) the greatest DIFFERENCE between the chemical composition of the positive plates and the negative plates, and (2) a relatively high percentage of sulfuric acid in the electrolyte.

Press A 53 4-52

53

As the battery discharges, the positive and negative plates become (1) _____ chemically, and the sulfuric acid content of the electrolyte (2) _____

- | | |
|-------------------|------------------|
| A. (1) more alike | (2) increases 54 |
| B. (1) more alike | (2) decreases 56 |
| C. (1) less alike | (2) decreases 57 |
| D. (1) less alike | (2) increases 55 |

4-53

54

You are only partly correct.

During discharge, both the positive and negative plates absorb sulfate ions (SO_4). These combine with the lead (Pb) in each kind of plate to form lead sulfate ($PbSO_4$).

So during discharge, the plates become MORE ALIKE chemically. The sulfuric acid content DECREASES during discharge because the acid is giving up its sulfate ions to the plates.

Press A 56 4-54

55

You are incorrect.

As the battery discharges, both the positive and the negative plates absorb sulfate ions (SO_4) from the electrolyte. These combine with the lead (Pb) in each kind of plate to form lead sulfate ($PbSO_4$). This means that the plates become MORE ALIKE chemically during discharge.

It also means that the sulfuric acid content of the electrolyte DECREASES during discharge, because the acid is giving up some of its sulfate ions to the plates. Press A 52 4-55

56

OK. Some of the sulfate ions in the electrolyte are absorbed by the plates during discharge. This causes the plates to become more alike chemically (and so they become less able to produce voltage).

As the sulfate ions are given up, the specific gravity of the electrolyte is LOWERED.

Press A 57

4-56

57

See Plate III, part (a). This diagram shows what occurs in the battery during the discharge cycle. Current flows from the POSITIVE terminal post to the starting motor, lights, horn, radio and other accessories.

Note that, as the battery discharges, the specific gravity of the electrolyte is lowering, and lead sulfate is accumulating on both the positive and negative plates.

Press A 58

4-57

58

See Plate III, part (b). Discharging has continued here until the battery has become completely discharged. The electrolyte specific gravity is at its lowest point, and the lead sulfate deposits on the positive and negative plates are at their heaviest.

The OPEN CIRCUIT VOLTAGE (OCV), which is taken by a voltmeter placed across the external terminals, is at its lowest reading.

Press A 59

4-58

59

True or False:

Adding more sulfuric acid to a discharged battery will raise the specific gravity of the electrolyte, and will bring the battery "back to life."

- A. The statement is completely true. 60
- B. The statement is completely false. 60
- C. The statement is partially true. 61

4-59

60

You are incorrect.

The correct answer is: "The statement is PARTIALLY true."

Adding more sulfuric acid to the electrolyte will NOT bring the battery "back to life" -- it will not restore the battery to a charged condition.

Press A 61

4-60

61

OK. The statement was partially true. Adding more sulfuric acid WILL raise the specific gravity of the electrolyte. But this is of no practical value!

Merely raising the specific gravity WILL NOT bring the battery back to a useful charged condition. This can only be accomplished by passing a CHARGING current through the battery, in the opposite direction from the discharge current.

Press A 62

4-61

62

Before you study the charging cycle, if you would like to review the DISCHARGE cycle, press A. 49

The chemical reactions that occur within the battery during the CHARGING cycle are basically the reverse of what occurs during discharge.

During charge, direct current (DC) is passed from an external source (a generator, alternator, or other charging device) through the POSITIVE terminal post.

Press B ~~64~~ 64

X(C)-63

5-62

63

You've had a little trouble with at least one question in this section, so let's have a brief review before we go on to discuss the charging cycle.

We'll continue when you answer both questions correctly.

Press A 49

4-63

64

See Plate III, part (c). As the CHARGING current passes into the battery, sulfate ions are driven out of the lead sulfate deposits on the positive and negative plates. Also, the water in the electrolyte is split up into hydrogen and oxygen gases.

The liberated sulfate ions recombine with the hydrogen to form sulfuric acid (H_2SO_4) again. The oxygen recombines with the lead of the positive plates to form lead peroxide (PbO_2) again.

Press A 65

5-64

65

As the charge in the battery cell nears completion, hydrogen gas (H_2) is liberated at the negative plates and oxygen (O_2) is liberated at the positive plates.

This is called GASSING. It occurs because the charging current is greater than needed to convert the small remaining amounts of lead sulfate on the plates.

Press A 66

5-65

66

As gassing occurs, you might say that some of the water in the electrolyte is being "used up" (driven off in gaseous form).

Since there is now less water and more sulfuric acid in the electrolyte, the specific gravity of the electrolyte will be _____.

- A. increased 68
- B. decreased 67

5-66

67

Incorrect. See Plate III, part (c).

During the charging cycle, more and more sulfuric acid is formed in the electrolyte as the plates give up sulfate ions. At the same time, water is being converted into hydrogen and oxygen gas (liberated at the plates).

More sulfuric acid and less water means INCREASED specific gravity for the electrolyte.

Press A 68

5-67

68

OK.

As water breaks down into hydrogen and oxygen gas during charging, it escapes to the atmosphere through the battery vent caps. Water is also lost through normal evaporation.

This water must be replaced periodically. If it is not, the electrolyte level will fall below the tops of the plates and expose them to the air.

Press A 69

5-68

69

If the electrolyte level falls below the tops of the plates, the exposed active materials will become dry and hardened. The greater the area of plates exposed to the air, the less will be the capacity of the battery to produce current.

Allowing the electrolyte level to fall also causes over-concentration of the electrolyte. This increases the action of acid on the plates unnecessarily, and thereby shortens the life of the battery. Over-concentrated electrolyte also attacks the separators.

Press A 70

5-69

70

In this setup, (1) _____ has the GREATEST current-producing capacity; (2) _____ has the LEAST capacity.

- 71 A. (1) plate (a) (2) plate (c)
- 73 B. (1) plate (b) (2) plate (c)
- 72 C. (1) plate (c) (2) plate (b)

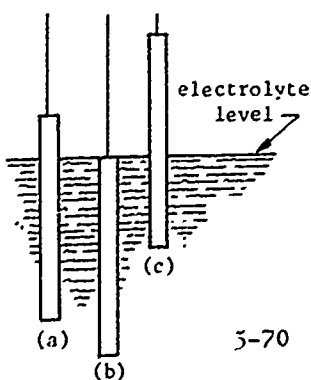

5-70

71

Only part of your answer is correct.

Plate (c) has the greatest area exposed to air, so it has the LEAST capacity to produce current.

Which plate has the least area exposed to the air?

Try the question again. Press A 70

5-71

72

You are incorrect.

You may have missed the information that would help you answer the last question.

We said that the GREATER the area of a plate exposed to the air, the LESS will be the capacity of that plate to produce current.

Keep this rule in mind and try the question again.

Press A 70

5-72

73

Good. It is important to keep the battery plates submerged in electrolyte.

See Plate III, part (d).

In a fully charged battery, the surfaces of the positive plates are pure lead peroxide (PbO_2), and the negative plates are pure lead (Pb). Also, the specific gravity of the electrolyte is at its maximum value.

Press A 74

5-73

74

At full charge, the materials of both the positive plates and the negative plates are porous, and they absorb liquids like a sponge does.

The tiny pores become filled with electrolyte, thus increasing the total surface area of the plates in contact with the electrolyte. This helps to increase the voltage potential.

Press A 75

5-74

75

As the lead-acid storage battery is charged, the positive and negative plates become (1) chemically, and the specific gravity of the electrolyte (2).

- | | |
|-------------------|------------------|
| A. (1) more alike | (2) increases 77 |
| B. (1) more alike | (2) decreases 76 |
| C. (1) less alike | (2) decreases 77 |
| D. (1) less alike | (2) increases 78 |

5-75

76

You are incorrect.

You said that, in charging, the plates become more alike chemically and the specific gravity of the electrolyte decreases. That is a description of what happens during DIScharge.

As the battery is charged, the OPPOSITE of the above actions takes place -- the plates become more alike chemically and the specific gravity of the electrolyte increases.

Press A 75

5-76

77

Only part of your answer is correct.

As the battery is charged, the positive plates give up sulfate ions in exchange for oxygen in the electrolyte, to become lead peroxide again.

The negative plates also give up sulfate ions, to become sponge lead again. So, the plates become LESS ALIKE.

As sulfate ions are added to the electrolyte solution, the specific gravity INCREASES.

Press A 79

5-77

78

OK. The greater the chemical difference between the positive plates and the negative plates, the greater the electrical potential will be when the plates are immersed in electrolyte of the proper specific gravity.

If you would like to review the CHARGING cycle, press A. 62

Otherwise, press B. 80

5-78

X(c)-79

79

OK. The electrical potential is greatest when there is the greatest chemical difference between the positive plates and the negative plates.

Since you have made an error or two on the questions in this section, let's review the charging cycle now.

Press A 62

5-79

80

The CHARGING SYSTEM in an automotive vehicle consists of the battery, the generator (or alternator), the regulator and all necessary wiring.

The BATTERY CHARGING VOLTAGE is the voltage measured across the battery terminals (posts) by a voltmeter while the generator is charging the battery.

Press A 81

6-80

81

Battery charging voltage must be sufficient to overcome two factors:

1. The battery "CEMF" (Counter-ElectroMotive Force), plus
2. The "IR_b" (voltage drop caused by the Internal Resistance in the battery)

$$\text{CEMF} + \text{IR}_b = \text{MINIMUM BATTERY CHARGING VOLTAGE}$$

Press A 82

6-81

82

CEMF is the battery counter-electromotive force -- the voltage produced within the battery by chemical means which OPPOSES the battery charging voltage. CEMF must be overcome before the battery will "take a charge."

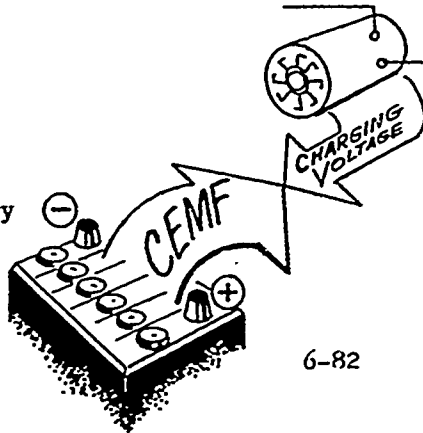

Press A 83

6-82

83

IR_b, the internal resistance in the battery, consists of the normal resistance to current flow that exists in the internal battery parts, in the electrolyte itself, and around the plates that are "filmed over" during gassing or "sulfated" during discharge.

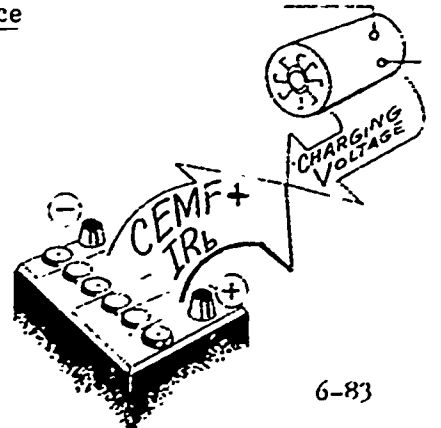

Press A 84

6-83

84

Generator voltage (battery charging voltage), must be _____ CEMF + IR_b in order for the battery to accept a charge.

- A. lower than 85
- B. the same as 85
- C. higher than 86

6-84

85

No. CEMF and IR_b oppose the force of the generator voltage (the battery charging voltage). The generator voltage must overcome the CEMF and the IR_b.

Therefore the generator voltage must be HIGHER THAN the CEMF + IR_b in order to charge the battery.

Press A 86

6-85

86

OK. When the battery charging voltage (generator voltage) overcomes the CEMF and the IR_b, the battery will accept a charge.

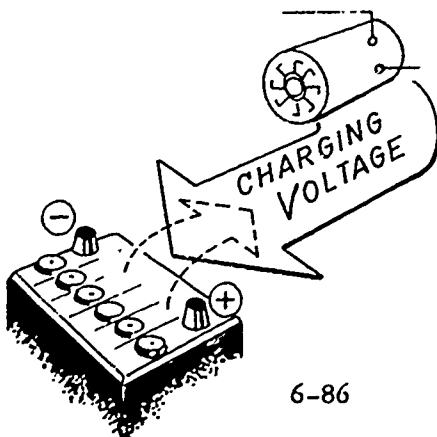

Press A 87

6-86

87

Since the STATE OF CHARGE of the battery has an important effect on the battery CEMF, the state of charge affects battery charging voltage and the charge rate (in amperes).

As the state of charge INCREASES, battery CEMF INCREASES also.

Press A 88

6-87

88

As the state of charge increases, the VOLTAGE REGULATOR becomes important. The regulator functions to protect the battery and other accessories from excess voltage.

Battery CEMF _____ as the state of charge increases.

- A. increases 90
- B. remains constant 89
- C. decreases 89

6-88

89

Incorrect.

State of charge and battery CEMF are directly proportional factors. Take a look at the preceding frame and then try the question again.

Press A 87

6-89

90

OK. When the battery is in a relatively high state of charge, the CEMF also is high. This means that the battery can accept only a LOW rate of charge.

The regulator setting must match the charge requirements of the battery. It must protect the battery from overcharging and overheating.

Press A 91

6-90

91

A battery in a high state of charge will have
 (1) _____ CEMF and will require a
 (2) _____ rate of charge.

- A. (1) low (2) high 92
- B. (1) high (2) low 93
- C. (1) low (2) low 92

6-91

92

You are incorrect.

Remember that a battery in a high state of charge also has a high CEMF.

In such a state, the battery will accept only a LOW rate of charge. Otherwise, it would overcharge and overheat.

Press A 93

6-92

93

OK.

On the other hand, a battery in a LOW state of charge will have (1) _____ CEMF; and will accept a (2) _____ rate of charge.

- A. (1) low (2) high 95
- B. (1) high (2) low 94
- C. (1) high (2) high 94

6-93

94

Incorrect.

Since state of charge and CEMF are directly proportional, a high state of charge means a high battery CEMF also.

A battery in a low state of charge will accept a relatively HIGH rate of charge.

Press A 95

6-94

95

OK. The regulator "senses" and is affected by the state of charge of the battery. The regulator limits generator voltage, depending on the requirements of the battery at any given time.

The regulator also protects the battery against undesirable combinations of charging voltage and charging rate.

If you would like to review State of Charge and Battery Charging Voltage, press A. Otherwise, press B.

97 X(c)-96

7-95

96

OK. A battery in a low state of charge will have a low CEMF, and consequently will accept a HIGH rate of charge.

The relationship between battery charging voltage and state of charge is very important. Let's have a quick review, since you missed a question or two.

Press A 85

6-8

97

Battery TEMPERATURE also has a definite effect on the charging voltage and the charging rate, primarily because of the effect that temperature has on the RESISTANCE (or resistivity) of the electrolyte.

As the temperature of the electrolyte DEcreases, the resistance of the electrolyte INcreases.

Press A 98

7-97

98

The colder the electrolyte in a battery, the _____ the resistance of the electrolyte.

- A. lower 99
- B. higher 100

99

Incorrect.

Electrolyte temperature and electrolyte resistivity are INVERSELY proportional factors.

This means that as one goes up, the other goes down.

Press A to try the question again. 98

7-99

100

OK. Since the resistivity of the electrolyte is one factor which affects the IR_p (internal resistance in the battery), electrolyte resistivity will also affect the charging voltage. Minimum charging voltage = CEMF + IR_p .

A cold battery will have _____ (1) _____ electrolyte resistance and will be _____ (2) _____ to charge.

- A. (1) high (2) easy 101
- B. (1) low (2) easy 101
- C. (1) high (2) hard 102 7-100

101

Incorrect.

A cold battery, with low electrolyte temperature, will have HIGH resistance (IR_p). This means that a greater charging voltage will be needed, to overcome the increased resistance. The cold battery will be relatively HARD to charge.

Press A 102

7-101

102

OK. Conversely, the electrolyte resistivity in a hot battery will be _____ (1) _____, and the battery will be _____ (2) _____ to charge.

- A. (1) high (2) easy 103
- B. (1) low (2) easy 104
- C. (1) high (2) hard 103

7-102

103

Incorrect.

Since electrolyte temperature (battery temperature) and electrolyte resistance (IR_p) are inversely proportional, high electrolyte temperature means LOW electrolyte resistance.

A battery with high electrolyte temperature will be relatively EASY to charge.

Press A 104

7-103

104

OK. A hot battery will accept a charge more readily than a cold battery.

Keeping in mind that the charging voltage and the charging rate must be adjusted to protect the battery from overcharging and overheating, a warm battery should be charged at a relatively _____ rate.

- A. low 106
- B. high 105

7-104

105

Incorrect.

A warm battery will have relatively high electrolyte temperature, and will accept a charge readily.

In order to protect against overcharging and overheating, the warm battery should be charged at a relatively LOW rate.

Press A 104

7-105

106

That is correct. A warm battery should be charged at a relatively low rate -- particularly if it is already in a relatively high state of charge.

A cold battery in a low state of charge should be charged at a relatively _____ rate.

- A. low 107
- B. high 108

7-106

107

No.

There are two factors to consider here -- temperature and state of charge.

A cold battery means low electrolyte temperature. This means high resistance; so a relatively HIGH rate of charge is needed.

A low state of charge means low CEMF; so the battery will accept a relatively HIGH rate of charge.

Press A 108

7-107

108

OK. The battery is cold (high resistance); so it **REQUIRES** a high rate of charge.

The battery is in a low state of charge (low CEMF); so it will **ACCEPT** a high rate of charge.

When a battery is in a condition where it both requires a certain rate of charge and will accept that charge without danger of damage, then that particular rate of charge is preferred.

Press A 109

7-108

109

In areas of severe climatic conditions it may be necessary to adjust the voltage regulator setting in order to maintain a full charge on the vehicle batteries.

If the environment is consistently cold it may be necessary to **RAISE** the regulator setting in order to maintain a satisfactory state of charge.

In hot climates the regulator setting must sometimes be **LOWERED** to prevent overcharge, and excessive loss of water.

Press A 110

7-109

110

In areas of extreme cold weather it may be necessary to _____ the voltage regulator setting in order to maintain a fully charged battery.

- A. raise 112
- B. lower 111

7-110

111

You are incorrect.

In an excessively **HOT** climate it may be necessary to **LOWER** the voltage regulator setting, in order to prevent overcharging and excessive loss of water.

What about a **COLD** climate, now?

Press A 110

7-111

112

Good. In some areas, voltage regulators are used which operate automatically -- they provide higher regulator settings in cold weather and lower settings during the warmer months. These are called temperature compensators.

If you would like to review the effects of temperature on charging rate and charging voltage, press A. 97
Otherwise, press B. 114

X(C)-113

7-112

114

Congratulations!

You have successfully completed this film, "Automotive Batteries I -- Introduction to the Lead-Acid Storage Battery. "

In the next film we will study battery TESTING and SERVICING.

Press REWIND.

7-114

113

OK.
Let's have a quick review, now, of the effects of temperature on charging rate and charging voltage, since you made an error or two on the questions.

Take your time; read carefully. Press A 97

7-113

INSTRUCTOR'S GUIDE

Title of Unit: LEARNING ABOUT BATTERY SERVICING AND TESTING (PART I) AM 2-12
9/7/67

OBJECTIVES for this Unit:

1. To familiarize the student with construction of batteries, and procedures recommended by the American Association of Battery Manufacturers in battery installation, servicing and testing.
2. To assist all personnel engaged in servicing of storage batteries. It also is intended as a reference guide to training information available from other manufacturers on the subject of automotive type lead-acid storage batteries.
3. To introduce information to the student about factors affecting battery life, and methods of predicting battery life.
4. To let the student become aware of the hazards involved in working with and around batteries. (Safety Precautions)

LEARNING AIDS suggested:

Visual Aids:

Delco-Remy training charts and manuals
No. 5133-B; Storage Batteries

Models:

Any cells, elements, plates, or complete batteries prepared in advance for classroom demonstration. (Acid removed and plates washed and dried.)
Demonstration in use of hydrometer, voltmeter, and other test equipment used on batteries.

QUESTIONS FOR DISCUSSION AND GROUP PARTICIPATION:

1. What type of energy does a battery store?
2. What is meant by the term "chemically active materials?"
3. What is the purpose of the separators?
4. What is an element?
5. What is the primary difference between the "energizer" and the conventional (older type) battery?
6. How many cells make up a 12 volt battery?
7. What process takes place in the battery to produce electrical energy?
8. What limits the amount of electrical energy a battery can produce?
9. What type of current is used to recharge a battery? (Low voltage DC, high voltage DC, low voltage AC, or high voltage AC?)

10. What effect does the accumulation of lead sulfate on battery plates have on the battery?
11. What happens to the water in a battery?
12. What type of water is best for batteries? Why?
13. In what direction should a battery be recharged? Same as during discharge or opposite to that during discharge?
14. Why is it necessary to control generator charging current and voltage?
15. Does battery voltage and its state of charge have any effect on the charging rate? (On battery, generator, and regulator installation?)
16. How is battery charging voltage determined?
17. What is meant by the term "counter-electromotive force?"
18. What effect does temperature have on batteries?
19. What is meant by the term "tailor the voltage regulator setting?"
20. What may be determined from a hydrometer reading, regarding the condition of the battery?