

R E P O R T R E S U M E S

ED 021 088

VT 005 671

AUTOMOTIVE DIESEL MAINTENANCE 1. UNIT XVII, I--MAINTAINING
THE LUBRICATION SYSTEM--CUMMINS DIESEL ENGINE, II--UNIT
INSTALLATION AND REMOVAL--DRIVE LINES.

HUMAN ENGINEERING INSTITUTE, CLEVELAND, OHIO

REPORT NUMBER AM-1-17

PUB DATE 24 MAY 66

MINNESOTA STATE DEPT. OF EDUCATION, ST. PAUL

EDRS PRICE MF-\$0.25 HC-\$2.24 54P.

DESCRIPTORS- *STUDY GUIDES, *TEACHING GUIDES, *TRADE AND
INDUSTRIAL EDUCATION, *AUTO MECHANICS (OCCUPATION), *DIESEL
ENGINES, ADULT VOCATIONAL EDUCATION, TRANSPARENCIES,
PROGRAMED MATERIALS, INDIVIDUAL INSTRUCTION, INSTRUCTIONAL
FILMS, PROGRAMED INSTRUCTION, MOTOR VEHICLES, EQUIPMENT
MAINTENANCE, KINETICS,

THIS MODULE OF A 30-MODULE COURSE IS DESIGNED TO DEVELOP
AN UNDERSTANDING OF THE DIESEL ENGINE LUBRICATION SYSTEM AND
THE PROCEDURES FOR REMOVAL AND INSTALLATION OF THE DRIVE LINE
USED IN DIESEL ENGINE POWER DISTRIBUTION. TOPICS ARE (1)
PROLONGING ENGINE LIFE, (2) FUNCTIONS OF THE LUBRICATING
SYSTEM, (3) TRACING THE LUBRICANT FLOW, (4) DETERMINING
LUBRICATION SYSTEM FAILURES, (5) MAINTAINING LUBRICATION
SYSTEM COMPONENTS, (6) LEARNING ABOUT OIL TESTS, (7) FIELD
TESTING OF OIL, (7) DRIVE LINE DESCRIPTION, (8) REMOVAL OF
DRIVE LINE, AND (9) TROUBLESHOOTING (DRIVE LINE). THE MODULE
CONSISTS OF A SELF-INSTRUCTIONAL BRANCH PROGRAMED TRAINING
FILM "UNDERSTANDING DIESEL ENGINE LUBRICATION SYSTEMS" AND
OTHER MATERIALS. SEE VT 005 655 FOR FURTHER INFORMATION.
MODULES IN THIS SERIES ARE AVAILABLE AS VT 005 655 - VT 005
684. MODULES FOR "AUTOMOTIVE DIESEL MAINTENANCE 2" ARE
AVAILABLE AS VT 005 685 - VT 005 709. THE 2-YEAR PROGRAM
OUTLINE FOR "AUTOMOTIVE DIESEL MAINTENANCE 1 AND 2" IS
AVAILABLE AS VT 006 006. THE TEXT MATERIAL, TRANSPARENCIES,
PROGRAMED TRAINING FILM, AND THE ELECTRONIC TUTOR MAY BE
RENTED (FOR \$1.75 PER WEEK) OR PURCHASED FROM THE HUMAN
ENGINEERING INSTITUTE, HEADQUARTERS AND DEVELOPMENT CENTER,
2341 CARNEGIE AVENUE, CLEVELAND, OHIO 44115. (HC)

STUDY AND READING MATERIALS

AUTOMOTIVE

DIESEL

1

MAINTENANCE

- I -- MAINTAINING THE LUBRICATION SYSTEM - CUMMINS DIESEL ENGINE
- II -- UNIT INSTALLATION AND REMOVAL -- DRIVE LINES

UNIT XVII

TABLE OF CONTENTS

PART I

- SECTION A PROLONGING ENGINE LIFE
- SECTION B FUNCTIONS OF THE LUBRICATING SYSTEM
- SECTION C TRACING THE LUBRICANT FLOW
- SECTION D DETERMINING LUBRICATION SYSTEM FAILURES
- SECTION E MAINTAINING LUBRICATION SYSTEM COMPONENTS
- SECTION F LEARNING ABOUT OIL TESTS
- SECTION G FIELD TESTING OF OIL

PART II

- SECTION A DRIVE LINE DESCRIPTION
- SECTION B REMOVAL OF DRIVE LINE
- SECTION C TROUBLESHOOTING

AM 1-17
5/24/66

Human Engineering
Institute

Minn. State Dept. of Ed.
Vocational Education

U.S. DEPARTMENT OF HEALTH, EDUCATION & WELFARE
OFFICE OF EDUCATION

THIS DOCUMENT HAS BEEN REPRODUCED EXACTLY AS RECEIVED FROM THE PERSON OR ORGANIZATION ORIGINATING IT. POINTS OF VIEW OR OPINIONS STATED DO NOT NECESSARILY REPRESENT OFFICIAL OFFICE OF EDUCATION

HUMAN ENGINEERING INSTITUTE

ED021088

VT00567

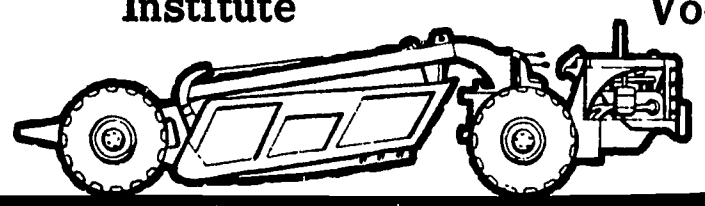
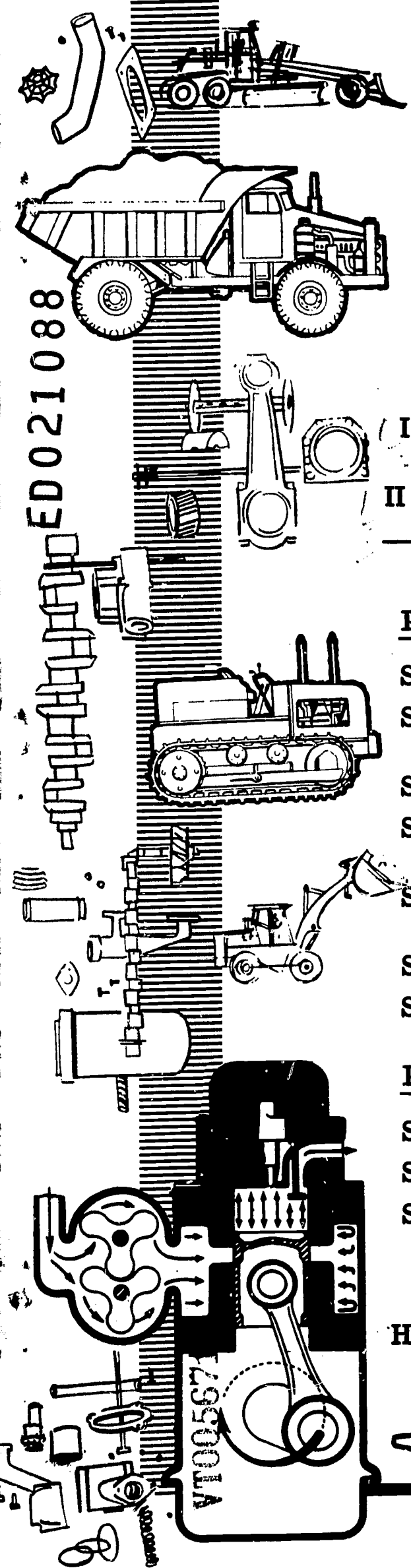

This unit is presented in two parts. The first part covers the operation of the Cummins Diesel lubrication system and its related components. The second part covers a brief description of the drive lines on all trucks and the proper procedure for installing and removing them.

I -- MAINTAINING THE LUBRICATION SYSTEM CUMMINS DIESEL ENGINE

SECTION A -- PROLONGING ENGINE LIFE

Of the four flows in a diesel engine -- air, coolant, fuel, and lubricant -- lubricant is perhaps the most important in prolonging the life of the engine.

Engine rebuilding is made necessary by only one thing -- wear. If pistons, rings, main and connecting rod bearings, camshaft bearings, valves, valve seats and other parts of an engine could operate absolutely friction-free, there would be little or no wear and, therefore, no reason for engine rebuilding. This, of course, is a theoretical situation which could not exist in practice. Ambient temperatures, air pressures and engine loads vary. These conditions, coupled with the inevitable presence of small quantities of dust, dirt and metal particles, make "perfect" lubrication impossible.

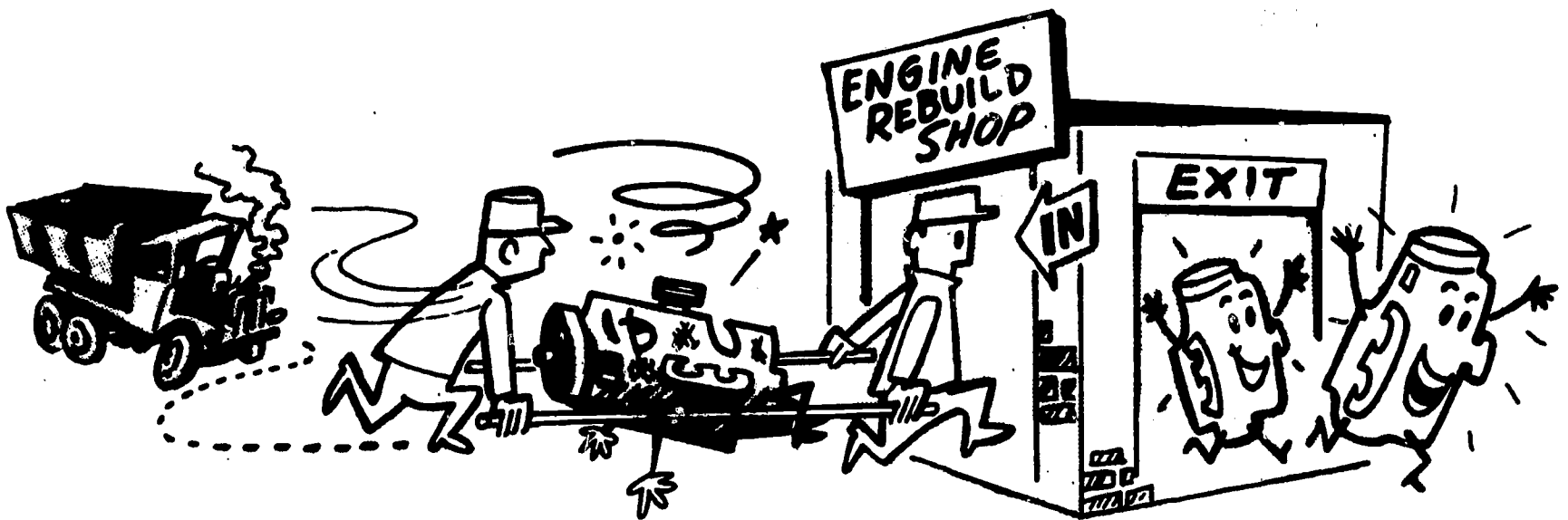

How much and how rapidly an engine wears depends greatly on the efficiency of the engine's lubricating system and on the type and quality of lubricant used. Therefore, the care and manner in which the lubricating system is maintained is one of the major determining factors of engine life after rebuild.

Maximum engine life not only depends on an efficient lubricating system, but the maintenance mechanic, too, is responsible to see that the engine is filled with a suitable grade of lubricating oil, that the strainers, filters and oil coolers are properly serviced, and that the oil is changed at regular intervals.

SECTION B -- FUNCTIONS OF THE LUBRICATING SYSTEM

Perhaps the best way to describe and illustrate the functions and requirements of an engine's lubricating system is to compare it with the circulatory system of the human body. The two systems are quite similar, both in functions and in importance.

In an internal combustion engine, a lubricant must be brought into contact with the various moving parts of the engine to perform five basic functions. They are:

1. Reducing friction
2. Cooling
3. Sealing
4. Preventing rust
5. Scavenging

These same functions (except No. 4) are performed by the blood and the body's circulatory system.

If the body's circulatory system did not provide fluid to lubricate the

moving joints and organs of our bodies, we would be unable to walk, work, or for that matter, exist. By the same token, if the lubricating system of an engine did not supply oil to the moving parts, FRICTION would cause rapid wear, and the life of the engine would be extremely short.

FRICTION - Just what is friction, and how does lubrication fight this menace of machinery that has plagued man for centuries? Suppose we take a close look at our friend, the piston, rubbing against the cylinder wall in the picture.

To the naked eye it would seem that the surfaces are flat. However, under a microscope, see Figure 1, we see that there are minute peaks and valleys which interlock and which prevent the surfaces from sliding freely.

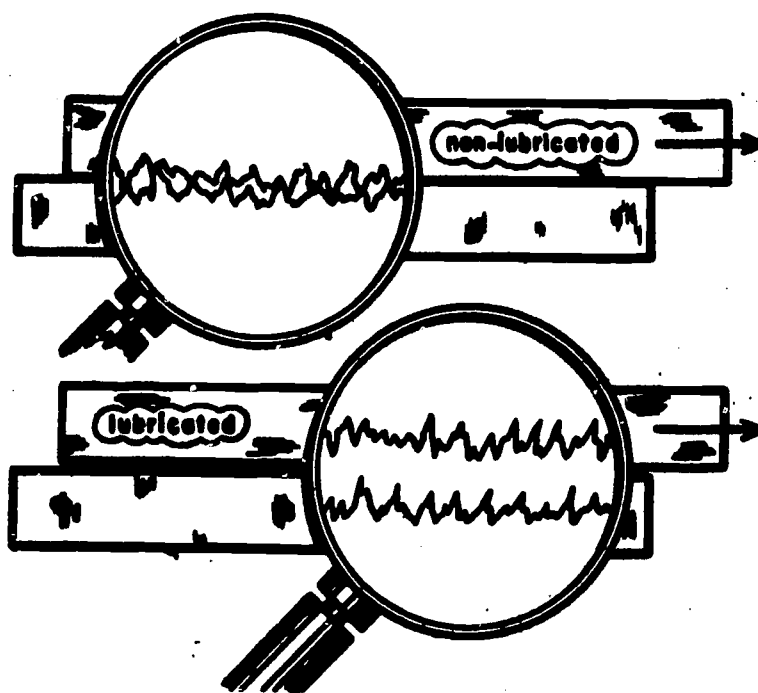
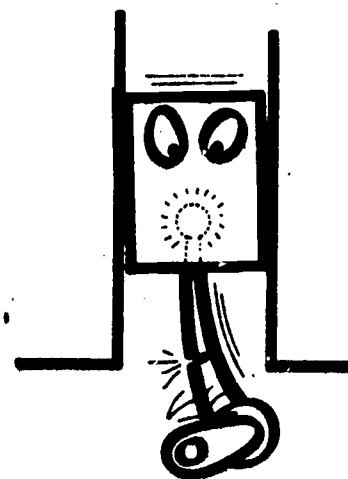

Fig. 1 Cause of friction.

When oil is present between the surfaces, the surfaces are separated and the small peaks and valleys can no longer interlock. This allows the surfaces to slide freely over each other.

This also explains the manner in which a lubricant REDUCES WEAR. If the surfaces were not lubricated, some of the small peaks would be broken off as one surface moves over the other. Eventually, this would result in visible wear on both surfaces.

COOLING is another important function of the body's circulatory system. Like an engine, the harder we work, the greater the heat that is generated in our bodies. Excess heat is carried by blood vessels to the surface of the body, where it is transferred by radiation to the atmosphere. In this way, our circulatory system helps maintain our body temperatures at 98.6F.

Cooling is also one of the important functions of an engine's lubricating system. Lubricating oil must absorb frictional heat produced by moving parts, as well as heat created by combustion. Temperatures in the combustion chamber often reach as high as 4,000F. Heat transferred to engine parts must be carried off. This cooling function is accomplished by the lubricant. Once it has absorbed engine heat, it transmits that heat to the engine water jackets, carries it to the oil pan where it is radiated to the atmosphere, or carries it to an oil cooler where it is transferred to the engine coolant. Figure 2 shows how heat is absorbed by oil.

EXCESSIVE HEAT - It is normal for oil in a diesel engine to become warm after a period of operation. However, as we learned in the last unit, AM 1-15, on the cooling system, if the oil gets too hot, it will break down and cease to lubricate. Remember: **EXCESSIVE HEAT** is a danger signal and the system(s) should be checked immediately to determine the cause. This situation can be compared to a person have a high fever - which indicates an abnormal condition requiring attention and treatment.

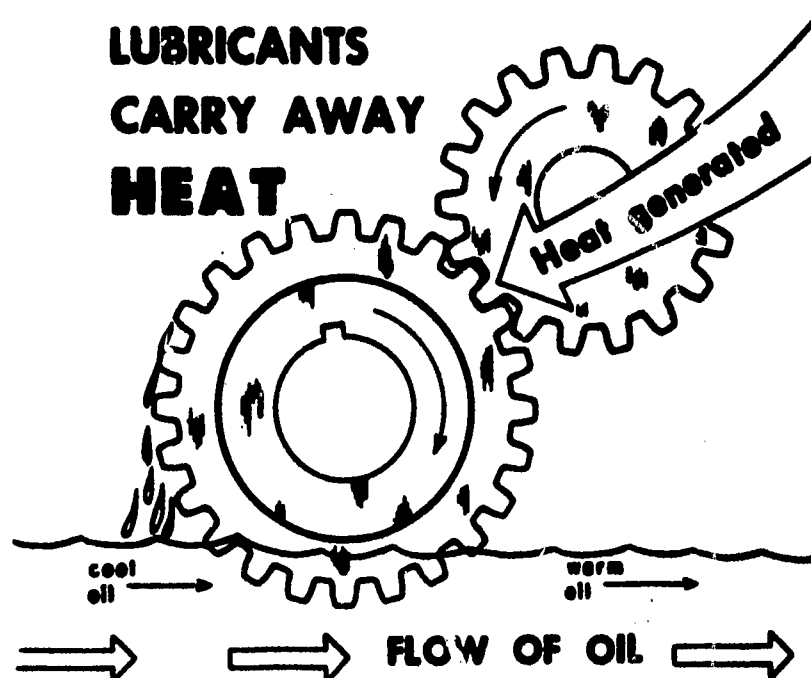
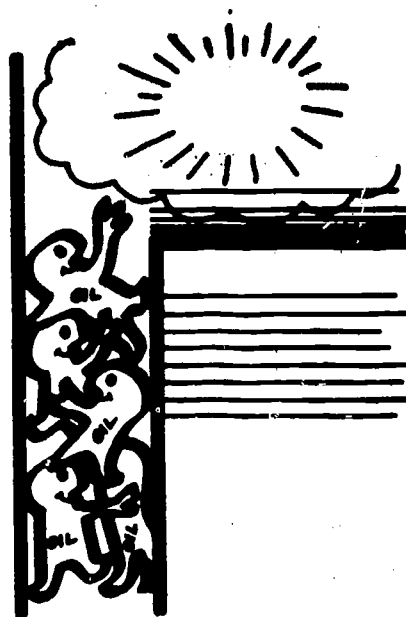

Fig. 2 Oil absorbing heat

SEALING - Blood in the circulatory system also performs a sealing function. This is evident when you cut yourself. The blood coagulates to prevent continuous bleeding.

The lubricating system performs a sealing action which enables the piston rings to perform their main function efficiently. This function is to maintain a gastight seal between the piston and the cylinder walls, in order to keep expanding combustion gases within the combustion chamber, where they can force the piston downward and produce useable powers.



Although piston rings and cylinder walls are very closely fitted, sealing would not be adequate without an oil

film between these parts; therefore, the energy of expanding combustion gases would be wasted.

PREVENTS RUST - When machinery or machine parts are exposed to air and moisture, we know that rust occurs. The presence of a film of lubricant on bearings, gears and machine parts prevents rust from forming so rapidly. For this reason, bearings and gears kept in storage should be coated with a rust preventive material.

SCAVENGING - Scavenging, of course, is one of the primary functions of the circulatory system. The blood picks up impurities throughout the body and transports them to the kidneys, liver, lymph nodes and lungs, where they are dissipated.

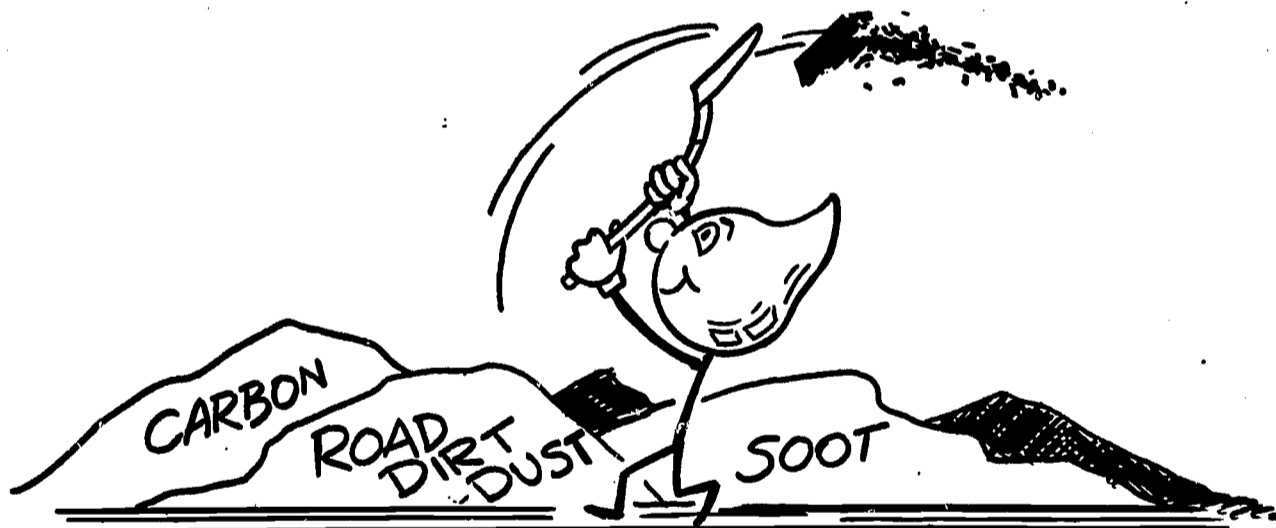

Lubricating oil must also be capable of carrying away or scavenging many different types of impurities efficiently. By-products of combustion are continually being formed during fuel ignition and combustion. Acid is produced by the chemical breakdown of fuel. Water is released from

burned fuel in the form of a vapor or steam. Invisible metal particles are literally "blasted" from the combustion chamber surfaces. And carbon particles are formed by incomplete combustion. All of these by-products of combustion are harmful to an engine if they are allowed to remain on bearing surfaces. An effective lubricating oil contains the necessary additives to remove these by-products and keep the engine parts clean and operation efficiently.

SECTION C -- TRACING THE LUBRICANT FLOW

Not only are the functions of an engine's lubricating system parallel to those of the circulatory system of the body, but also the requirements for each system to perform these functions are similar. Each system, for instance, requires a pump. The circulatory system has the heart, and the Cummins engine lubricating system has the gear-type lubricating oil pump.

To transport blood from one part of the body to another, the circulatory system contains large and small arteries, capillaries and veins. The lubricating system uses large and small oil passages and a lubricating oil sump, see Figure 3.

If the arteries or veins of the body are too small, too large, or become clogged, health and even life itself could be affected. If the oil drillings in an engine are clogged or obstructed in any way, engine operation will be seriously affected. Therefore, cleaning, inspection, and rebuild of the lubricating system of an engine must be given the most careful attention.

FLOW OF OIL THROUGH THE VT-12-700 - The path which the lubricating oil follows, as it is forced through the lubricating system of a Cummins engine, varies somewhat with each engine series. For purposes of this

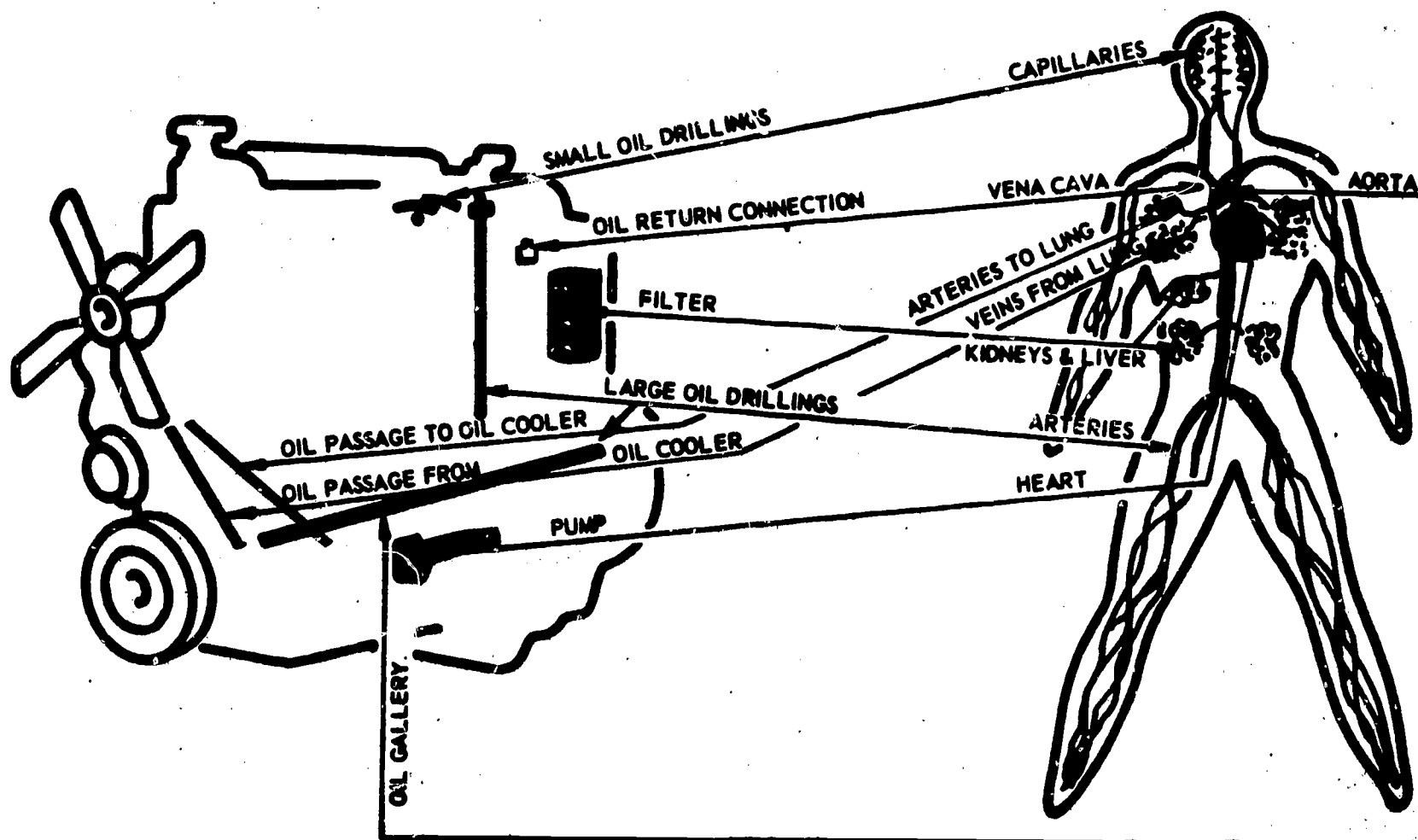

Fig. 3 Comparing man with engine.

unit, we will discuss only the lubricating system and associated components of the VT-12-700 Cummins engine. Check the maintenance manual for other engine series flows.

Cummins V-12 series engines are pressure lubricated. The pressure being supplied by a simple gear type lubricating oil pump located on the fuel pump side of the engine, which is gear or coupling driven from the engine gear train.

Figure 4 shows the oil flow through a VT-12-700 Cummins engine.

A by-pass valve is provided in the full flow oil filter as a safety precaution to allow oil to flow if the filter is clogged.

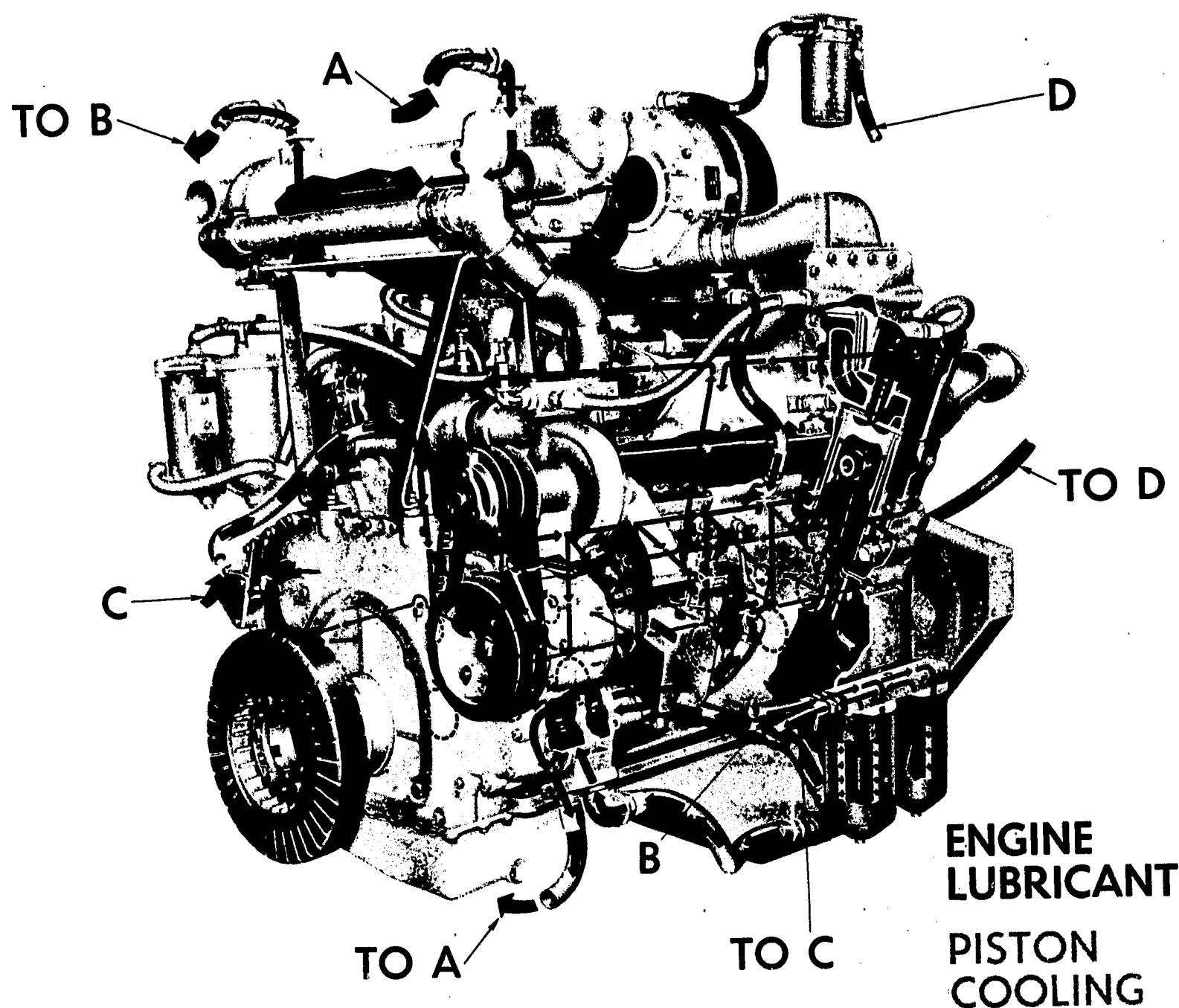
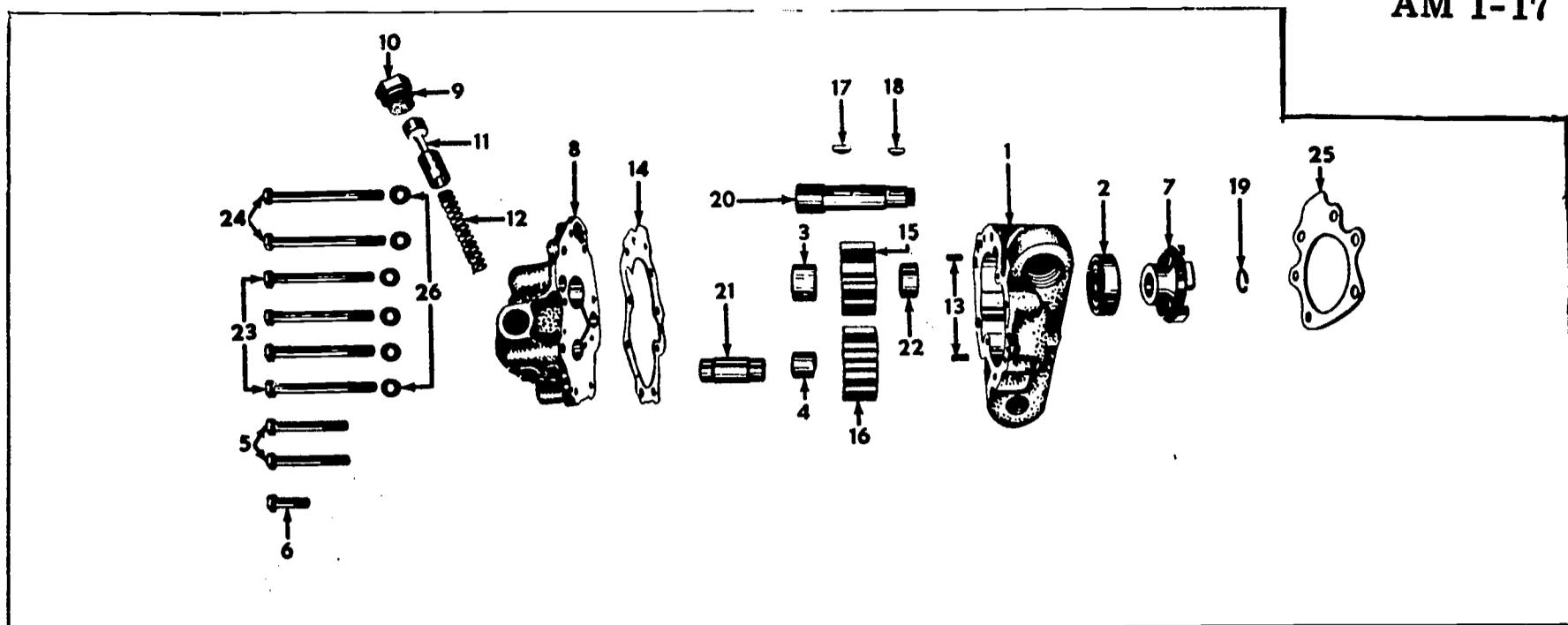

Fig. 4 Lubricating oil flow VT12-700.

Oil is drawn into the pump through an external oil line connected to the oil pan, see Figure 4. A screen in the pan filters the oil so that sludge and other foreign objects cannot enter the system.

Oil flows from the gear type pump, Figure 5, to the lubricating oil cooler to the oil filter(s), Figure 6, then to the front of the engine block where it is directed to the oil header.

OIL FILTERS - Various types of lubricating oil filters are used on



- | | |
|--------------------------------|-----------------------------------|
| 1. Pump Body | 14. Gasket |
| 2. Ball Bearing | 15. Drive Gear |
| 3. Needle Bearing | 16. Idler or Driven Gear |
| 4. Needle Bearing | 17. Woodruff Key |
| 5. Body-to-cover Capscrew | 18. Woodruff Key |
| 6. Body-to-cover Capscrew | 19. Snaprings |
| 7. Drive Coupling | 20. Drive Shaft |
| 8. Pump Cover | 21. Idler or Driven Shaft |
| 9. Cap Gasket | 22. Ball Bearing Spacer |
| 10. Plug | 23. Pump Mounting Capscrews short |
| 11. Pressure Regulator Plunger | 24. Pump Mounting Capscrews long |
| 12. Spring | 25. Gasket |
| 13. Cover-to-body Dowels | 26. Lockwasher |

Fig. 5 Exploded view of V12 type oil pump.



Fig. 6 Lubricating oil filters on the V12.

different series Cummins engines. Generally, they fall into three classes: bag-type full-flow filter, screen-type full-flow filter and by-pass filters. The filter may be either bracket mounted to the block or mounted directly to the rear of the pump in a horizontal position. If the filter is bracket mounted to the block, external oil lines are used between the pump and the filter.

For additional oil filtration, a by-pass filter(s) may be installed on the engine. This is usually a finer mesh filter, but works in much the same manner as the full flow. The difference is that oil leaving this filter returns to the crankcase and does not go to the engine. NOTE: This type of filter should never be used in place of the full-flow types.

Figure 7 shows a twin by-pass filter unit mounted on a Cummins engine.

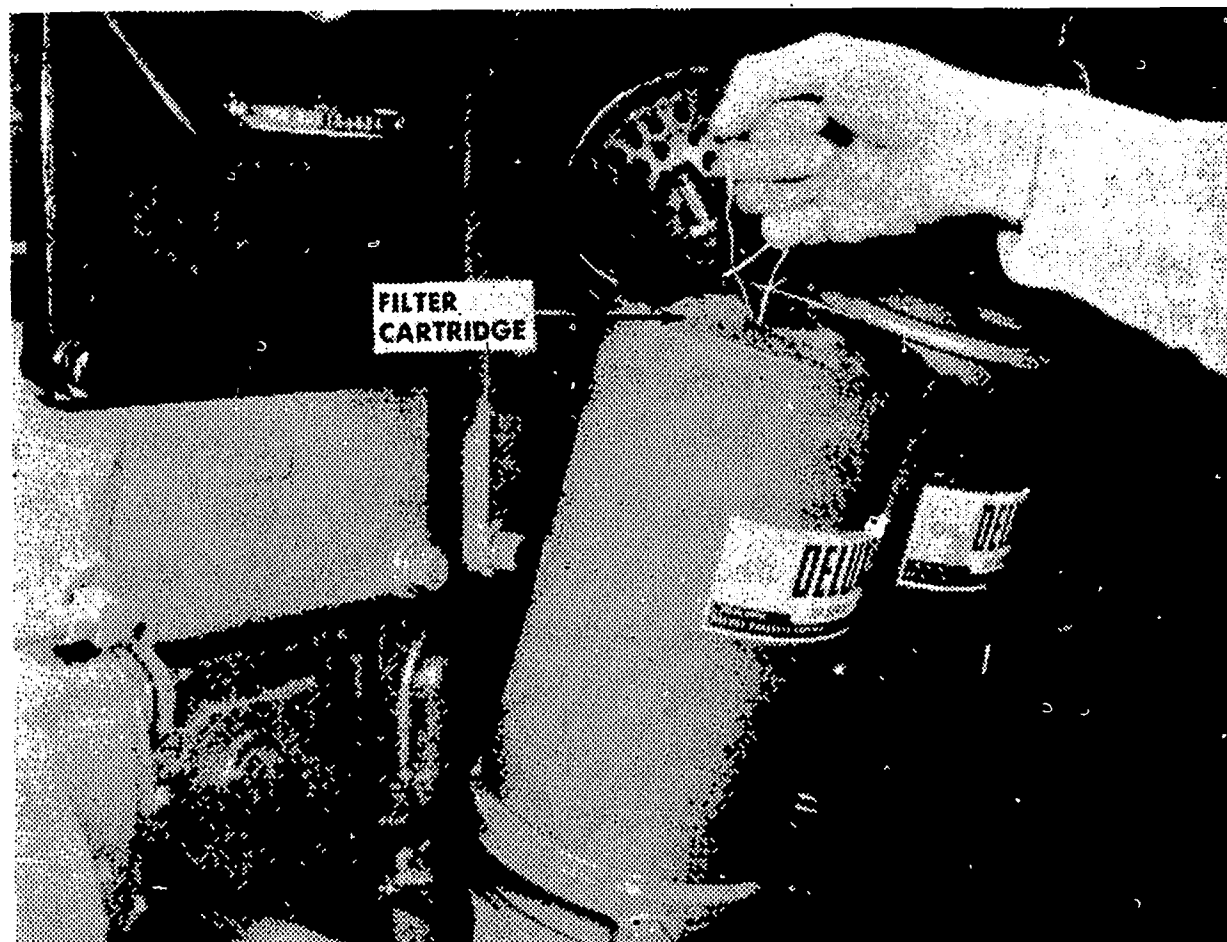

Fig. 7 Twin by-pass filter unit.

OIL HEADERS - The V-12 has two drilled oil headers running the full length of each block (one per head). These headers deliver, under pressure, oil to the moving parts of the engine, camshafts, rocker arms, valve guides, etc. Other drillings in the block direct oil to the camshaft connecting rods. The lubricating oil pressure is controlled by a pressure regulator located either in the oil pump or the filter head.

PISTON LUBRICATION - When a gear pump delivers oil through outlets of constant size (the bearing clearances), the pressure in the system increases with the speed. To prevent excessive pressures from occurring in the system, the pump is provided with a relief valve -- a spring-loaded ball or poppet valve which opens when the pressure in the system reached a certain value. This valve then by-passes sufficient oil from the delivery to the suction side of the pump (or to the sump) to keep the pressure at the bearing inlets substantially constant. Oil working through the main and crankpin bearings is thrown off by the rapidly-revolving cranks in all directions.

A certain proportion of this oil gets into the cylinders, and this oil spray is depended upon for cylinder and piston lubrication. More oil usually gets onto the cylinder walls in this way than is necessary for their proper lubrication, and the pistons therefore are provided with oil-control rings, whose function it is to scrape off excess oil from the cylinder walls and return it to the crankcase. In order that they may properly perform their function, these scraper rings must have a sharp lower edge and must exert a high unit pressure against the cylinder wall. Oil rings usually have a circumferential central groove in their outer surface, with slots at the bottom extending all the way through the ring. Any oil collecting in the groove in the ring passes through the slots into the ring groove, from which it returns to the crankcase through oil-return holes drilled through the piston skirt.

OIL COOLERS -- As previously mentioned, oil in a diesel engine is subjected to tremendous heat. This heat has to be dissipated by the engine

cooling system. On the Cummins engine, as on the GM, an oil cooler is used to cool the oil and prevent oil breakdown. When oil is too hot it cannot carry away heat; as a result the oil pressure drops. Also hot oil will not support bearing loads thereby causing high friction, worn bearings and possible engine seizure.

The method used for cleaning the V-12 oil cooler can be found in the maintenance manual. Oil coolers are normally cleaned when the entire engine must be cleaned, as in the case of contamination. They also must be cleaned when an engine rebuild is performed.

CLEANING TIPS - When disassembling and cleaning the V-12 cooler, clean the elements immediately upon removal, to prevent accumulated foreign substances from drying and hardening. A caustic solution in a hot cleaning tank is usually used for this purpose. Thorough cleaning of the element is especially important after engine failure. Any metal particles not removed will be free to travel into the system after reassembly.

SECTION D -- DETERMINING LUBRICATION SYSTEM FAILURES

INSUFFICIENT OIL SUPPLY - Whenever the lubricating system of an engine fails, the result is insufficient oil supply to the moving parts of the engine. Without proper lubrication, these parts will fail in a very short time. Insufficient oil supply is due to one or more of the following five causes:

1. Insufficient, or no, oil in the engine.
2. Blocked oil passages, clogged filters or faulty filter by-pass valve.
3. Leaks in the suction or pressure lines or in their connections.
4. Leaks in the oil pan, filter, or strainer.
5. Lubricating pump or pressure regulator not functioning properly.

RESTRICTED SUCTION LINE - Several different conditions may cause the engine to have low lubricating oil pressure. For instance, a collapsed or otherwise restricted oil suction line can limit the flow of lubricating oil to the oil pump. In Unit AM 1-15, Cooling Systems, we learned that this situation creates a condition of shock within the pump which is termed "cavitation" and that cavitation reduces the service life of the pump.

To minimize the possibility of pump cavitation, inlet lines should be kept short, and as free as possible from restrictions that could increase pressure drop within the pump. Line connections should be checked frequently to assure no leakage is occurring. Also, intake strainers in the oil pan should be checked periodically for sludge and clogging.

OIL PRESSURE REGULATOR - A faulty oil pressure regulator also can cause low lubricating oil pressure. A particle of dirt or carbon may cause a pressure regulator to stick in the "by-pass position." If this occurs, the oil will return to the crankcase directly instead of providing pressure necessary to properly lubricate the engine.

OIL CLEARANCES - Excessive oil clearances, resulting from worn or damaged main and connecting rod bearings, also will reduce lubricating oil pressure. In fact, excessive clearances anywhere along the lubricating line will lower lubricating oil pressure. This, of course, can cause progressive damage in an engine.

PROPER OIL - Use of a lubricating oil of improper grade, or failure to change the lubricating oil as often as required, also may cause improper engine lubrication. If the viscosity of the lubricating oil is too high, it will not flow freely enough to lubricate the moving parts of an engine sufficiently. An oil which is too light will prevent oil pressure from reaching normal.

Diesels perform better and experience longer life using MIL Spec 2104-A, Supplement 1 (S-1) lubricating oils. S-1 oils should always be used during the run-in period and prior to the initial oil change. After these periods S-1 oils should be continued.

SECTION E -- MAINTAINING LUBRICATION SYSTEM COMPONENTS

OIL PAN - The oil pan plays an important role in the lubrication system and should not be neglected. Some important service points to remember about the oil pan are:

1. The inside of the oil pan should be cleaned occasionally. It is important that residue is not allowed to collect in any large amount. If it is allowed to collect, it could easily work its way back into the lube system.
2. Whenever the oil pan is removed, the gasket should be replaced. Check both metal surfaces which the gasket comes in contact with, to make sure that none of the old gasket remains. And **DON'T** use Permatex or **ANY OTHER** gasket sealer.
3. Be sure to note the condition of the oil pan. Make sure that there are no dents or gouges which may cause leakage in the future when the equipment is in the field.
4. Check the pan visually for cracks. A cast iron pan can be arc welded if the cracks are of a minor nature. If cracks are in the gasket surface which mounts to the block or the flywheel housing, the pan should be replaced.
5. When checking aluminum oil pans, inspect the steel helicoil inserts used to strengthen the tapped holes. Replace any that are damaged or missing.
6. Thoroughly check the oil pan screen for damage. Replace if required.

OIL FILTERS - Much has been said about the importance of keeping the oil clean in diesel engines, in any engine for that matter. Many times the condition of a filter element will indicate to the mechanic that engine

failure is close or has occurred. For instance, if the oil filter or strainer element is packed full of dirt and sludge, it is certain that the engine is long overdue for service. If bearing metal is visible in the element, main and connecting rod bearing failure probably was in process just prior to engine rebuilding. Excessive wear indicated by the presence of metal particles in the filter element may have been noted earlier, during bearing inspection. If not, recheck the main and connecting rod bearings for any indication of early signs of failure.

NOTE: Check the maintenance manual for installation and removal procedures for various types of filters used on Cummins engines.

OIL PUMPS - As shown in Figure 5, the Cummins V-12 engine employs a positive displacement gear type oil pump equipped with a pressure regulator to relieve excessive pressure at high engine rpm.

Periodically this type of pump needs to be checked for the condition of the gears, shafts, bushings, bearings and pressure regulator valve. The following is recommended for these checks:

1. Check the gears for scoring; see if they are worn excessively, or damaged; replace if necessary.
2. Check to see if the drive shaft has been slipping within the gear; make sure the woodruff keys are properly seated; replace parts where necessary.
3. Check the idler shaft for wear; use a micrometer to gauge if it is in the limits allowed; check the maintenance manual for these limits.
4. If the pump body, bracket or cover is cracked, scored or damaged in any way, replace it.
5. Check the inside diameter of the idler gear and check it against the allowable limits in the maintenance manual.
6. Check the bearing for pitted rollers and scored races. The bearing should turn freely with little effort.

OIL COOLERS - Inspection of lubricating oil coolers consists primarily of checking the condition of the element to be certain that it is not damaged

and does not leak. Check the tubes of the element to be sure that they are welded to the end plates. If cracks or breaks are present at this location, mark the areas for soldering.

Some engine rebuild shops have devised lubricating oil cooler element testing fixtures to indicate leaks in the element. Oil cooler elements should not show leaks when placed under 20 psi air pressure. Leaks can easily be identified by air bubbles if the element is checked while it is submerged under water.

Check the diameters of the by-pass plungers in VT-12 and NVH series engine oil coolers. By-pass plungers are .06235"/0.624"OD when new, and the plunger bore in the body is 0.625"/0.626"ID. If total clearance between the plunger and bore exceeds 0.005", mark the plunger for replacement.

When inspecting the lubricating oil cooler, discard the "O" rings and gaskets. They should not be reused. Attempting to reduce costs by reusing oil rings and gaskets in oil coolers is false economy and can result in oil or water leaks and subsequent severe engine damage. Keep in mind that an "O" ring is a seal -- as in a gasket. Therefore, make it a practice to install a new "O" ring each time one is removed. When an "O" ring is compressed during installation, it takes a "set." Unless it is reinstalled in exactly the same position as when it was removed, it will no longer seal. Nobody can afford to take a chance on an old "O" ring or gasket just to save the cost of the new one. Make it a regular practice to install new "O" rings and gaskets during engine rebuilding.

OIL TUBING - Carefully inspect all of the lubricating oil tubing for cracks, Check particularly the areas near connections where the tubing has been flared. Discard cracked or damaged tubing. Dented tubing also should be discarded because it can restrict lubricating oil flow.

Check all tubing fittings and rubber packing. Make sure that the rubber packing is standard for the fittings being used and that it will seal when it is assembled with the fittings.

Inspect all flexible hose lines for defects and deterioration. Discard any hose that has become hard and brittle and cannot be bent without cracking. Remember that flexible hoses usually begin to deteriorate on the inside first. For this reason, the suction line leading from the pan to the oil pump should be changed at every engine rebuild. If the suction line were to collapse, the resulting drop in oil pressure could soon cause complete engine failure.

During inspection, don't overlook the flexible hose connections and fittings. If they are damaged or badly worn discard them.

SECTION F -- LEARNING ABOUT OIL TESTS

Although you may never be called upon to perform tests on oil to determine its condition, knowing about these tests and how they are accomplished makes you at least aware of their importance.

Some of the terms used in the following discussion have been introduced in previous units; others will be new to you.

The terms used to describe the measurement of oil are: VISCOSITY, FLASH and FIRE POINT, POUR POINT, SPECIFIC GRAVITY, CARBON RESIDUE and NEUTRALIZATION NUMBER.

VISCOSITY - The term viscosity of oil refers to the measure of its flowability at a definite temperature. Low viscosity oils, often referred to as light oils, flow freely. High viscosity oils flow slowly and are termed the heavier oils. Oils having viscosities between light and heavy are referred to as medium viscosity oils.

The viscosity of oils is determined by noting the time required for a definite quantity to pass through an orifice of standard dimensions, under known conditions of temperature and head.

The term applied to this measurement is kinematic viscosity, which is absolute viscosity divided by the specific gravity of the oil. The scientific unit of kinematic viscosity is the stoke (or the centistoke).

In order to compare the viscosities of different oils, an arbitrary system called the Saybolt scale is used. The viscosities according to this scale are determined by means of the Saybolt standard universal viscosimeter; see Figure 8.

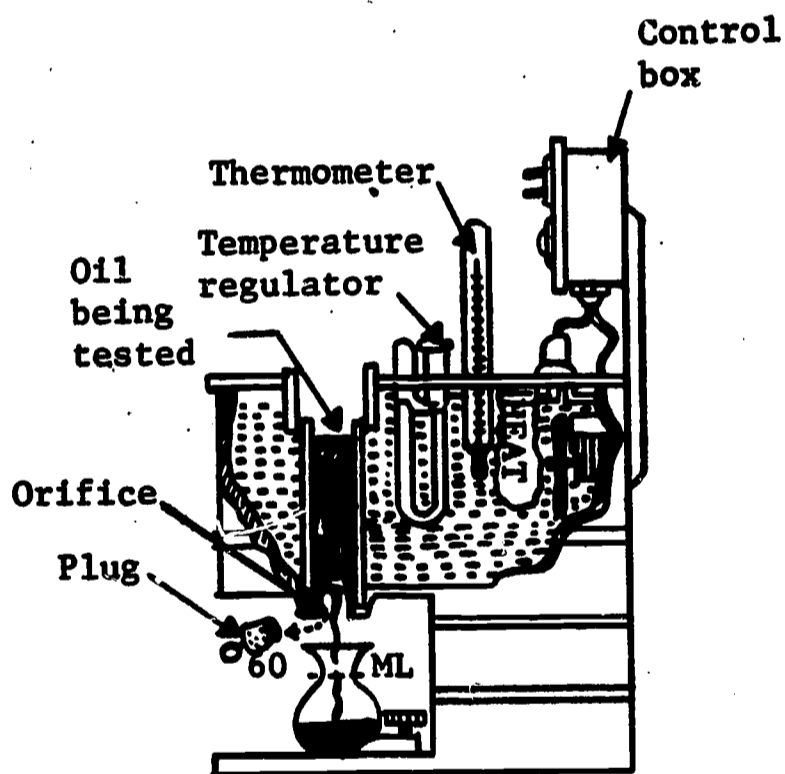

Fig. 8 Saybolt viscosimeter.

The time, in seconds, required for a definite amount of oil, usually 60 cc (cubic centimeters), to pass through the orifice while at a specified temperature, is taken as the viscosity. For example, when it is stated that a certain oil has a viscosity of 30 SUS (Saybolt Universal Seconds) at 100F,

it signifies that 30 seconds are required for 60 cc of the oil to flow through the measuring orifice of the Saybolt viscosimeter, the temperature of the oil during the test being maintained at 100 F.

SAE VS SUS VISCOSITY - We are all familiar with the term "SAE" which is widely used in the automotive industry. A comparison of SAE viscosity and SUS viscosity is shown in Table I.

<u>SAE</u> <u>Viscosity Number</u>	<u>SUS Viscosity</u> <u>at 130 F</u>	<u>SUS Viscosity</u> <u>at 210 F</u>
10	90 to 120	
20	120 to 185	
30	185 to 255	
40	255 -	to 80
50		80 to 105
60		105 to 125
70		125 to 150

Table I SAE and SUS ratings compared.

SAE 10 W oil has a viscosity equivalent to 5, 000 to 10, 000 SUS at 0 degrees F.
20 W oil has a viscosity of 10, 000 to 40,000 SUS at 0 degrees F.

The SAE designation for viscosity of oil is not used where critical viscosities are important, because of the allowable wide range of viscosity as compared to SUS designations.

VISCOSITY INDEX - The viscosity of oil changes as the temperature changes. The measure of this change is termed Viscosity Index or VI. VI is a very important consideration in selecting oil for hydraulic systems, due to the wide range of temperatures incurred during the course of operation. Of course, the wider apart the temperature range spreads, the more critical VI becomes.

FLASH AND FIRE POINT - It is very important that the oil used for lubrication shall not catch fire when exposed to heat. To make a test for this quality, a small sample is placed in a 2 1/2 inch diameter dish (Cleveland open-cup tester) and heated so that its temperature rises at the rate of 10 degrees F per minute. At each 5 degree increase in temperature, a small flame 5/32 inches in diameter is passed across the top of the cup; see Figure 9.

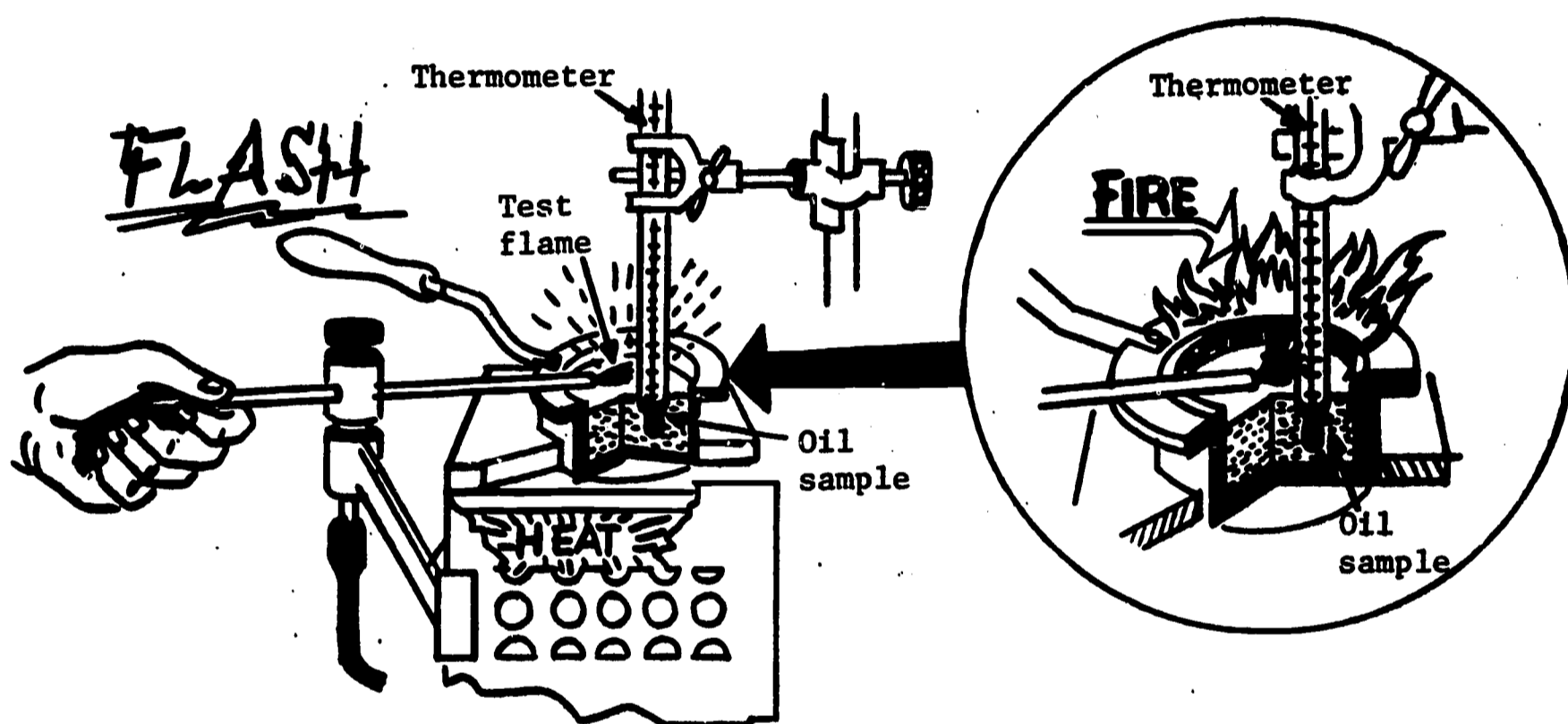

Fig. 9 Testing for flash and fire points.

The flash point is the temperature at which a distinct flash is apparent in the cup on passage of the flame. The fire point is the temperature at which the oil takes fire and continues to burn.

POUR POINT - It also is important that the oil stays fluid and does not become too thick to flow at low temperatures. The flow or pour point of an oil is the lowest temperature at which the oil will pour when chilled without disturbance, under definite prescribed conditions.

The following procedure is followed to test an oil for its fluidity at low temperatures: A sample of oil is placed in a small vessel, which is packed in a bath of ice and salt, ice and calcium chloride, or acetone and solid carbon dioxide, according to the temperature desired for the test. The sample is stirred with a thermometer while the temperature is gradually reduced. At each 5 degrees of reduction, the vessel is tilted on its side, to see if it will still run, Figure 10.

When the oil freezes, the 5 degree mark next above the temperature at which freezing was noted is recorded as the temperature of the pour point test.

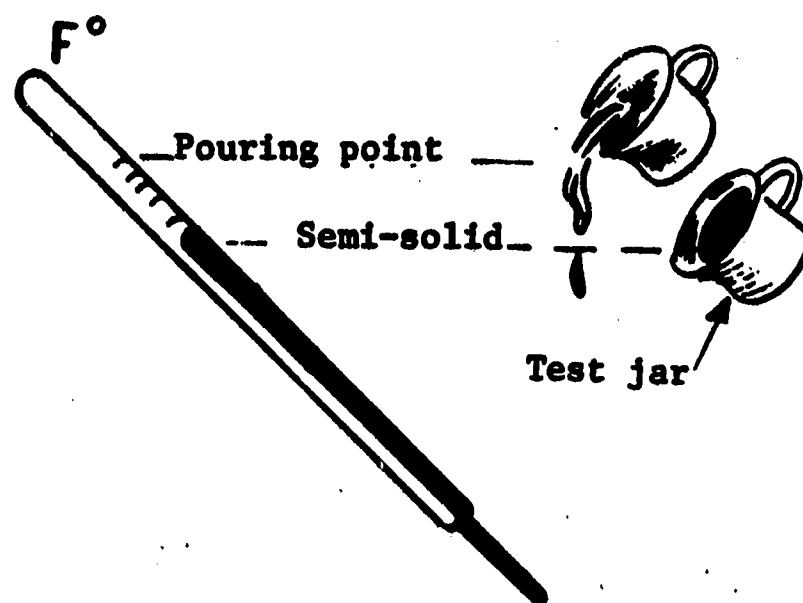
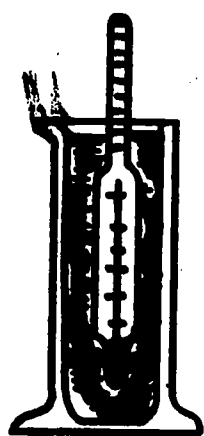
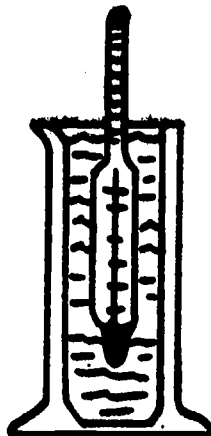

Fig. 10 Pour point test.

SPECIFIC GRAVITY - The specific gravity of an oil refers to its weight as compared to the same volume of water, which is used as a standard. The specific gravity of water is 1.0. The oil, depending upon its gravity, is either lighter or heavier than water. A typical light oil would have a specific gravity of .094, where a heavier one would be 1.2 as illustrated below.



Light oil
.094



Water
1.0

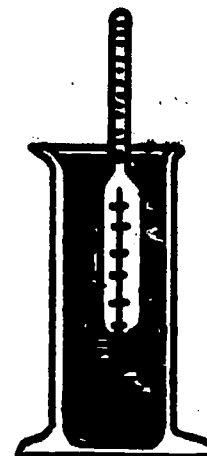

Heavy oil
1.2

CARBON RESIDUE - When an oil is subjected to high temperature, its structure tends to break down. The result of this breakdown of oil is formation of carbon or asphaltic deposits that cause such engine troubles as sticking valves, gummed piston rings, and clogged passages of the lubricating system.

The test applied to a lubricating oil for the determination of the percentage of carbon residue remaining after the oil has been subjected to a high temperature is known as the Conradson test. This test is strictly a laboratory test and should be conducted with the utmost accuracy.

Figure 11 shows how the Conradson test is performed. A sample of oil is placed in a small crucible and burned. The amount of carbon remaining is then weighed. The percentage of residue remaining after the burning is an indication of the carbon-forming tendency of the oil.

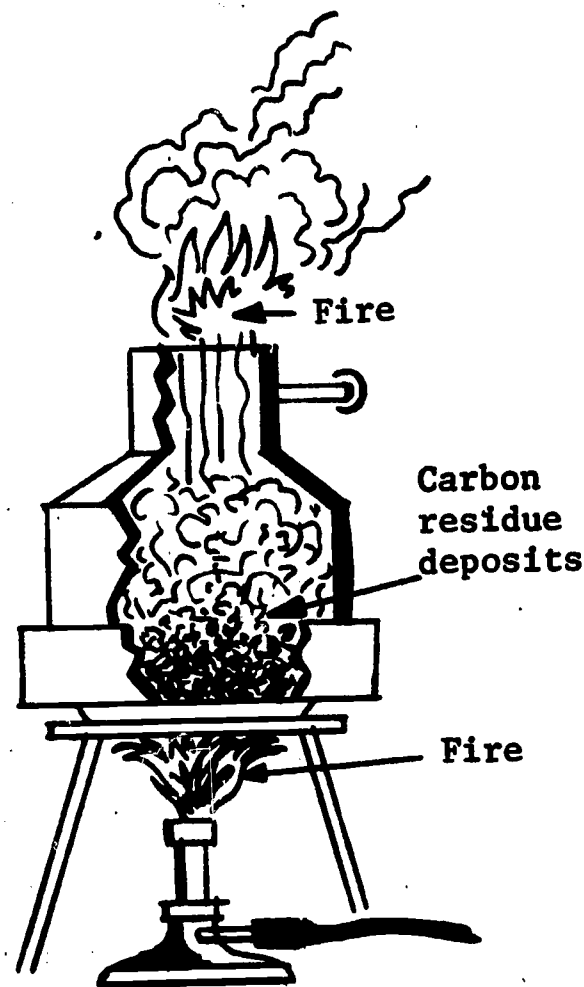

Fig. 11 Conradson test.

SECTION G -- FIELD TESTING THE OIL

LIMITED TESTING - Most large companies who maintain their own mobile equipment limit their oil tests to three or four categories of testing. The criterion for oil testing is based on application and facilities available for testing. In most instances, elaborate laboratory tests are not conducted; only the tests the company feels will satisfy its needs are performed.

At one taconite operation in Minnesota, for instance, the oil is checked for viscosity, sediment, and coolant contamination. Every 24 hours, a half pint of oil is drained from each vehicle and taken to the laboratory for the above three tests. These tests are conducted as follows:

(NOTE: All tests require the oil samples to be at a temperature of 70F. (A warming oven is used for this requirement).)

VISCOSITY CHECK - Viscosity of oil refers to the measure of its flowability at a definite temperature. Also, viscosity is determined by measuring a quantity of oil that passes through an orifice at a specified temperature. A different arrangement of testing for viscosity sometimes is used. Figure 12 shows five glass tubes mounted in a movable frame. Each glass tube contains a steel ball which is free to move the length of the tube. These balls are of a certain size and weight, and will move the length of the tube in new oils of known viscosity in a certain length of time. Oil of different viscosities (i. e. 10, 20, 30 and 40 wt.) are permanently sealed in the two sets of outer tubes. When oil is to be tested, the sample is placed in the center tube, the frame is rotated and the operator can tell by comparing how fast the balls fall what viscosity the sample is (i. e. between 20 and 30, 30 and 40, etc.). Records of oils are kept by SAE designation; #10, 20, 30, 40 etc.

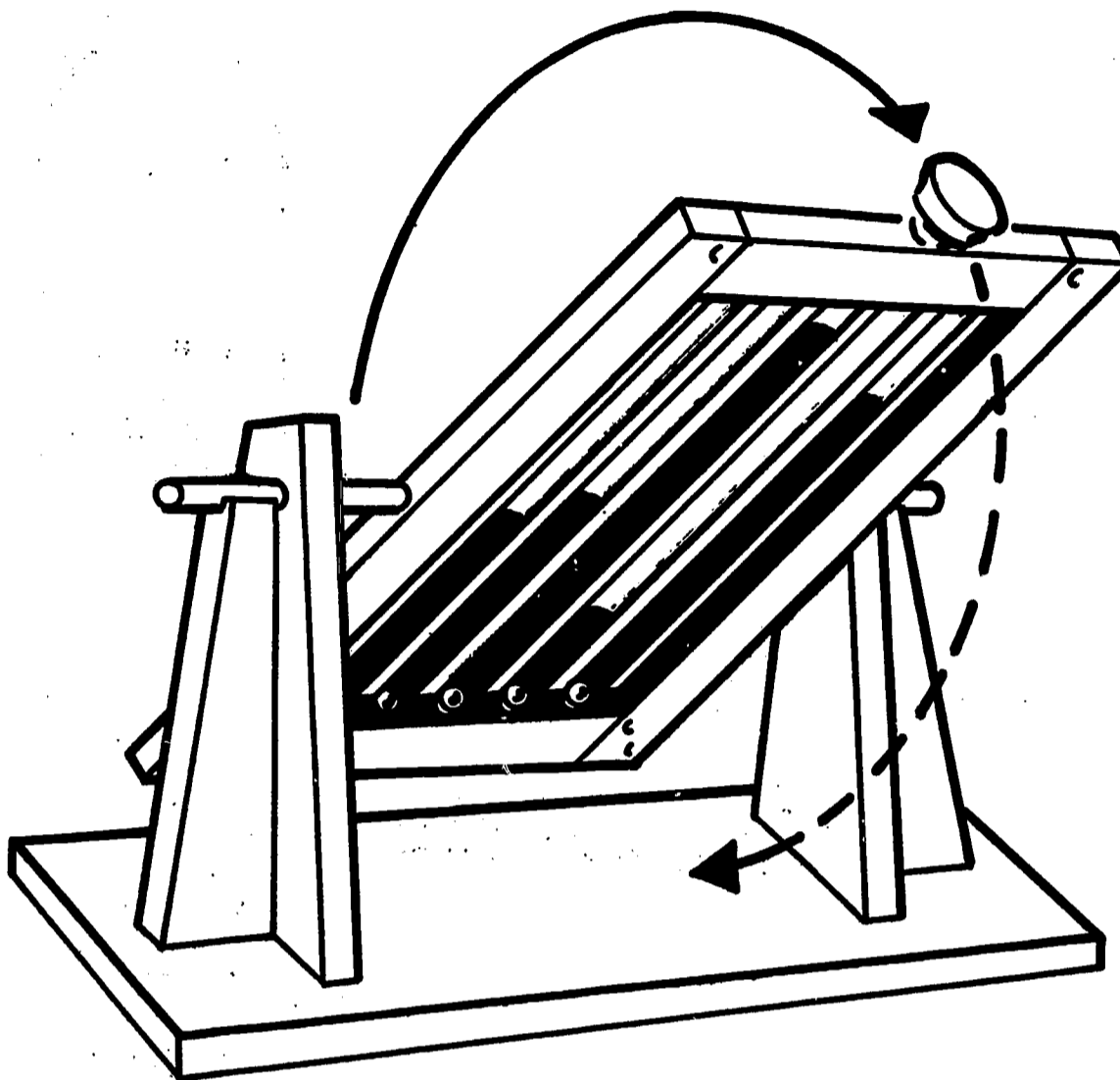

Fig. 12 Testing for oil viscosity.

SEDIMENT CHECK - The insolubles that collect in oil, as we have learned before, are the result of carbon particles or asphaltic deposits that can do a lot of engine damage if they are allowed to collect in large quantities. One test for sediments in oil is conducted as follows:

A sample of oil, 50 milliliters, to be tested, is diluted with 50ml of benzene, or toluene, and placed in a graduated centrifuge tube as in Figure 13. The sample is heated and spun at approximately 1500 rpm for 12 minutes. The sediment remaining in the bottom is read as a percentage of the total volume. The oil filters are changed when the sediment is 30%. If it reaches 60%, the oil and the filters are changed.

The sediment test is time consuming and involved, but is important. To eliminate unnecessary testing, a pre-test is conducted, which is

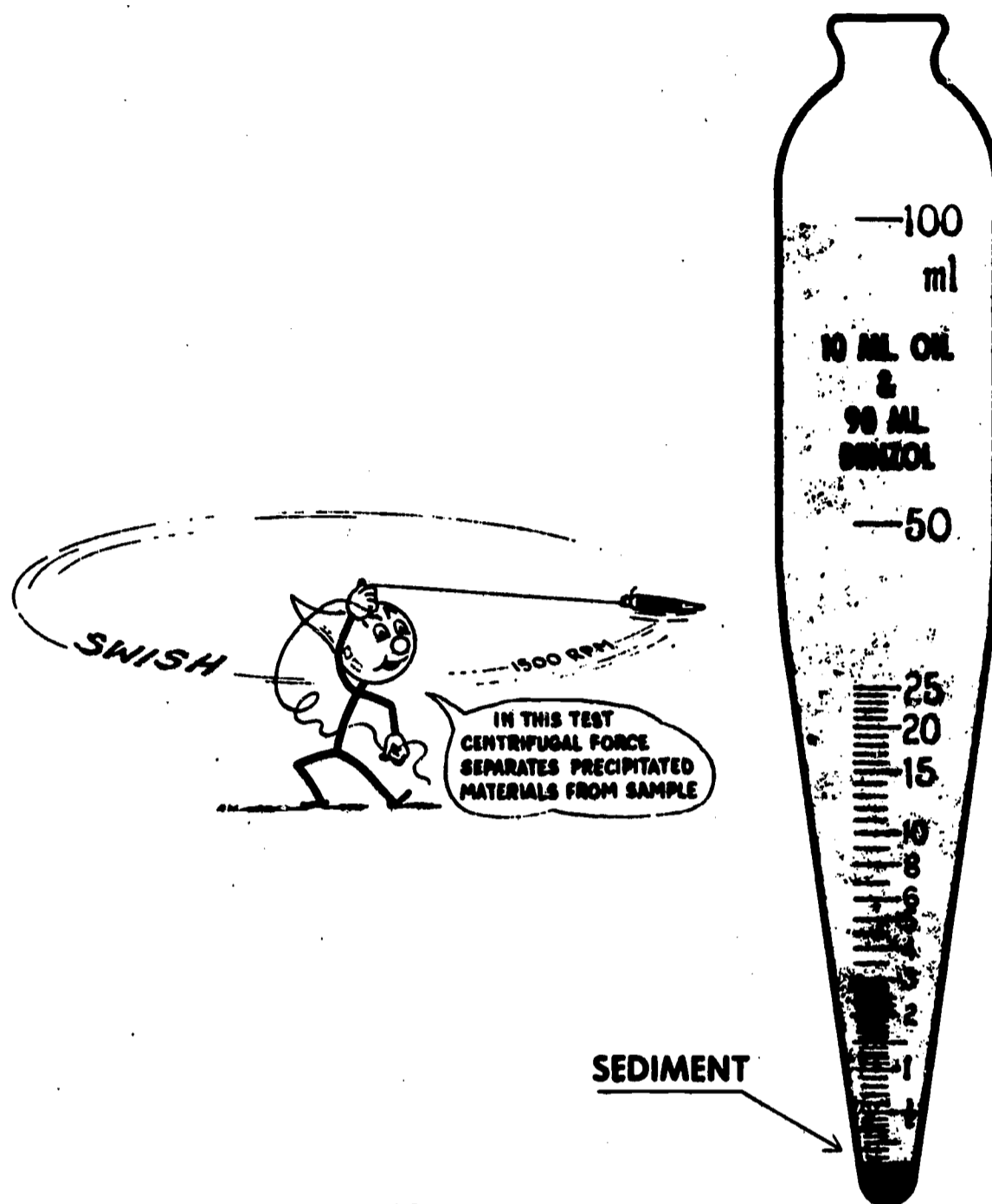

Fig. 13 Sediment test.

much faster. This test is called the ADC oil print analysis or blotter test. It consists of putting a drop of the sample oil on a blotter-like material; the pattern it makes, and the residue deposited indicate whether the sediment test is necessary.

COOLANT CONTAMINATION - Water, and ethylene glycol (anti-freeze) that gets into and mixes with engine oil can destroy an engine very quickly through lack of lubrication. Stuck piston rings, stuck hydraulic lifters, piston seizures, sludged crankcases, etc., are troubles commonly caused by permanent anti-freeze leaking into the crankcase oil.

The presence of glycol in engine oil is tested by what is called the acid-salt test. Space will not permit a detailed procedure of this test. Contact your oil test lab for this information.

These three tests - viscosity, sediment, and coolant contamination - give a rough picture of the condition of the oil. Some companies, as mentioned earlier, might feel these tests are inadequate for their purposes; others may feel they are too sophisticated. Naturally, you will follow the procedure set up by your own company.

PART II -- UNIT INSTALLATION AND REMOVAL - DRIVE LINES

SECTION A -- DRIVE LINE DESCRIPTION

The **DRIVE LINE** is a device for transmitting power. In addition to this function, the drive line must be able to accommodate any movement or misalignment of the components it connects. In almost all instances, it is impossible to align two truck components, such as a transmission and differential, so that the centerlines of their shafts lie on the same line. However, their centerlines can be made to lie along parallel lines. By making their centerlines parallel, the flanges of both components will be parallel, allowing the two components to be easily joined by universal joints and a shaft. Parallelism of the connected flanges is one of the most important factors in smooth drive line operation. A variation of only one-half of one degree can mean the difference between a smoothly operating drive line and one which is rough and noisy.

COMPONENTS - A typical drive line consists of three major parts: (1) the universal joint, which permits the drive line to pivot in any direction and to accommodate any misalignment of the components joined, (2) the propeller tube which is hollow to make a light rigid shaft that will not whip or vibrate and (3) the slip joint. See Figure 14.

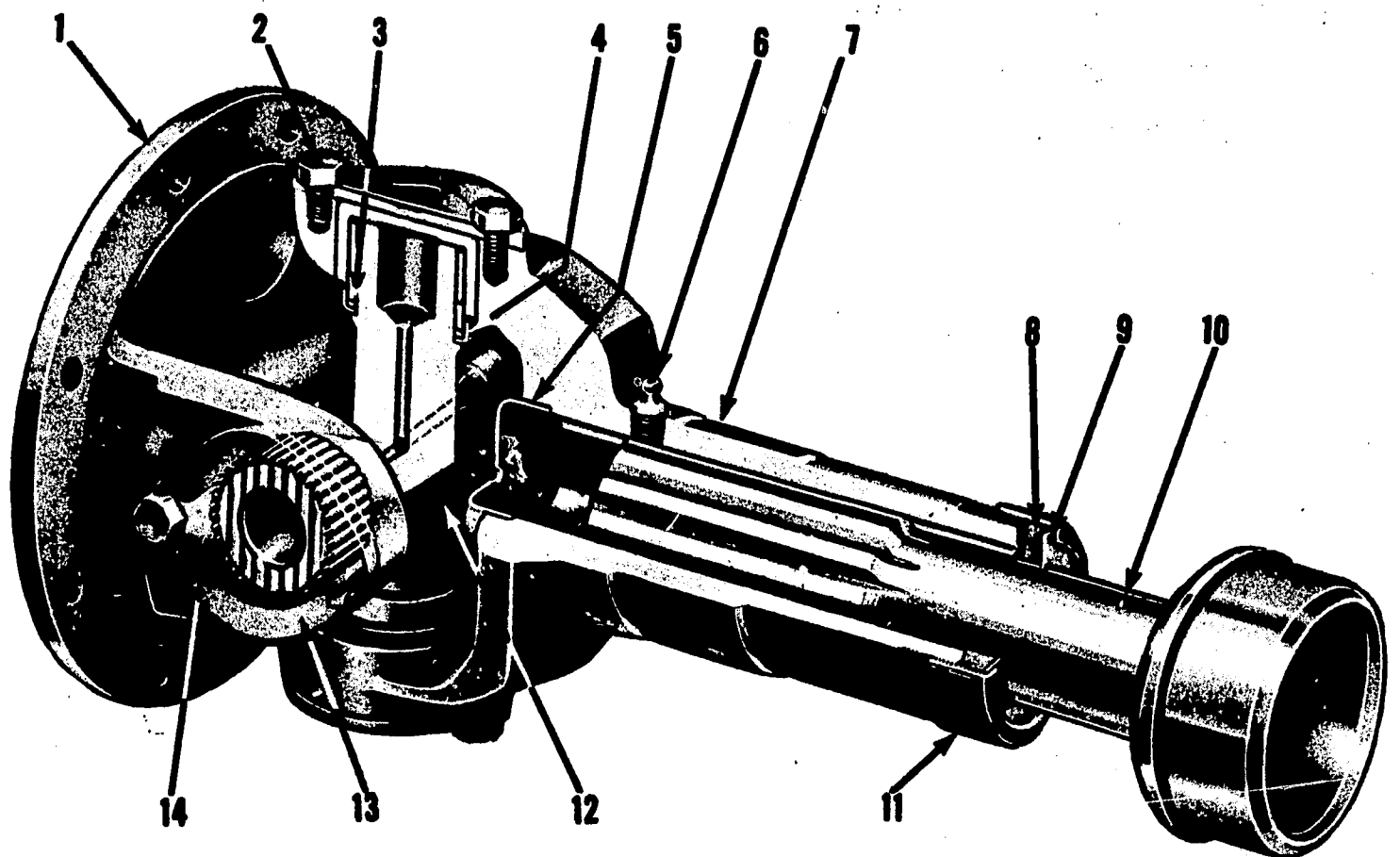

1-Flange Yoke
2-Cap Screw
3-Gasket
4-Gasket Retainer
5-Sleeve Yoke Plug

6-Grease Fitting
7-Sleeve Yoke Assembly
8-Cork Washer
9-Steel Washer

10-Slip Stub Shaft
11-Dust Cap
12-Journal Cross Assembly
13-Bearing Cap Assembly
14-Lock Strap

Fig. 14 Cutaway view of a typical drive line.

In the normal operation of a vehicle the rear axle undergoes considerable vertical movement. The drive line slip joint accommodates these variations by telescoping. It eliminates the forces of tension and compression that would be present in a drive line without a slip joint. If these forces were not absorbed by the slip joint, as in the event of slip joint seizure, the forces would be transferred to the connected components (transmission and differential) causing serious damage.

SECTION B -- REMOVAL OF DRIVE LINE

STEAM CLEANING - The first step in removing a drive line from any vehicle is to move the vehicle to the steam cleaning area. Then properly clean the area to be worked on. **CAUTION:** Use a face shield while steam cleaning, to avoid accidents and injury.

Next, move the vehicle into the shop or work area. Be sure there is enough room to do the job and that the necessary tools and equipment are available. The tools and equipment necessary to remove and install a drive line are:

1. Light floor jack.
2. Saddle for drive line.
3. Wheel blocking.
4. Floor jack with a saddle adapter, (for large drive lines).

REMOVAL - Next place wheel blocks in front and back of rear wheels so vehicle cannot move. **NOTE:** On larger drive lines use a floor jack with a saddle adapter to carry the weight of the drive line while removing the bolts.

Remove bolts fastening drive line flanges. Lower drive line. Steam clean drive line and move to rebuild area for repair or salvage.

INSTALLATION - After obtaining a new or rebuilt drive line, raise the drive line into position (using a jack and saddle) and install flange bolts. **NOTE:** Position drive line with splined joint towards transmission. On units equipped with a split end yoke, check end yoke shaft nut to be sure yoke is securely mounted on vehicle component. Place needle bearings on journal cross trunnion ends. Install drive line between end yokes and draw bearings into position between shoulders of end yokes with a "C" clamp. Fasten in place with "U" bolts, nuts, and lockwashers; see Figure 15. Be sure to align "U" joints and grease fittings; see Figure 16.

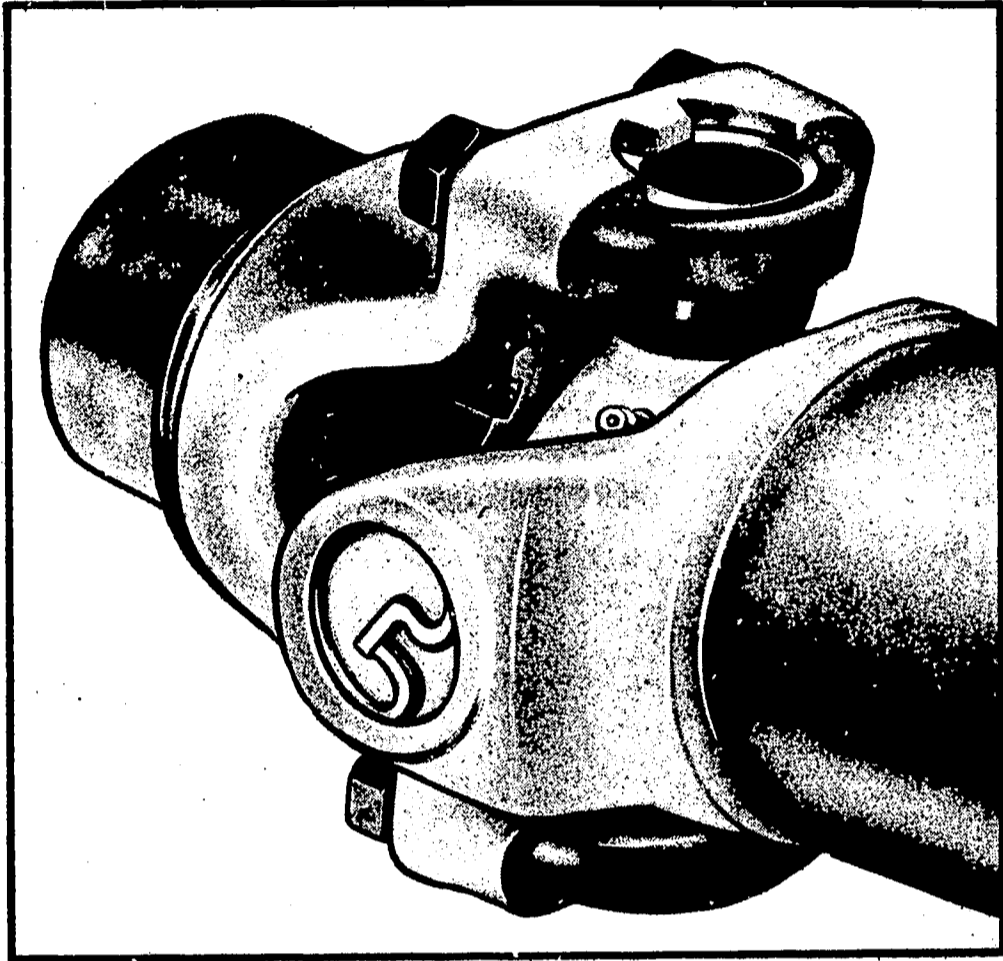

Fig. 15 End yoke "U" bolt style joint.

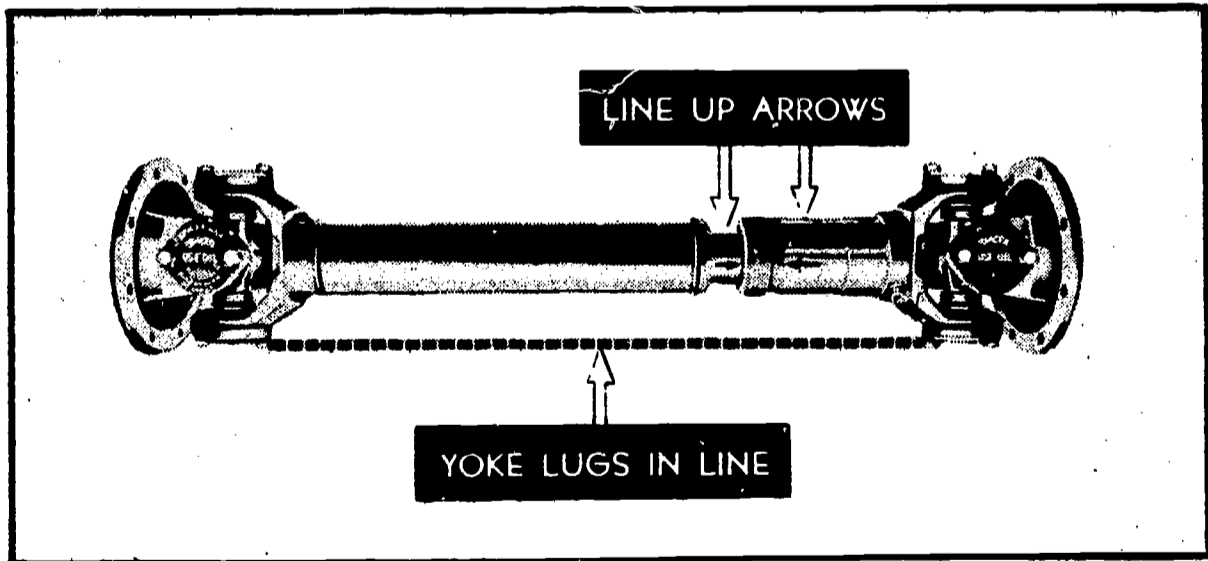

Fig. 16 Assembled drive line.

DIAL INDICATOR CHECK - After the drive line is repaired and replaced on the vehicle, a dial indicator should be set up to accurately measure drive line run-out. This should be checked at a machined surface near each universal joint and should not exceed .020". If the run-out is in excess of .020", the drive line should be removed and the drive line flanges checked for burrs, rolled edges, and any other obstructions which would keep them from seating properly. Clean and reinstall the drive line, making sure the bolts are pulled up tight. If the run-out is still more than .020" the drive line should be replaced.

Next torque all flange bolts and grease the "U" joint and the slip joint.

Remove wheel blocking, clean up the area, return the tools to their proper places, and the vehicle is ready for a road test.

ROAD TEST - In road testing the vehicle, there are two conditions to look for: vibration and noise.

Noise and vibration caused by the drive line assembly appear only at certain speeds and generally come and go as these speeds are approached and passed. When drive line noise becomes excessive, it takes the form of vibration which can be felt throughout the frame.

Should vibration or noise occur, return vehicle to shop and replace or repair drive line as required.

SECTION C -- TROUBLESHOOTING

For troubleshooting the drive line on trucks, see Table II.

TROUBLE	CAUSE	REMEDY
Noise	<p>Lack of lubricant.</p> <p>Out of balance drive line assemblies.</p> <p>Backlash due to worn trunnion or bearing.</p> <p>Excessively worn center bearing.</p>	<p>Check oil seals. Install proper grade of lubricant.</p> <p>Check to see if arrows at slip joint and grease fittings are in line.</p> <p>Clean dirt from drive line.</p> <p>Replace worn parts.</p> <p>Install new bearing, make sure frame cross member is in line.</p>
Vibration	<p>Yokes not in line.</p> <p>Drive line out of balance.</p> <p>Drive line sprung from contact with obstruction.</p> <p>Excessive run out or distorted yokes.</p> <p>Loose flange nut on transmission, transfer case or differential flange.</p>	<p>Separate drive line at center and assemble correctly.</p> <p>Replace drive line.</p> <p>Replace drive line.</p> <p>Disassemble and correct or replace damaged part.</p> <p>Check splines, if worn replace drive line, tighten nut.</p>

Table II Drive line troubleshooting.

This has been a very brief discussion on the installation and removal of truck drive lines. More about this subject will be covered later.

DIDACTOR PLATES FOR AM 1-17D

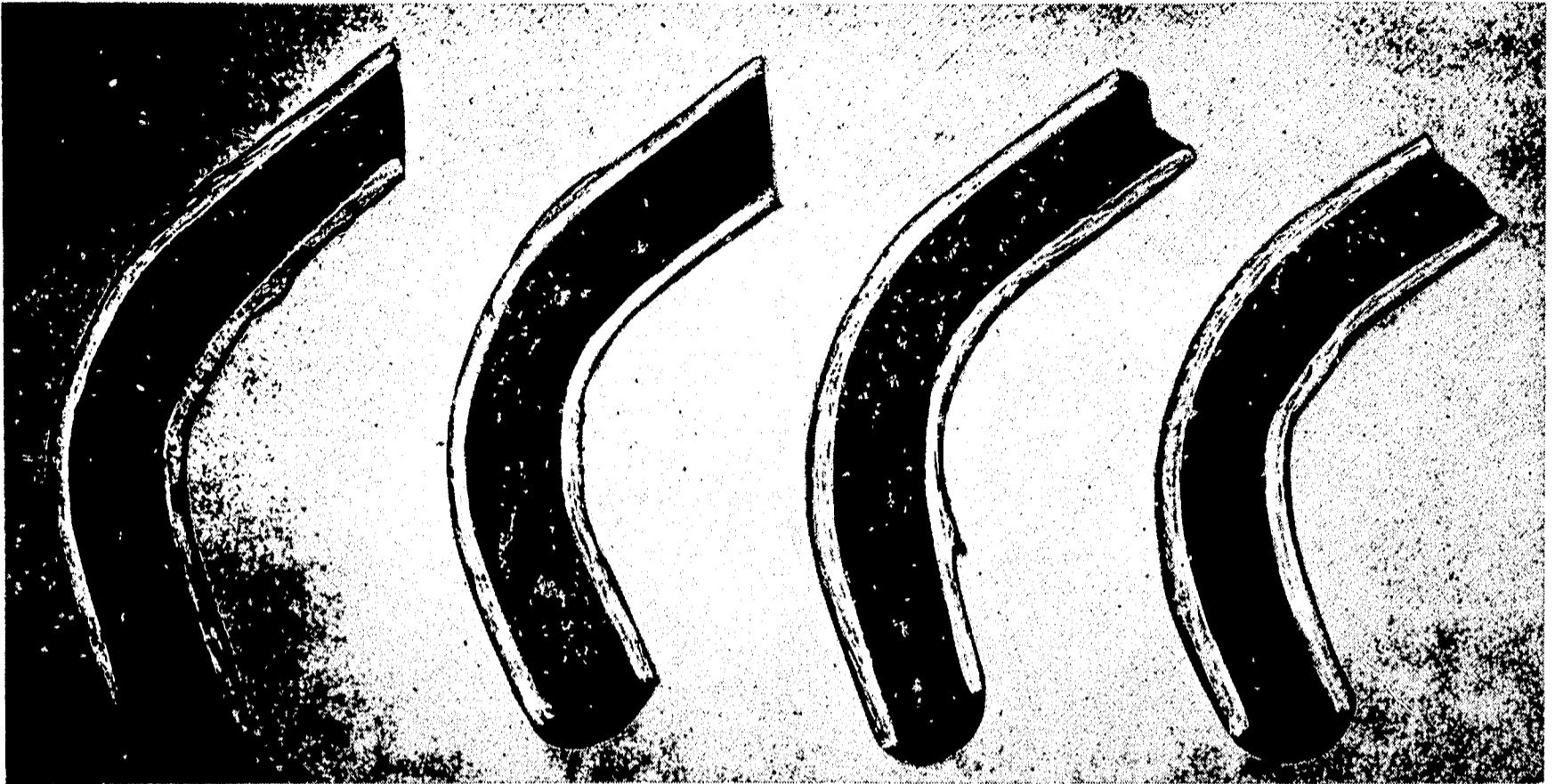
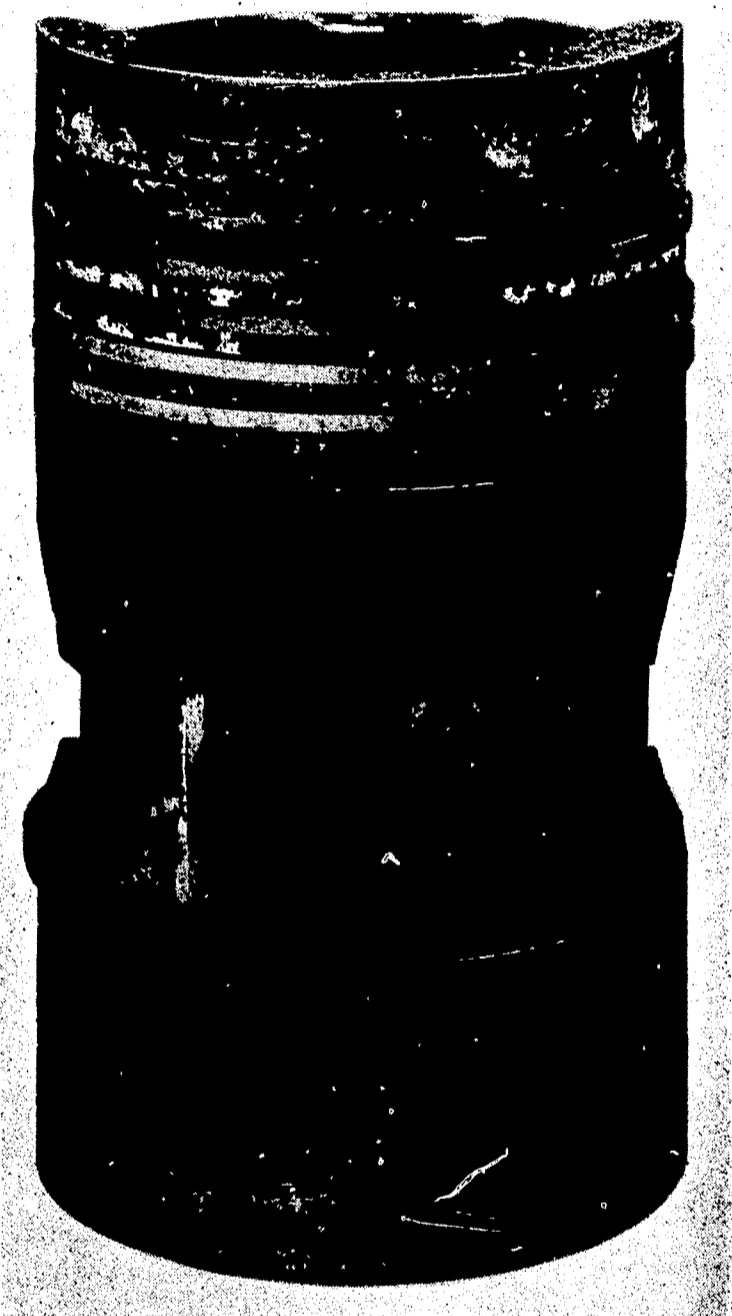

Plate I Half sections of an oil line that have become plugged with the coffee ground type of deposit.



Plate II Valve face and stem covered by heavy deposit.



(a)



(b)

Plate III Two pistons: (a) used oil containing no additives, (b) used oil containing additives. Both have had about the same amount of time in service.

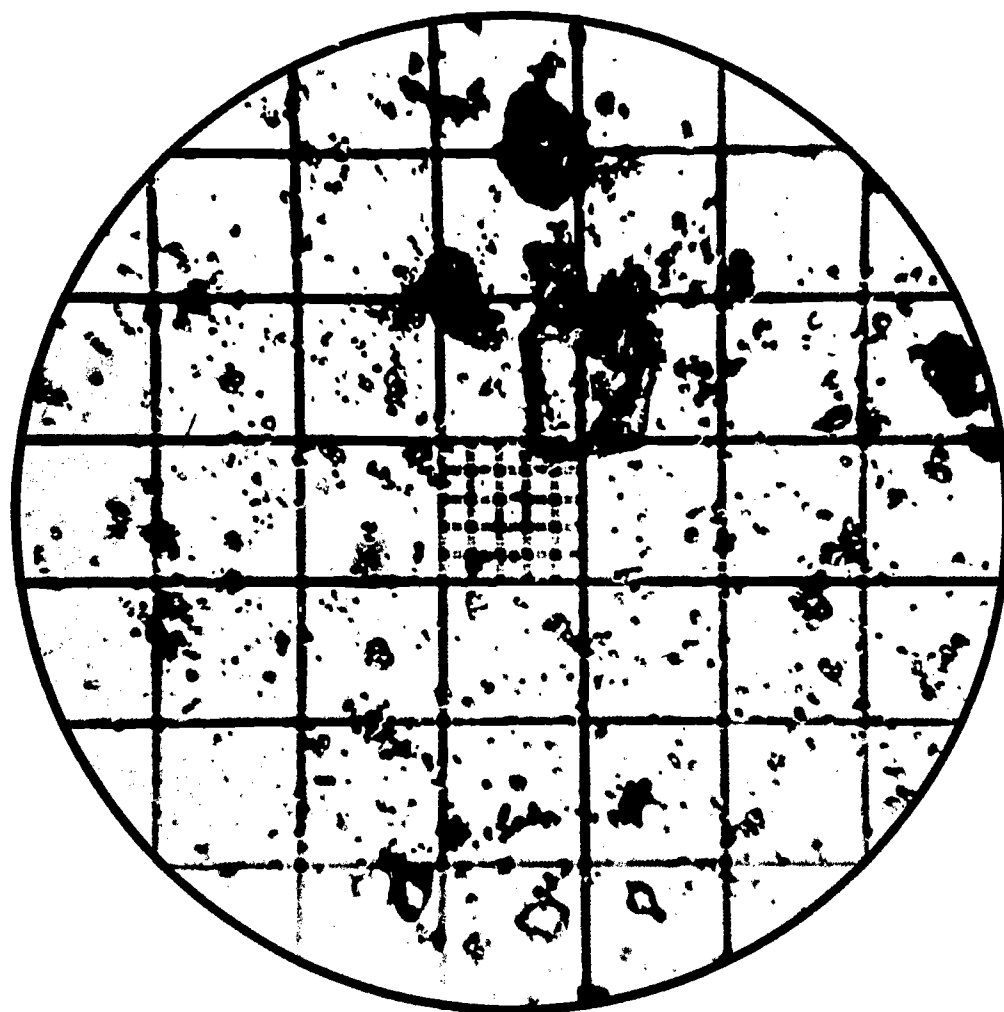

Plate IV The large grid has reference lines .001 inch apart, the smaller squares are 5 microns on the side.

AM 1-17D
6/28/66

UNDERSTANDING DIESEL ENGINE LUBRICATION SYSTEMS

Human Engineering
Institute

Minn. State Dept. of Ed.
Vocational Education

Press A /

Check to be sure that timer is OFF

In this lesson, we will review some of the lubrication problems that occur in diesel engines. Also some operating and inspection hints and troubleshooting guides concerning the lubrication system and its components will be covered, with a review of technical terms related to the system.

Press A 2

1

One of the common problems continually facing the diesel mechanic is how to keep the engine free of deposits that collect at different points, often at unpredictable intervals. The deposits usually found in the combustion chamber generally consist of silica (dust) and metallic oxides with the decomposition products of the fuel and oil serving as a binder. These deposits are commonly referred to as "sludge".

Press A 3

1

Crankcase sludge, as we know, is a thick mayonnaise-like mixture made up of used oil, water (one of the products of combustion) and finely divided particles in the form of insoluble mixtures (usually finely divided carbon in suspension in the oil).

Hence, "sludge" as it is commonly called can be found on the underside of piston heads, in the crankcase, on valve guides, connecting rods, and, as a matter of fact, anywhere that the lubricant touches, including the mud-like mixture that settles in the oil pan.

Press A 4

1

Since most of the sludge (in one form or another) is found in and around the cylinder heads and pistons, we can assume that _____

- A. too heavy an oil has been used. 5
- B. the engine has been overheated constantly. 6
- C. heat is one of the causes of sludge formation. 7

1

No. Too heavy an oil would affect proper lubrication by not being able to circulate properly. The correct answer is that oil touching heated surfaces is one cause of sludge.

Press A 7

1

No. Overheating the engine would only make sludge form faster. One of the reasons for the formation of sludge, and the answer we wanted here, is that the oil contacting heated surfaces creates these deposits. Let's see why this occurs.

Press A 8

1

OK. Extremely hot surfaces, especially around the cylinder head, tend to cause oil to crack or break down in structure. This causes the formation of carbon which readily sticks to rings and other surfaces.

Oxidation is another way oil changes in structure. The hydrocarbons in the oil combine with oxygen in the air to form organic acids. The organic acids with low boiling points (volatile acids) are usually highly corrosive. The acids with high boiling points tend to form gum and lacquers.

Press A 8

1

DIDACTOR

FILM NO. AM 1-17D
6/28/66

8

LOW TEMPERATURE SLUDGE -- Of these the emulsion type, now referred to as "winter" or low temperature sludge, is formed mostly in engines where water and other contaminants are present in the crankcase oil. We may, therefore, expect to find such formations in engines that have been operating in cold weather, subjected to low crankcase and jacket water temperatures, or subject to water contamination. These deposits can be in considerable depth on the side walls of the crankcase, the timing gear compartment, in the valve mechanisms, and the oil coolers.

Press A 5 1

9

For every gallon of fuel burned, about a gallon of water results as a combustion product. This normally passes out of the engine as vapor in the exhaust, but some of it condenses, particularly on the lower and cooler parts of the cylinder liner. This water prevents the oil from properly coating the working surfaces. Also, if hydrogen sulfide or sulphur dioxide are present (because of sulphur in the fuel), they may combine with the water and cause corrosion to the metal.

Oxidation of oil refers to _____

A. water mixing with the oil. 10

B. the formation of low temperature sludge. 10

C. the formation of organic acids. 12 1

10

No. The formation of low temperature sludge and water mixing with the oil are changes in the structure of the oil, but we talked of oxidation in another sense. Remember, we said the hydrocarbons in the oil combined with the oxygen to form organic acids and that the acids with low boiling points were (1) _____, and the acids with high boiling points tend to form (2) _____.

// A. (1) highly corrosive, (2) low temperature sludge.

// B. (1) organic acids, (2) gum and lacquers.

12 C. (1) highly corrosive, (2) gum and lacquers. 1

11

No. The answer we wanted here was (1) highly corrosive, and (2) gum and lacquers. Before going on, review the last few frames and read carefully.

Press A 7 1

12

OK. Organic acids are formed from hydrocarbons in the oil mixing with oxygen.

For every gallon of fuel burned in an engine, approximately (1) _____ gallon of water results from (2) _____.

13 A. (1) one-half; (2) the combustion process.

14 B. (1) one; (2) water condensation.

15 C. (1) one; (2) the combustion process. 1

13

No. We said one for one. One gallon of fuel burned results in one gallon of water created from the combustion process.

Press A 15 1

14

No. The one gallon of water is correct but condensation refers to the formation of water through other means than combustion. Combustion is the term we wanted for answer (2).

Press A 15 1

15

OK. Getting back to low temperature sludge, much can be done to eliminate its formation by making sure there is adequate crankcase ventilation and insisting that the engine be warmed up before a load is applied. Most equipment manufacturers prefer the engine to operate with jacket water temperatures around 180° F. In some areas of the country, higher temperatures are maintained.

HIGH TEMPERATURE SLUDGE -- High temperature sludge differs from the cold engine variety in that it is relatively free of moisture. It is composed of crankcase oil thickened with oxidation and thermal decomposition products. These products are characteristic of very heavy duty service.

Press A 17 2

XC → 16

16

You have answered one or more of the questions in this section incorrectly. Let's review what's been covered so far. Read carefully and take your time in answering.

Press A → 2

2

17

These oxidation products are known to vary over a wide range and to contain oil soluble and insoluble resins. The thickened oil will also contain varying amounts of carbon or "soot", resulting from incomplete combustion of both the fuel and oil in the combustion chamber that has been carried to the crankcase by the action of the piston rings or by the blow-by, or both.

In the crankcase oil the oxidation and thermal decomposition products may appear as finely divided solids difficult to filter out, or they may exist as small granules resembling "coffee grounds", see Plate I.

Press A 18

2

18

At one time it was assumed that these deposits were produced by particles of carbon dropping down from the underside of the hot piston heads. Now it is held by some authorities that most of these granules are formed as a result of adding fresh oil, low in solvent power, to oxidized oil, either as make-up oil or when the crankcase oil is changed. The addition of the fresh oil to the used oil (or to the quantity of oil that nearly always remains in the engine after draining) is said to curdle the used oil, forming oil-insoluble sludges.

Experience and use have shown that low temperature sludge can be held down providing there is adequate (1) and a (2) period on the engine prior to a load being applied.

- 19 A. (1) oil pressure; (2) an external heating
20 B. (1) fuel combustion; (2) warm up
21 C. (1) crankcase ventilation; (2) warm up

2

15

No. Maintaining the correct oil pressure only assures there is adequate lubrication throughout the engine, but this does not prevent low temperature sludge from forming. Read about low temperature sludge again.

Press A 15

2

20

No. Incomplete fuel combustion will cause high temperature sludge to form. Low temperature sludge can be held down providing there is adequate crankcase ventilation and a warm up period before applying a load to the engine.

Press A 21

2

21

OK. When high temperature sludges are exposed to further heating, even to normal crankcase oil temperatures, they change over into the hard granules or "coffee grounds". On occasion, they might plug the oil passages in the crankshaft that feed the bearings in pressure systems or the oil lines and oil screens. Either of these conditions will cause bearing failure.

The same thing can, of course, be said of the adhesive type sludge, if by chance they should break loose from their moorings, or be encouraged to do so through the use of oils that have a solvent effect on these deposits. Preventive measures calculated to minimize trouble from these sources will be discussed later.

Press A 22

2

22

High temperature sludge formations have no (1) deposits whereas cold temperature sludges do. Also high temperature sludge has been formed by (2) getting into the crankcase.

- 23 A. (1) carbon (2) oxygen
24 B. (1) water (2) soot
24 C. (1) oxidation (2) fuel

2

22

No. There are carbon particles in both sludges and, of course, oxygen is always in the crankcase because of ventilation. The answer we wanted is water and soot.

Press A 25

2

24
No. Both types of sludge have oxidation deposits but water is present only in the low temperature sludge.

High temperature sludge is formed by soot, the result of incomplete fuel combustion, getting into the crankcase through the blow-by.

Press A 25

2

25
OK. Fuel gets into the crankcase when there is incomplete combustion (insufficient air for the amount of fuel present).

When the blow-by is critical, it a good chance that

- A. the cylinder is being overfueled. 26
- B. there is an incomplete combustion problem. 27
- C. a piston is burned. 28

2

26

True. we said previously that when an overfueled problem was present in the cylinder, there would be some fuel slipping past the rings. However, when large quantities of fuel are bypassing the rings and the blow-by is critical, it is a good chance the piston is burned.

Press A 28

2

27
No. Incomplete combustion would not cause a serious condition of blow-by if the rings were in good shape. There would be some fuel by-passing the rings but not to an excess as the question implied. The answer we wanted is that the piston is burned when excessive blow-by occurs.

Press A 28

2

28

OK. Excessive blow-by indicates the piston is burned. Another cause of blow-by is "frozen rings" in ring bands.

In recent years it was determined that sludge, finely divided solids, sometimes called "coffee grounds", which are difficult to filter out may be caused by _____

- A. using wrong grade of oil for weather conditions. 29
- B. adding fresh oil to dirty oil. 31
- C. gasket blow-by or leakage. 30

2

29
No. If the engine has been filled with the wrong grade of oil for the weather conditions, chances are there would be a low lubricating oil pressure. The answer we want is that adding fresh oil to dirty oil would probably increase the sludge in the engine.

Press A 31

2

30

No. Gasket blow-by or leakage would not cause additional formation of sludge. This condition indicates that either the engine has broken or worn piston rings, that the engine needs an overhaul, or that the liners or pistons are scored. Try this question again.

Press A 28

2

31
OK. It has been determined in recent years that possibly the addition of fresh oil to dirty oil may increase the formation of additional sludge through oxidation.

In summary, high temperature sludge contains large amounts of tacky material consisting of resins and other decomposition products from the fuel and the oil, and is relatively free of water.

Low temperature sludge, on the other hand, contains acidulated water, carbon, oil, and other decomposition products, but is relatively free of the resins.

Unburned fuel, dust, iron oxide and metallic particles are usually present in both types.

Press A 33

2

XC → 32

You have answered one or more of the questions in this section incorrectly. Before moving on to new material, let's review the last few frames. Read carefully and take your time in answering the questions.

Press A → 15

2

32

FUEL SOOT -- While it is true that the chemical processes involved in the production of sludge are not entirely clear, we do know that finely divided carbon or soot (one of the products of combustion) plays an important part in many of them. Some of this soot reaches the crankcase either as blow-by or by the oil film on the cylinder walls, which is transferred into the crankcase by the action of the piston and rings.

Press A 34

3

33

It is estimated that the amount of soot reaching the crankcase of a diesel engine in normal operation is from five to more than eight times greater than that reaching the crankcase of a gasoline engine. A smoky exhaust, whether it is caused by overload or subnormal jacket water temperatures, will undoubtedly accentuate this difference. If at the same time the fuel injection system permits raw fuel to reach the cylinder walls, this fuel will dilute the lubrication film and promote the movement of the soot into the crankcase.

Press A 35

3

34

In diesel engine operation it is essential that suitable fuel is used, that the fuel burns cleanly, that the injection system functions properly, and that the jacket water has reached operating temperature before applying a load on the engine. Let's review.

Engineers know that fuel soot (finely divided carbon) resulting from (1) _____ gets into the crankcase either through (2) _____ or (3) _____

- 36 A. (1) poor combustion; (2) overheating; (3) flow-by.
- 37 B. (1) dirty oil; (2) overheating; (3) oil film.
- 38 C. (1) combustion; (2) blow-by; (3) oil film.

3

35

No. Not only poor combustion, but any combustion creates the fuel soot that works its way (blow-by) to the crankcase. In addition, oil film on the cylinder walls contribute to this condition by getting into the crankcase.

Press A 36

3

36

No. Fuel soot does not come from dirty oil or overheating. Soot is caused from fuel igniting and burning in the cylinder. The answer we wanted is: Fuel soot resulting from (1) combustion gets into the crankcase either through (2) blow-by or (3) oil film.

Press A 38

3

37

OK. The reason so much more fuel soot reaches the crankcase in a diesel engine vs. a gasoline engine is that

- A. the diesel combustion process is much hotter than gasoline. 39
- B. the fuel is heavier in a diesel. 40
- C. the diesel combustion process is much more dependent on a proper fuel-to-air ratio. 41

3

True, the combustion process is much hotter in a diesel engine, but the reason we wanted is that the diesel combustion process is much more dependent on a proper fuel-to-air ratio.

Press A 41

3

39

40

Not quite. The diesel fuel being heavier than gasoline is not the answer we wanted. It's the fact the diesel combustion process is much more dependent on a proper fuel-to-air ratio.

Press A 41

3

OK. Because the diesel combustion process is more dependent on a proper fuel-to-air ratio is the reason more soot accumulates in the crankcase. 41

Now let's talk about piston ring sticking.

Engine temperature levels increase with every increase in power output. In high speed diesel engines, operating under conditions that produce high ring zone temperatures, the piston ring grooves may become clogged with carbon to an extent sufficient to prevent the piston rings from functioning.

The net results of this clogging are excessive blow-by of the hot gases past the piston, the overheating of the latter, loss of compression and power, hard starting, and, eventually possible scoring of cylinders.

Press A 42

3

42

Some phases of the reaction that are responsible for these deposits on the rings and in the ring grooves are still the subject of investigation. Enough is known, however, to permit the belief that it is due in part to the presence of the previously mentioned resins that develop in either the fuel or the lubricating oil as oxidation by-products. When these resins condense on a hot surface, like the ring zone, they give rise to deposits, the most important of which are those which form the cementing material that finally causes ring sticking.

Press A 43

3

The thickness of an oil film between the faces of the piston rings and cylinder wall on its way to and from the combustion chamber and crankcase is not very great. However, if the oil film is loaded up with dust, resinous material, carbon, and other residual products from the combustion chamber, or thickened oil from the crankcase, its progress is slowed up. This increases the time interval during which the oil film is in contact with the heated ring belt portion of the piston. 43

Heated-air, either in the form of "blow-by" during the compression stroke or by its contact on the oil film on the cylinder walls, serves to accelerate the decomposition of this film. In the final stages the resulting mass gets sufficiently hard or gummy to stick the rings in their grooves. It may also happen that the parts will get so hot that the oil will no longer be able to wet the rubbing surfaces and seizure or scuffing will occur.

Press A 44

3

44

Although a lot has to be learned about what happens inside an engine, the experts feel positive that ring sticking is caused by _____

- A. excessive engine rpm and high temperatures. 45
- B. blow-by, dirt, and oxidized oil. 47
- C. the piston walls and liners being scored. 46

3

No. We know there is a high temperature around the ring zone, and that high rpm makes the ring zone become even hotter as it increases. The reason there is ring sticking, in many instances, is due to combustion gases (blow-by) carrying dust and other particles of dirt past the ring zone where the thin film of oil picks it up. This situation causes the oil to become dirt laden. And remember, we also said heat oxidizes the oil. 45

Press A 47

3

46

No. The rings sticking in a piston is not caused by scored liners. Actually it's the other way around. Stuck rings will cause scored liners. When rings are stuck, blow-by gases burn grooves in the liners, hence scored liners. The answer we wanted is rings stick because of blow-by, dirt, and oxidized oil.

Press A 47

3

OK. Even though the layer of oil is very thin around the ring zone, it can soon become thick and slow moving, with sticking characteristics when dust is introduced through the air induction system. 47

Frequent oil changes, good air filter maintenance, and conscientious engine maintenance and inspection all contribute toward combating the formation of ring sludge.

Press A

3

40
Another important fact to consider about ring sticking is the use of aluminum pistons. Much research has been done in this area and has resulted in the following:

Lubricants which have a tendency toward forming hard, sticky lacquers develop a lacquer film on the top surface of the piston ring. The film may not be of sufficient thickness to retard seriously the floating movement of the piston ring under normal operating conditions but when the engine is shut down lubricants with this characteristic show their most potent influence in ring seizure.

Press A

3

41
An aluminum piston drops very quickly to jacket water temperature directly after engine shut down. As soon as cooling begins, after combustion ceases, vertical contraction of the ring grooves tends to seize the lacquer film and clamp the ring in its groove. This clamping may not necessarily take place over the entire ring surface, but may be localized to limited regions only. However, even after the ring has been clamped, the radial contraction of the piston will result in the withdrawal of the clamped ring or the clamped portion of the ring from its adjacent cylinder surface and produce a gap between the ring and the cylinder liner. Continuance of satisfactory operation depends upon how quickly the ring is unclamped after the engine is started.

Press A

3

150
If the carbon is soft and not sticky, the floating action of the ring, by the alternate thrust movement of the piston, will keep breaking the carbon off the back of the groove. This permits some oil pumping and the desirable flushing action by circulation of the lubricant through the ring groove channels.

If however, the carbon is hard, dense and sticky, it will be only a question of time before the ring is trapped in its floating action and ultimately clamped on the inner edge of the ring, resulting in ring sticking.

Press A

3

50-1
Lubricants which have a tendency to form hard, sticky lacquers do most of their damage in an engine having aluminum pistons because aluminum

- A. expands and contracts more than steel. 51
- B. holds gummy substances longer than steel. 52
- C. cools off more rapidly than steel. 53

3

61
No. It is true that aluminum contracts and expands more than steel, but the reason we want here is: that it cools off more quickly. Steel retains heat longer than aluminum does.

Read about aluminum pistons again.

Press A

3

52
No. This may be true but the answer we wanted here is: that aluminum cools off and heats up more rapidly than steel. Read about aluminum pistons again to see why ring sticking is more common with aluminum pistons than with steel.

Press A

3

53
OK. Aluminum pistons cool off very rapidly after combustion stops.

VALVE AND PORT DEPOSITS -- Carbon passing out with the exhaust gases is apt to collect on the exhaust valves or in the exhaust ports, see Plate II. Aside from the valve seats, which may cause them to leak, the deposits may accumulate on the stems and in the valve guides causing them to stick or act erratically. In case of the exhaust ports (in 2-cycle engines), the deposits may reduce the size of the openings and affect the scavenging action of the power cylinders.

Press A

Press A

4

55
Intake ports, and sometimes intake valves, may be similarly affected. The operating temperatures of these parts are lower than similar parts in the exhaust system. Oxidation products are known to decompose at lower temperatures than oils themselves. Therefore, there is reason to believe that these products are largely responsible, not only for these deposits, but for oil ring plugging as well.

We know from past lessons that if exhaust valves become highly corroded and reduce the openings, we can expect excessive

- A. smoke escaping from the exhaust. 55
- B. crankcase sludge to be present. 56
- C. lube oil consumption. 57 4

57
No. Corroded exhaust valves would not cause excessive lube oil consumption.

The problem with having reduced exhaust openings would be poor combustion. The scavenging process could not be completed. When the combustion gases cannot escape from the cylinder, the fuel particles have a hard time uniting with fresh oxygen particles. This results in incomplete combustion and a black exhaust condition.

Press A 58 4

55
No. When lubricating oil is being used excessively, it is a good bet that the rings are bad and the engine needs an overhaul.

Try this question once more. Think what might happen if the air intake is reduced by a considerable amount.

Press A 58 4

61
OK. Should the ports of valves be clogged, this results in insufficient air, poor combustion, and black or gray smoke coming from the exhaust.

VARNISH deposits in the engine differ somewhat from the carbon like material we have been discussing up to this point. Varnish deposits are smooth, lustrous, highly insoluble, and resemble the varnish or lacquer which is used for painting. Varnish can exist on engine parts in either a light or heavy deposit, depending on the location of the port and its function.

Press A 62 4

56
No. Reduced openings because of exhaust valve corrosion would have little to do with crankcase sludge.

Think, if the combustion gases could not get out of the cylinder, the fuel particles could not find enough fresh oxygen particles to unite with. This would result in unburned fuel escaping from the exhaust ports, causing a black or gray smoke condition.

Press A 58 4

58
OK. A black or gray smoke exhaust will result from corroded exhaust valves and openings. The proper cylinder scavenging could not be accomplished, resulting in poor combustion and the escaping of unburned fuel.

Intake ports (two-cycle engines), and intake valves (four-cycle engines) can also become clogged, even though the temperature surrounding them is lower than the exhaust valves. Should clogging become critical in these areas, we could expect restricted air intake which would result in

- A. black or gray exhaust smoke and lack of power. 61
- B. lubrication oil being forced into cylinder. 59
- C. high exhaust back pressure. 60

60
No. High exhaust back pressure is caused by faulty exhaust piping or muffler obstruction.

When a high exhaust back pressure is present in an engine, this will cause a restricted air intake which results in incompletely burned fuel. However, here we have restricted ports and intake valves and the same condition exists: there would be black or gray smoke and lack of power.

Press A 61 4

62
Varnish deposits may be very heavy on parts not subjected to rubbing action, such as the crankcheeks of a crankshaft. It may be in a lesser amount of the unloaded sides of a piston. Or it may exist as faint transparent films on crankshaft main or connecting rod bearings, and similar surfaces.

It is believed that the heated surfaces transform the oxidation products of the fuel and the oil to another form which create these lacquer-like deposits.

Press A 63 4

DIDACTOR

FILM NO. AM 1-17D
6/28/66

67

High output diesel engines, particularly of the high speed type and generally lubricated by a wet sump pressure oiling system with limited reservoir capacity and without provision for cooling, are most likely to have these varnish formations. The theory behind this is that the oil in the reservoir is brought repeatedly and frequently in contact with friction surfaces which are subjected to high temperatures. Often the air is in a thin film and subjected to undue heating.

Properly spaced oil changes and good maintenance practices will minimize the formation of varnish in diesel engines.

Press A 64

4

64

Varnish deposits are unlike the heavy carbon deposits, in that they _____

- A. form a surface similar to a pitted bearing. 65
- B. deposit a smooth shiny-like surface. 67
- C. are always found in and around the piston area. 66

4

65

No. You are confused with corrosion and wear. We have been talking about deposits on engine parts both carbon-like and the varnish variety. Read the last few frames over and then answer this question again.

Press A 61

4

66

No. We said varnish deposits are also found around the crankshaft cheeks, bearing surfaces in addition to in the piston or high heat area. Try this question again.

Press A 64

4

67

OK. Let's take a look at what has been done to retard these formations.

HEAVY DUTY OILS -- Oils used today in off-highway equipment, and other heavy duty applications, contain additives to improve the oxidation resistance of the oil and also give it special detergent-dispersant properties. Oxidation resistance has been defined as that property which opposes chemical changes in an oil due to oxygen in the air and the action of heat.

Press A 68

4

68

Of the three additives in heavy duty oils, the first fortifies the oil against the formation of material that is injurious to engine bearings. At the same time, it resists the formation of the resins or cementforming material which, with the soot and other fine solids present, are held responsible for ring sticking. The last two properties are intended to disintegrate the sticky deposits that are formed and to disperse them in suspension throughout the oil. This prevents them from accumulating at some vital point in the oiling system and blocking circulation.

Press A 69

4

69

Thus, the floating particles (carbon, soot and other finely divided particles) can be easily removed by draining. The darkness of the oil confirms the additives are working. Plate III shows a good example of oil used with or without additives.

In addition to the additives already mentioned, heavy duty oils usually contain anti-foam properties. Anti-foam properties are very essential in high speed diesels where constant churning and rapid circulation is involved.

It is important to remember that these additives, although they assist in retarding sludge, should not be regarded as the "cure all". Good lubrication and intelligent maintenance is still the only answer for reliable performance.

Press B 70

4

70

One of the most important additives in heavy duty engine oil _____

- A. prevents the carbon, soot, and other materials from forming. 71
- B. maintains clean engine oil at all times. 71
- C. keeps the carbon, soot and other materials in suspension. 72

4

71

72

No. These undesirable by-products of combustion and oxidation still form in the engine but an oil containing good additives keeps these products in suspension until the oil is drained.

OK. Oxidation resistance has been defined as that property of an oil which opposes chemical change in the oil.

- A. True 74
- B. False 76
- C. Don't know 77

Press A 72

4

4

73

74

You have chosen the wrong answer. Let's review the last few frames and see where you missed the point. Read carefully.

OK.

The chemical change of oil in an engine is basically caused by _____

Press A 67

- A. using oils without additives. 75
- B. allowing the oil to run long periods without change. 76
- C. oxygen in the air and the action of heat. 77

4

4

75

76

No. Oils with additives do undergo a chemical change. Remember, we said these oils were not to be regarded as a "cure all". It is impossible to be completely free of chemical change in an engine where oxygen and heat are involved.

No. Chemical change in oil begins as soon as it is exposed to oxygen in the air and the action of heat.

Press A 77

Press A 77

4

4

77

78

OK. From our past units, we know that for a diesel engine to run properly, there must be a sufficient amount of crankcase pressure to _____

No. You have the wrong idea about blow-by. There is always a certain amount of blow-by from the combustion process. The extent of it depends on the rings and piston condition. The reason for crankcase pressure is to keep out as much dust as possible.

- A. prevent too much blow-by. 78
- B. keep the dust out. 80
- C. circulate the return oil. 75

Press A 80

4

4

79
No. The only way oil can be circulated in a pressurized system is through the action of the pump. The reason for crankcase pressure is to keep out as much dust as possible.

Press A 80

4

80
OK. Now that we have talked about the formation of sludge and oil contaminants, let's review the diesel engine lubrication system components that combat this condition.

OIL FILTERS - Practically all internal combustion engines are equipped with oil filters to protect the engine from damage that could result from the circulation of abrasive materials and deposit forming insolubles in the oil.

There are two general systems of oil filtration used:

1. Full flow - where all the oil is circulated through the filter on its way to the bearings, etc.
2. By-pass - where only a portion of the oil is circulated through the filter.

Press A 82

X C → 81 5

81
You have answered one or more of the questions in this last section incorrectly. Let's review the material to be sure it is understood. Read carefully and take your time in answering the questions.

Press A → 53

5

82
There are also two general types of filters used:

1. Depth type filters, such as cotton waste or clay (diatomaceous earth), which act by absorbing impurities while the oil passes through. This type of filter isn't used where additive type oil is utilized, hence they are rarely found on off-highway equipment.
2. Surface type filters, such as metal edge type or treated paper filters. This type stops the impurities on the outside of the filter material while the oil passes through.

Most surface type filters are changed by replacing a removable cartridge, and usually are changed when the oil is changed.

NOTE: Always add another quart of oil or so to account for the new filter displacement.

Press A

83

5

83
Oil filters are designed to allow enough oil to pass through and still filter out the unwanted foreign particles. The degree of filtration by a filter is measured in microns.

Microns are the measuring units used to express the degree of filtration for particles less than .001 of an inch. A micron is a millionth of a meter or .00004 of an inch. Most of us are familiar with thousandths of an inch (.001") from working with bearing clearances, etc. A thousandth of an inch is about 25 microns.

By definition a 20 micron filter is one which, when new, will stop 98% of the particles over 20 microns while operating under its designed flow conditions. See Plate IV for a typical filter grid.

Press A 84

5

84
As we have learned when studying earlier units, the full flow filter removes the _____ (1) _____ particles in the oil, while the by-pass filter removes the _____ (2) _____ particles.

- | | | |
|----------------|-------------|----|
| A. (1) larger | (2) smaller | 86 |
| B. (1) smaller | (2) larger | 85 |

5

85
No. The full flow filter is designed to remove particles of 40 microns or more, while the by-pass filter removes particles of 5 microns or more.

Press A 86

5

86
OK. The full-flow filter removes the larger particles.

We know that should the oil filter become completely clogged, there must be some way to by-pass the filter to keep the engine lubricated. This is accomplished by _____

- | | |
|----------------------------------|----|
| A. an electrical warning device. | 87 |
| B. a by-pass valve. | 85 |
| C. a by-pass filter. | 88 |

5

87

No. There is an electrical device which activates a dial in the cab when the oil pressure drops, but the cause could be conditions other than the oil filter. The oil filter itself comes equipped with a by-pass valve which opens at approximately 7 psi to allow for a condition such as this.

Press A 87

5

88

No. The by-pass filter would not help this situation. Should the full-flow filter clog up, the by-pass filter could not pass enough oil to satisfy the engine. Each filter, therefore, is equipped with a by-pass valve that opens around 7 psi, if the filter gets clogged.

Press A 87

5

89

OK. Each filter has a by-pass valve that opens around 7 psi.

A micron designation pertaining to an oil filter has to do with the _____.

- A. kind of filter material used. 89
- B. amount of oil that will flow through. 92
- C. replaceable cartridge type filter. 91

5

90

No. Micron refers to the size of the mesh in the filtering part of the filter. The finer this mesh is, the smaller will be the volume of oil that can flow through.

Press A 92

5

91

No. The fact that it's a replaceable cartridge type filter has nothing to do with the micron size. The micron size refers to the size of the mesh in the filtering part of the filter. The finer this mesh is, the smaller will be the volume of oil that can flow through.

Press A 92

5

92

OK. You have completed this lesson on general lubrication knowledge about diesel engines.

PRESS REWIND

X C → 93

5

93

You have answered one or more of the questions in this last part of the lesson incorrectly, let's review the last few frames to be sure you understand filters.

Press A → 80

5

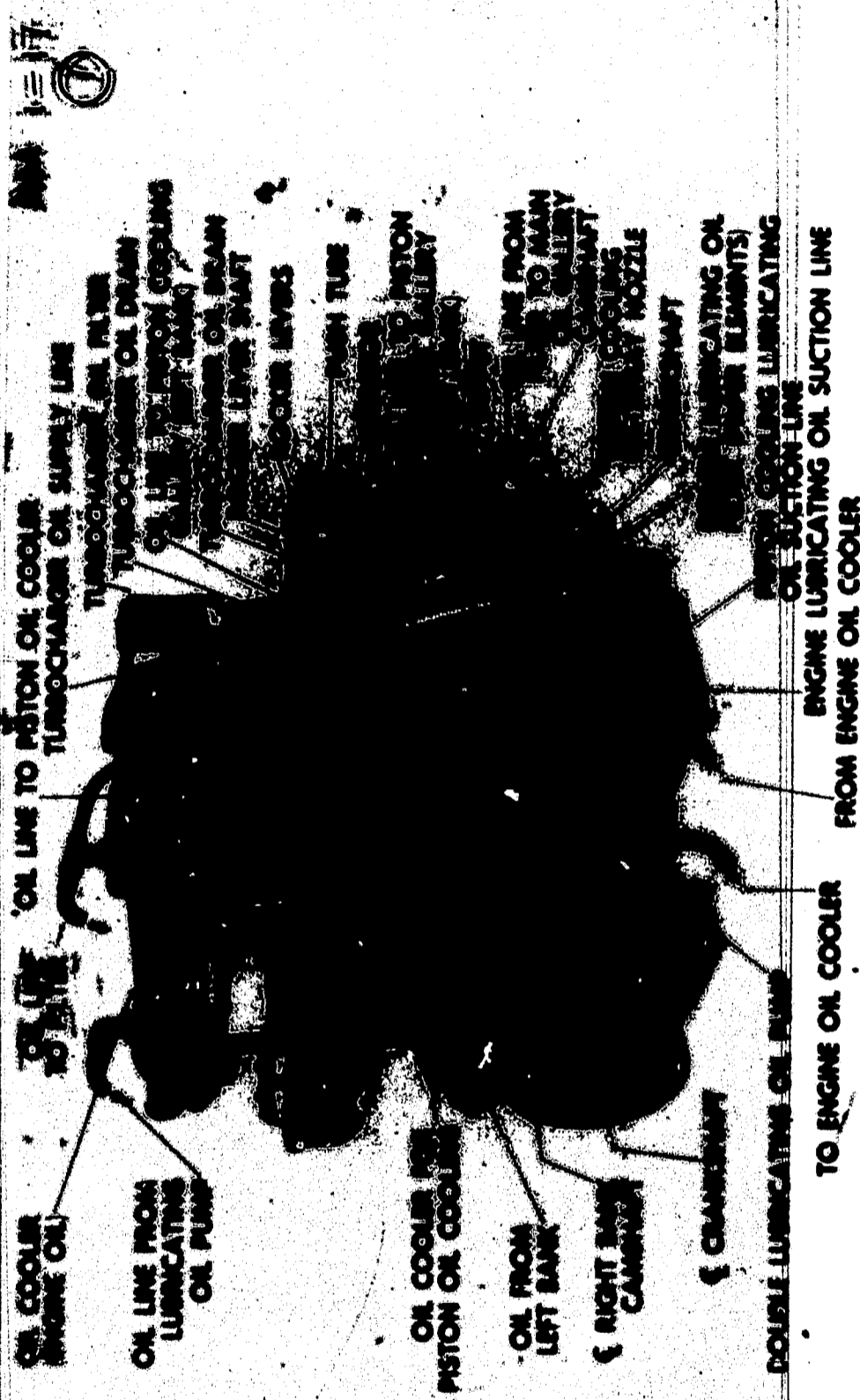

LUBRICATING OIL FLOW VT12-700

177

(Part 1/1) = Cell #2

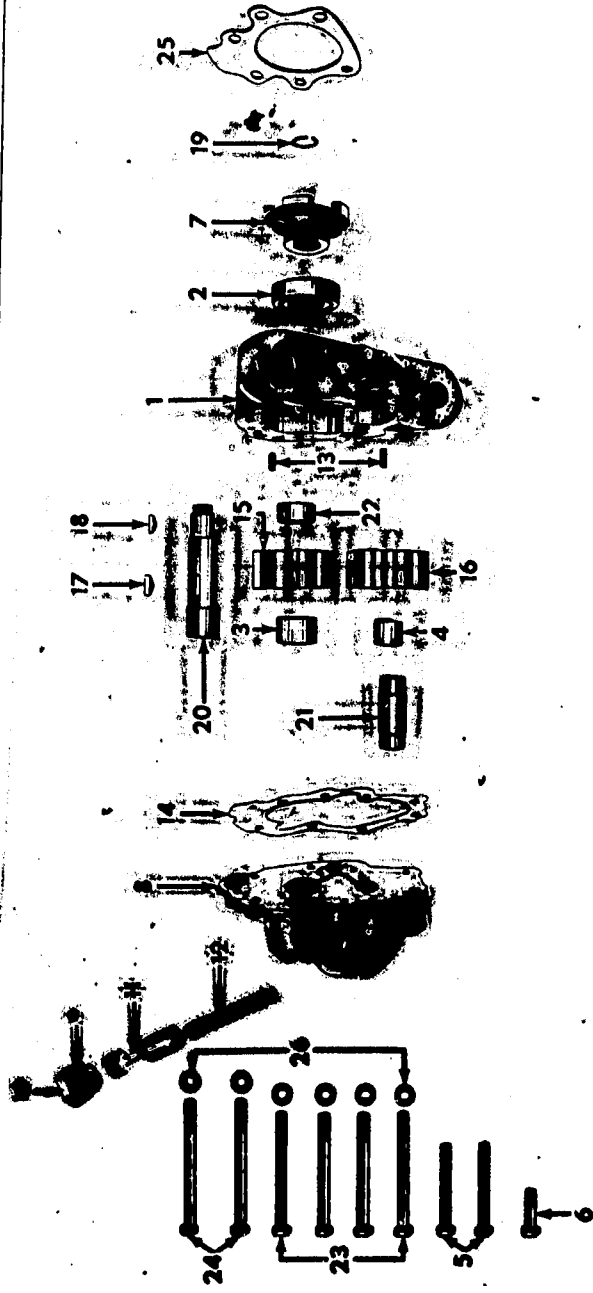

VT12 series lubricating oil pump

- | | |
|----------------------------|------------------------------------|
| 1. Pump Body | 14. Gasket |
| 2. Ball Bearing | 15. Drive Gear |
| 3. Needle Bearing | 16. Idle Gear |
| 4. Needle Bearing | 17. Wooden Key |
| 5. Body to Cover Cap Screw | 18. Wooden Key |
| 6. Body to Cover Cap Screw | 19. Shim |
| 7. Drive Coupling | 20. Drive Shaft |
| 8. Pump Cover | 21. Idle Shaft |
| 9. Cap Gasket | 22. Ball Bearing |
| 10. Pump | 23. Pump Mounting Cap screws short |
| 11. Pump Retainer Plunger | 24. Pump Mounting Cap screws long |
| 12. Spring | 25. Gasket |
| 13. Cover to Body Dowel | 26. Lockwasher |

K2

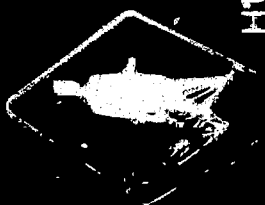

HUMAN
ENGINEERING
INSTITUTE

1000 Carnegie Ave
Columbus, Ohio 43115

(APP 1-17 - Cell # 3).

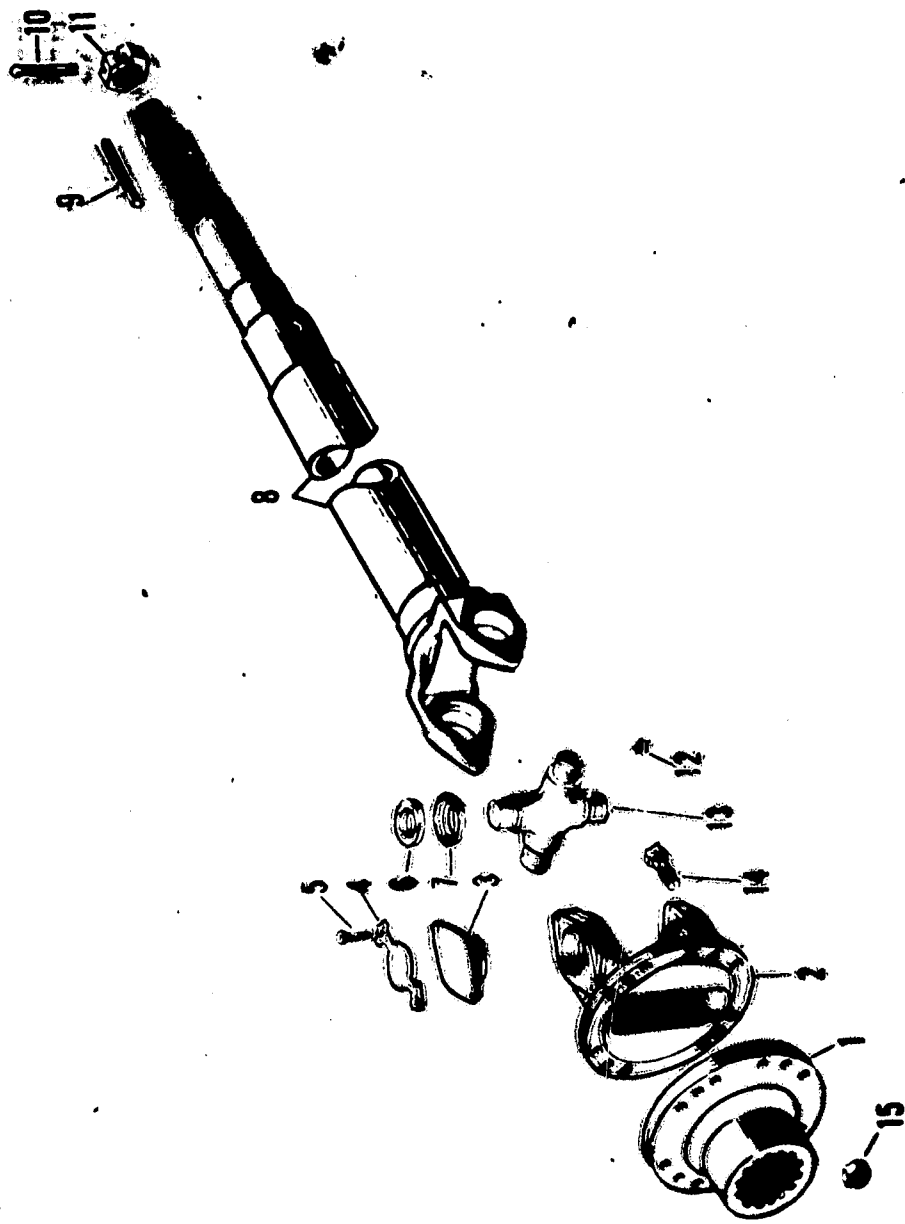

- 1-Transmission Flange
- 2-Flange Yoke
- 3-Bearing Cap Assembly
- 4-Lock Strap
- 5-Cap Screw
- 6-Gasket
- 7-Gasket Retainer
- 8-Shaft
- 9-Key
- 10-Cotter Pin
- 11-Slotted Nut
- 12-Grease Fitting
- 13-Journal Cross
- 14-Bolt
- 15-Nut

Cutaway view of a typical drive-line

(A10 1-17 - Cell #)

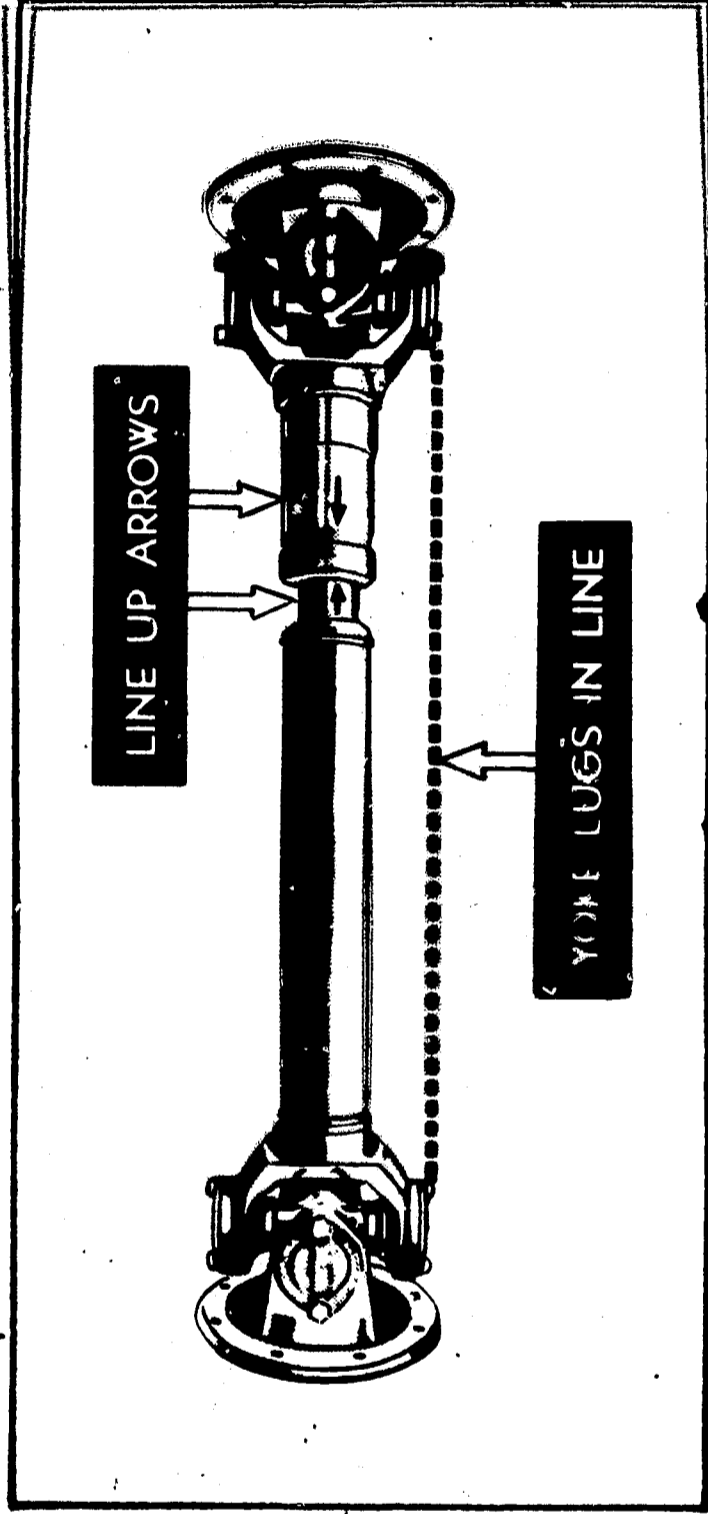

Assembled Drive Line

INSTRUCTOR'S GUIDE

I - Maintaining the Lubrication System - Cummins
Diesel Engine
Title of Unit: II - Unit Installation and Removal - Drive Lines

AM 1-17
5/24/66

FIRST: Be sure all questions have been answered that students might have on home study units.

OBJECTIVES:

1. To introduce the Cummins lubrication system as one of the most important of the four flows necessary to prolong engine life.
2. To review for the student the five functions of the lubrication system and what happens if these functions are not working.
3. To re-examine the role of each component of the lubrication system by tracing oil flow through a V12 engine.
4. To acquaint the student with tests that are performed on oil in determining its characteristics.

LEARNING AIDS suggested:

POCKET CHARTS: It is recommended that enough pocket charts be made available so each student can have one each. These charts (Bulletin No. 983564 and 983590) are excellent ready reference guides for engine performance and engine troubleshooting. Ask the local Cummins distributor for a supply.

WALL CHARTS: Bulletin No. 983481, Title: VT12-700 Lubricating Oil Flow

VUE CELLS

- AM 1-5 (11) (How oil pressure is affected)
- AM 1-167(1) (Lubricating oil flow VT12-700)
- AM 1-167(2) (VT12 Series Lubricating Oil Pump)
- AM 1-167(3) (Cutaway view of a typical Drive Line)
- AM 1-167(4) (Assembled drive line)

MODELS: Any models of lubrication components you can locate around the shop will be helpful in class. Things such as oil filters, oil pumps, oil coolers, etc.

QUESTIONS FOR DISCUSSION AND GROUP PARTICIPATION:

1. How does the cooling system aid the lubrication system?
2. What are the five functions of the lubricating system?
3. What happens if oil gets too hot in an engine?
4. What function does oil have around the pistons?
5. How is oil pressurized in an engine? Explain.
6. What is the purpose of the by-pass valve in the oil filter?
7. Why is an oil cooler necessary on a diesel engine?
8. Can a by-pass filter be used in place of the full flow filter(s)?
9. What is an oil header? Explain.
10. What is the purpose of an oil control ring on a piston?
11. What cleaning agent is recommended for cleaning oil cooler baffles?
12. What are the five most common causes for engine lubrication system failure?
13. How would a restricted oil suction line affect the oil pump?
14. What is pump cavitation?
15. What is the reason for not using gasket sealer on oil pan gaskets?
16. What is a helicoil insert for?
17. What is meant by oil viscosity? How is oil tested for viscosity?
18. Why is a driveline on a truck necessary? Explain.
19. What is a slip joint on a drive line?