

R E P O R T R E S U M E S

ED 021 078

VT 005 661

AUTOMOTIVE DIESEL MAINTENANCE 1. UNIT VII, ENGINE
TUNE-UP--DETROIT DIESEL ENGINE.

HUMAN ENGINEERING INSTITUTE, CLEVELAND, OHIO

REPORT NUMBER PTAM-1-7

PUB DATE 11 OCT 65

EDRS PRICE MF-\$0.50 HC-\$2.44 59P.

DESCRIPTORS- *STUDY GUIDES, *TEACHING GUIDES, *TRADE AND
INDUSTRIAL EDUCATION, *AUTO MECHANICS (OCCUPATION), *DIESEL
ENGINES, ADULT VOCATIONAL EDUCATION, TRANSPARENCIES,
PROGRAMED MATERIALS, INDIVIDUAL INSTRUCTION, INSTRUCTIONAL
FILMS, PROGRAMED INSTRUCTION, MOTOR VEHICLES, EQUIPMENT
MAINTENANCE,

THIS MODULE OF A 30-MODULE COURSE IS DESIGNED TO DEVELOP
AN UNDERSTANDING OF TUNE-UP PROCEDURES FOR DIESEL ENGINES.
TOPICS ARE SCHEDULING TUNE-UPS, AND TUNE-UP PROCEDURES. THE
MODULE CONSISTS OF A SELF-INSTRUCTIONAL BRANCH PROGRAMED
TRAINING FILM "ENGINE TUNE-UP--DETROIT DIESEL ENGINE" AND
OTHER MATERIALS. SEE VT 005 655 FOR FURTHER INFORMATION.
MODULES IN THIS SERIES ARE AVAILABLE AS VT 005 655 - VT 005
684. MODULES FOR "AUTOMOTIE DIESEL MAINTENANCE 2" ARE
AVAILABLE AS VT 005 685 - VT 005 709. THE 2-YEAR PROGRAM
OUTLINE FOR "AUTOMOTIVE DIESEL MAINTENANCE 1 AND 2" IS
AVAILABLE AS VT 006 006. THE TEXT MATERIAL, TRANSPARENCIES,
PROGRAMED TRAINING FILM, AND THE ELECTRONIC TUTOR MAY BE
RENTED (FOR \$1.75 PER WEEK) OR PURCHASED FROM THE HUMAN
ENGINEERING INSTITUTE, HEADQUARTERS AND DEVELOPMENT CENTER,
2341 CARNEGIE AVENUE, CLEVELAND, OHIO 44115. (HC)

STUDY AND READING MATERIALS

AUTOMOTIVE DIESEL MAINTENANCE

1

ENGINE TUNE-UP: DETROIT
DIESEL ENGINE

UNIT VII

TABLE OF CONTENTS

SECTION A

SCHEDULING TUNE-UPS

SECTION B

TUNE-UP PROCEDURES

U.S. DEPARTMENT OF HEALTH, EDUCATION & WELFARE
OFFICE OF EDUCATION

THIS DOCUMENT HAS BEEN REPRODUCED EXACTLY AS RECEIVED FROM THE PERSON OR ORGANIZATION ORIGINATING IT. POINTS OF VIEW OR OPINIONS STATED DO NOT NECESSARILY REPRESENT OFFICIAL OFFICE OF EDUCATION POSITION OR POLICY.

PTAM 1-7
10/11/65

HUMAN ENGINEERING INSTITUTE

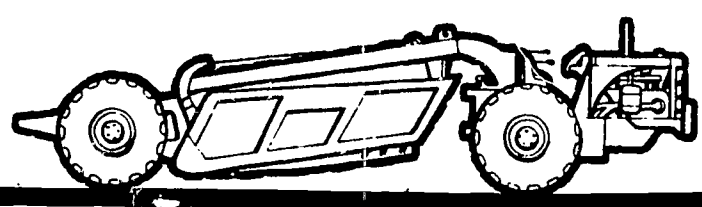
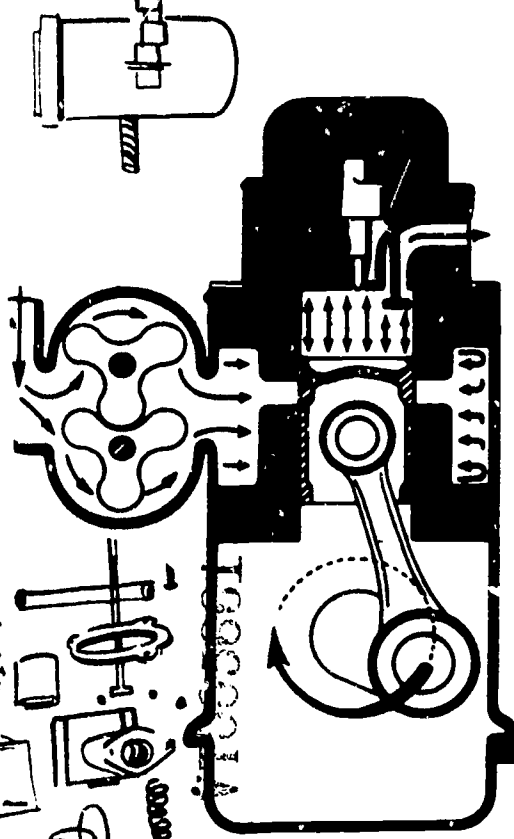
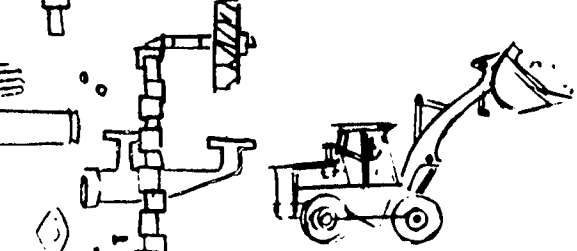
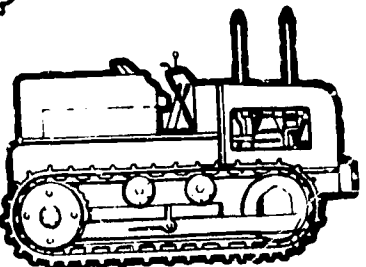
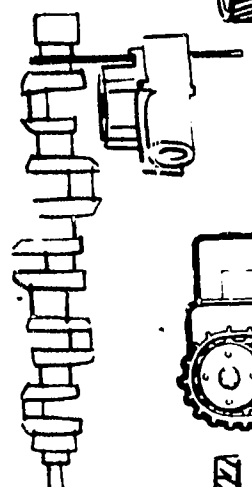
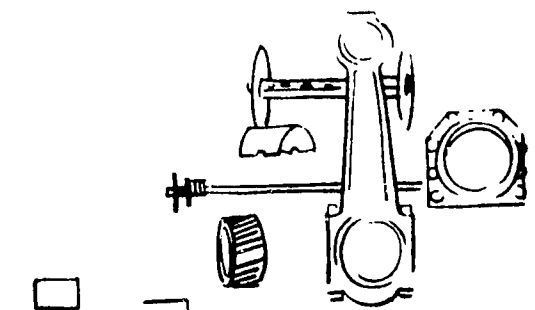
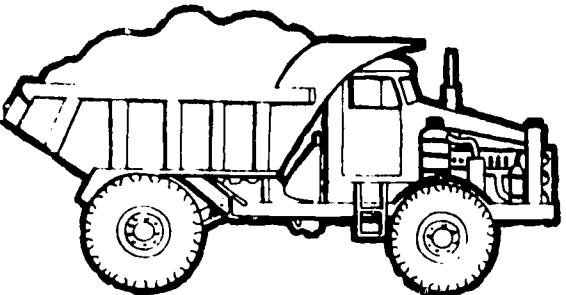
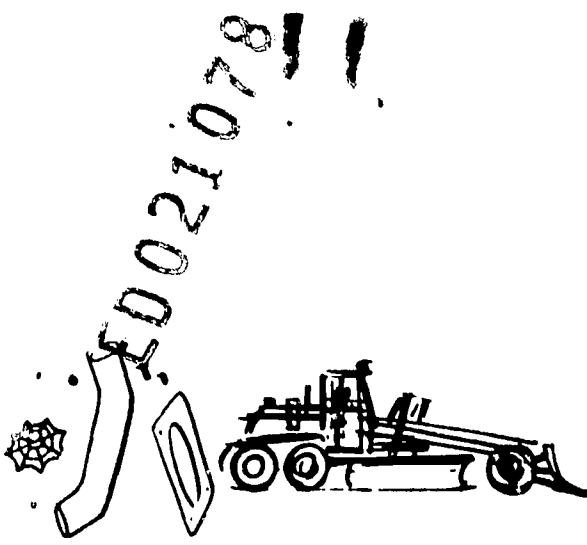

SECTION A -- SCHEDULING TUNE-UPS

In previous units we have covered the basic components of both the inline 71 and the Vee-71 series Detroit Diesel Engines. By this time we know an injector from a governor, a valve from a crankshaft, etc. We have been subjected to the four flows in the diesel: air, water, fuel, and oil. We know how the components of each flow operate and function, and how each one is dependent on the other for maximum engine efficiency and operation.

Since there are numerous combinations of engines and types of governors, (i. e. , inline with a limiting speed single or double weight; inline with variable speed; Vee with a limiting speed etc.), this unit will cover the step by step procedures for tuning an inline series with a limiting speed governor and a Vee series with a limiting speed governor. Check your maintenance manual for the difference in steps and readings necessary to tune the other combinations you may be working with.

First, it is important to know when an engine tune-up is necessary. All diesel engines, regardless of type should be tuned-up when:

1. A new engine is installed.
2. A new engine has run 100 hours, or 300 miles.
3. Performance is unsatisfactory.
4. An engine has just been overhauled.
5. The cylinder head assembly has been serviced.

All mechanical engine governors, as mentioned before, are identified by a nameplate attached to the governor housing. For instance letters D. W. L. S. identify the governor as being a double weight, limiting speed type. A single weight, variable speed would be stamped S. W. V. S.

Normally, when performing a tune-up on an engine in service, it is only necessary to check the various adjustments for a possible change in the settings. However, if the cylinder head, governor, or injectors have been replaced or overhauled, then certain preliminary adjustments are required before the engine is started.

SECTION B -- TUNE-UP PROCEDURES

The preliminary adjustments consist of the first four items in the tune-up sequence as outlined below. The procedures are the same except that the valve clearance is greater for a cold engine. (Refer to your maintenance manual for this information.)

To tune-up an engine completely, all of the adjustments, except the valve bridge adjustment on four valve cylinder heads, are made by following the tune-up sequence given below, after the engine has reached the normal operating temperature. Since the adjustments are normally made while the engine is stopped, it may be necessary to run the engine between adjustments to maintain normal operating temperature.

NOTE: The exhaust valve bridges on the four valve cylinder head are adjusted at the time the cylinder head is installed on the engine and, until wear occurs, no further adjustment is required. When wear is evident, perform a complete valve bridge adjustment.

The tune-up procedures apply to the individual engines of multiple engine units as well as to the single engine units. However, the throttle linkage of multiple engine units must be adjusted after the individual engines have been tuned-up.

It is extremely important that the following tune-up steps be followed in sequence:

Tune-up Sequence for Mechanical Governors:

1. Adjust the exhaust valve clearance.
2. Time the fuel injectors.
3. Adjust the governor gap.
4. Position the injector rack control levers.
5. Adjust the maximum no-load speed.
6. Adjust the idle speed.
7. Adjust the buffer screw.
8. Check the linkage and throttle movement.

PERFORMING STEP No. 1 -- EXHAUST VALVE CLEARANCE ADJUSTMENT. -- NOTE: unless specified the same procedure is used on the inline series as on the Vee series.

The correct exhaust valve clearance at normal engine operating temperature is important for smooth, efficient operation of the engine.

Insufficient valve clearance can result in loss of compression, misfiring cylinders, and - eventually - burned valve seats and valve seat inserts. Excessive valve clearance will result in noisy operation, especially in the low speed range.

Whenever the cylinder head is overhauled, the exhaust valves are reconditioned or replaced, or the valve operating mechanism is replaced or disturbed in any way, the valve clearance must first be adjusted to the cold setting to allow for normal expansion of the engine parts during the engine warm-up period. This will insure a valve setting that is close enough to the specified clearance to prevent damage to the valves when the engine is started.

Performing Exhaust Valve Adjustment on Engines with Two Valve Cylinder Heads -- The exhaust valve clearance is always adjusted at the push rod. **DO NOT DISTURB** the exhaust valve bridge adjusting screw.

All of the exhaust valves may be adjusted during one full revolution of the crankshaft.

When performing valve clearance adjustment on a cold engine proceed as follows:

1. Place the governor stop lever in the NO-FUEL position.
2. Rotate the crankshaft until the injector follower is fully depressed on the cylinder to be adjusted.

CAUTION: When using a wrench on the crankshaft bolt at the front of the engine, do not turn the crankshaft in a left-hand direction of rotation; this will loosen the bolt.

3. Loosen the push rod lock nut.
4. Place a .013" feeler gage, tool J9708, between the valve stem and the rocker arm (See Figure 1). Adjust the push rod to obtain a smooth "pull" on the feeler gage.
5. Remove the feeler gage. Hold the push rod with a 5/16" wrench and tighten the lock nut with a 1/2" wrench.
6. Recheck the clearance. At this time, if the adjustment is correct, the .011" feeler gage will pass freely between the valve stem and the rocker arm, but the .013" feeler gage will not pass through.
7. Check and adjust the remaining valves in the same manner, as outlined above.

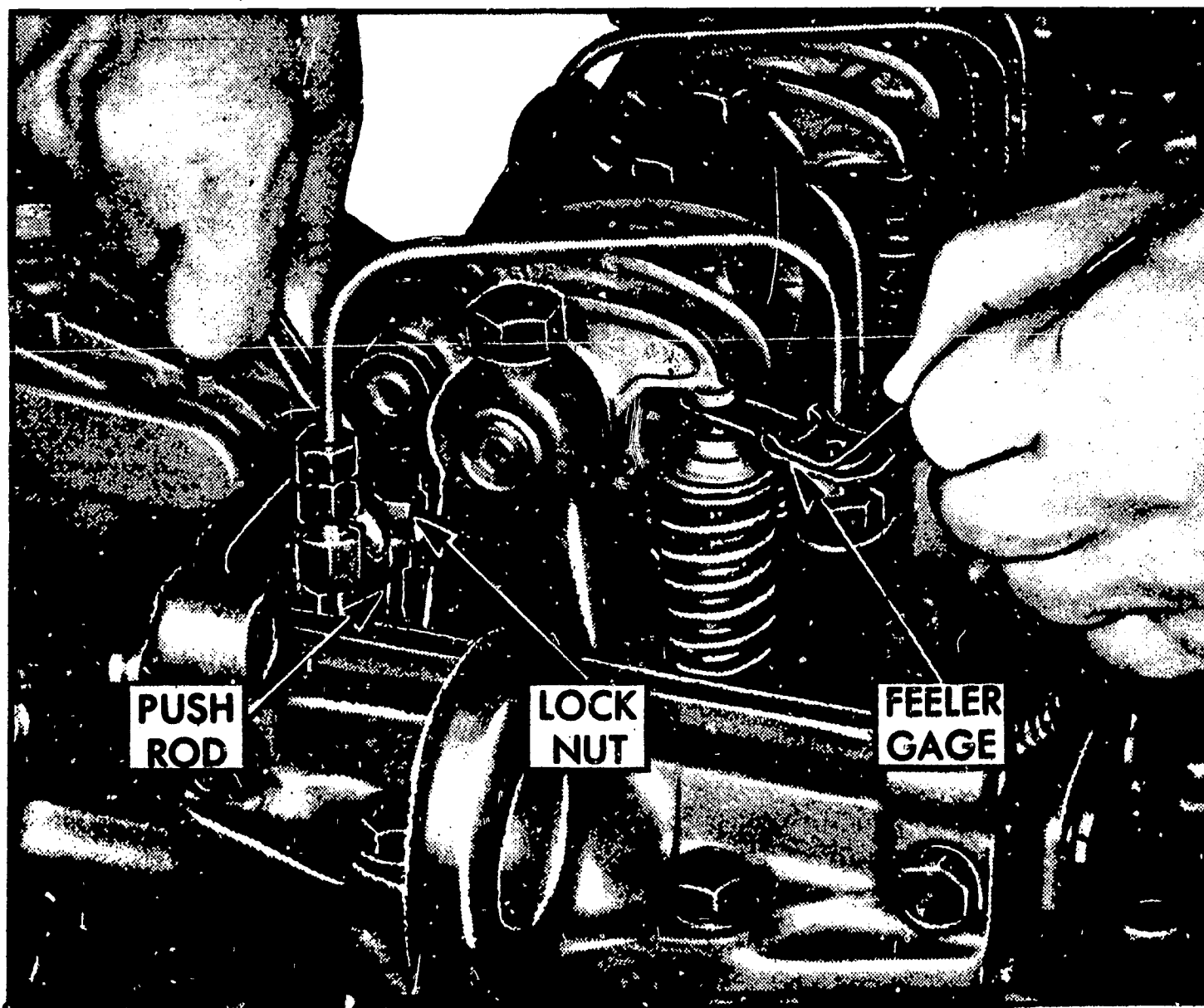

Fig. 1 - Adjusting valve clearance.

When performing valve clearance adjustment on a hot engine, remember that maintaining the normal engine operating temperature is particularly important when making the final valve clearance adjustment. If the engine is allowed to cool off before setting any of the valves, the clearance when running at full load may become insufficient.

With the engine at normal operating temperature (160 to 185 F), recheck the exhaust valve clearance with the feeler gage. At this time, if the valve clearance is correct, the .008" feeler gage will pass freely between the valve stem and the rocker arm, but the .010" gage will not pass through. Readjust the push rod, if necessary.

Performing Exhaust Valve Adjustment on Engines with Four Valve Cylinder Heads (Cold Engine) -- The above steps used to adjust valve clearance on engines with two valve cylinder heads are exactly the same as those used with engines having four valve cylinder heads except in steps 4, and 6, as follows.

In step 4 --- place a .017" feeler gage, tool J9708, between the end of the valve stem and the valve bridge adjustment screw (spring-loaded bridge only) or between the valve bridge and the valve rocker arm pallet (unloaded bridge only).

In step 6 -- recheck the clearance. At this time, if the adjustment is correct, the .015" feeler gage, J9708, will pass freely between the valve stem and the adjustment screw (spring-loaded bridge) or between the valve bridge and the rocker arm pallet (unloaded bridge), but the .017" feeler gage will not pass through.

With the engine at normal engine operating temperature (160 - 185 F.), recheck the exhaust valve clearance with the feeler gage. At this time,

if the valve clearance is correct, the .013" feeler gage must pass freely between the valve stem and the valve bridge adjusting screw (spring-loaded bridge) or between the valve bridge and the rocker arm pallet (unloaded bridge), but the .015" gage must not pass through. Readjust the push rod if necessary.

A good tip to remember is: after checking the adjustments, mark the rocker arm with chalk as you complete each one, to keep track of what has been done.

PERFORMING STEP No. 2 -- TIMING THE INJECTORS -- NOTE: Unless specified, the same procedure (below) is used on the inline series as on the Vee series.

Position the rocker arms for checking injector timing. Crank the engine until the push rod clevis ends of the valve rocker arms are up, fully depressing the exhaust valves.

Cranking the engine may be done by depressing the remote starter switch. Be sure the stop lever is in the stop position before cranking the engine. If you use a wrench on the crankshaft bolt or crankshaft nut, be sure not to turn the engine in a left-hand direction of rotation, as the bolts will be loosened.

All the injectors can be tuned during one full revolution of the crankshaft.

Use Table 1 to identify the proper timing gage necessary to turn the injector in your engine.

Injector	Timing Gage Dimension	Timing Gage Tool Number
50	1.484"	J 1242
TV55	1.484"	J 1242
HV55	1.484"	J 1242
55E	1.460"	J 1853
N55	1.460"	J 1853
S55	1.460"	J 1853
60	1.484"	J 1242
TV6	1.484"	J 1242
DF6	1.484"	J 1242
HV6	1.484"	J 1242
6E6	1.460"	J 1853
6E8	1.460"	J 1853
6S8	1.484"	J 1242
60E	1.460"	J 1853
HE6	1.460"	J 1853
N60	1.460"	J 1853
S60	1.460"	J 1853
N65	1.460"	J 1853
S65	1.460"	J 1853
70	1.460"	J 1853
HV7	1.460"	J 1853
N70	1.460"	J 1853
S70	1.460"	J 1853
80	1.460"	J 1853
HV8	1.460"	J 1853
N80	1.460"	J 1853
S80	1.460"	J 1853
90	1.460"	J 1853
HV9	1.460"	J 1853
S90	1.460"	J 1853

Table 1 - Timing gage chart for injectors

Time each fuel injector as outlined below:

1. Place the governor speed control lever in the NO-FUEL position.
2. Rotate the crankshaft until the exhaust valves are fully depressed on the particular cylinder to be timed.
3. Place the small end of the injector timing gage in the hole provided in the top of the injector body with the flat of the gage toward the injector follower, see Figure 2.
4. Loosen the push rod lock nut.
5. Turn the push rod and adjust the injector rocker arm until the extended part of the gage will just pass over the top of the injector follower.
6. Hold the push rod and tighten the lock nut. Check the adjustment and, if necessary, readjust the push rod.
7. Time the remaining injectors in the same manner as outlined in Items 1 through 6.

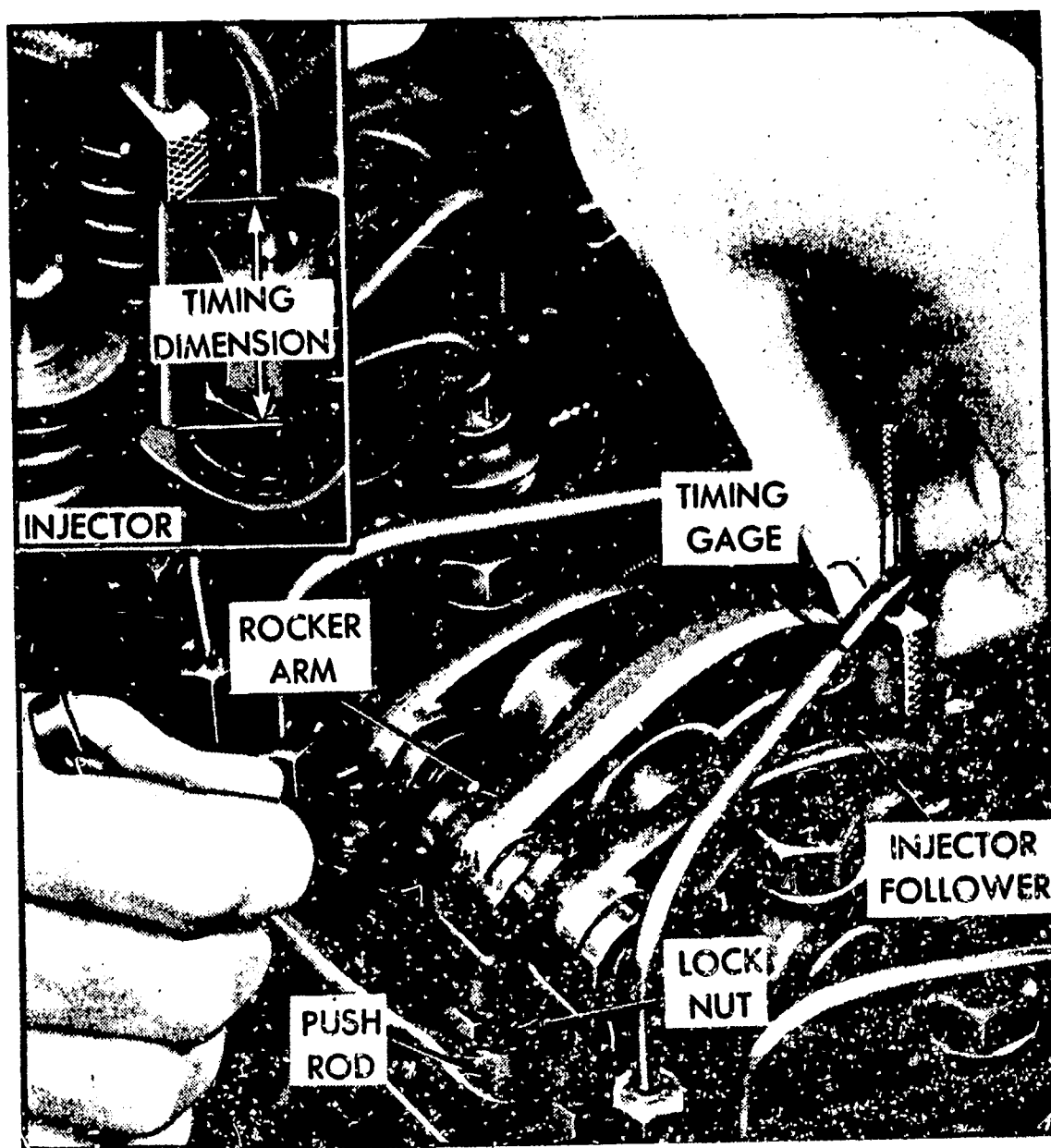

Fig. 2 - Inserting the injector timing gage.

PERFORMING STEP No. 3 -- LIMITING SPEED MECHANICAL GOVERNOR AND INJECTOR RACK CONTROL ADJUSTMENT - (INLINE)

After completing exhaust valve adjustment and injector timing, there are four governor adjustments to be made. They are:

1. Governor gap.
2. Idle speed.
3. Maximum speed.
4. Buffer screw.

The inline engines are equipped with either a single weight, or double weight limiting speed governor. The Vee engine has only the double weight. However, on the Vee engines, there are two types of double weight limiting speed governors. Differences in adjustments for both types will be pointed out in the following procedure.

ADJUSTING THE GOVERNOR GAP (INLINE SINGLE WEIGHT TYPE) --

With the engine at operating temperature, adjust the governor gap as follows:

1. With the engine stopped, remove two bolts and withdraw the governor high speed spring retainer cover.
2. Back out the buffer screw until it extends approximately 5/8" from the lock nut.
3. Start the engine and loosen the idle speed adjusting screw lock nut and adjust the idle screw to obtain the desired idle speed. Hold the screw and tighten the lock nut to retain the adjustment. The recommended idle speed is 550 rpm for single weight governors.
4. Stop the engine and remove the governor cover and lever assembly.
5. Remove the valve rocker cover.
6. Remove the fuel rod from the differential lever and the injector control tube lever.
7. Check the gap between the low speed spring cap (47) and the high speed plunger (44) with tool J 5407 (.170") as shown in Figure 3.
8. If required, loosen the lock nut (29) and turn the gap adjusting screw (28) until a slight drag is felt on the gage.
9. Hold the adjusting screw and tighten the lock nut.
10. Recheck the gap and readjust if necessary.
11. Install the fuel rod between the governor and injector control tube lever.
12. Install the governor cover and lever assembly.

28. Screw--Gap Adjusting
 29. Lock Nut
 44. Plunger--High Speed Spring
 47. Cap--Low Speed Spring
 263. Gage--Governor Gap-
 Tool J 5407

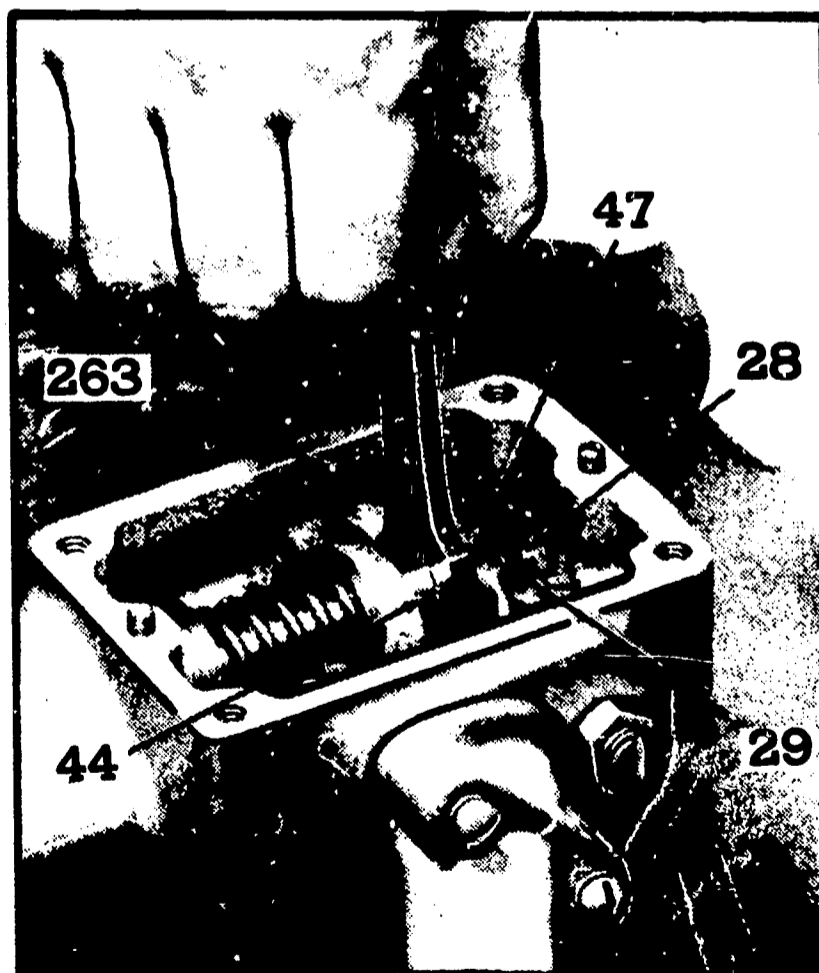

Fig. 3 Adjusting governor gap.

ADJUSTING THE GOVERNOR GAP (INLINE DOUBLE WEIGHT TYPE) --

With the engine at operating temperature, adjust the governor gap as follows:

1. With the engine stopped, remove the two bolts and withdraw the governor high speed spring retainer cover.
2. Start the engine. Then loosen the idle speed adjusting screw lock nut (56); see Figure 4. Turn the idle speed adjusting screw (55) to obtain the recommended idle speed. The recommended idle speed is 450 rpm for double weight governors, but may vary with special engine applications.
3. Remove the governor cover.
4. Remove the fuel rod from the differential lever and the injector control tube lever.
5. Start and run the engine between 800 and 1000 rpm by manual operation of the control tube lever.

2. Housing--Governor Control
27. Lever--Operating Shaft
28. Screw--Gap Adjusting
29. Lock Nut
44. Plunger--High Speed Spring
47. Cap--Low Speed Spring
48. Spring--High Speed
55. Screw--Idle Speed Adjusting
56. Lock Nut
264. Tube--Injector Control
265. Lever--Injector Control Tube
308. Feeler Gage Set-- Tool J 3172

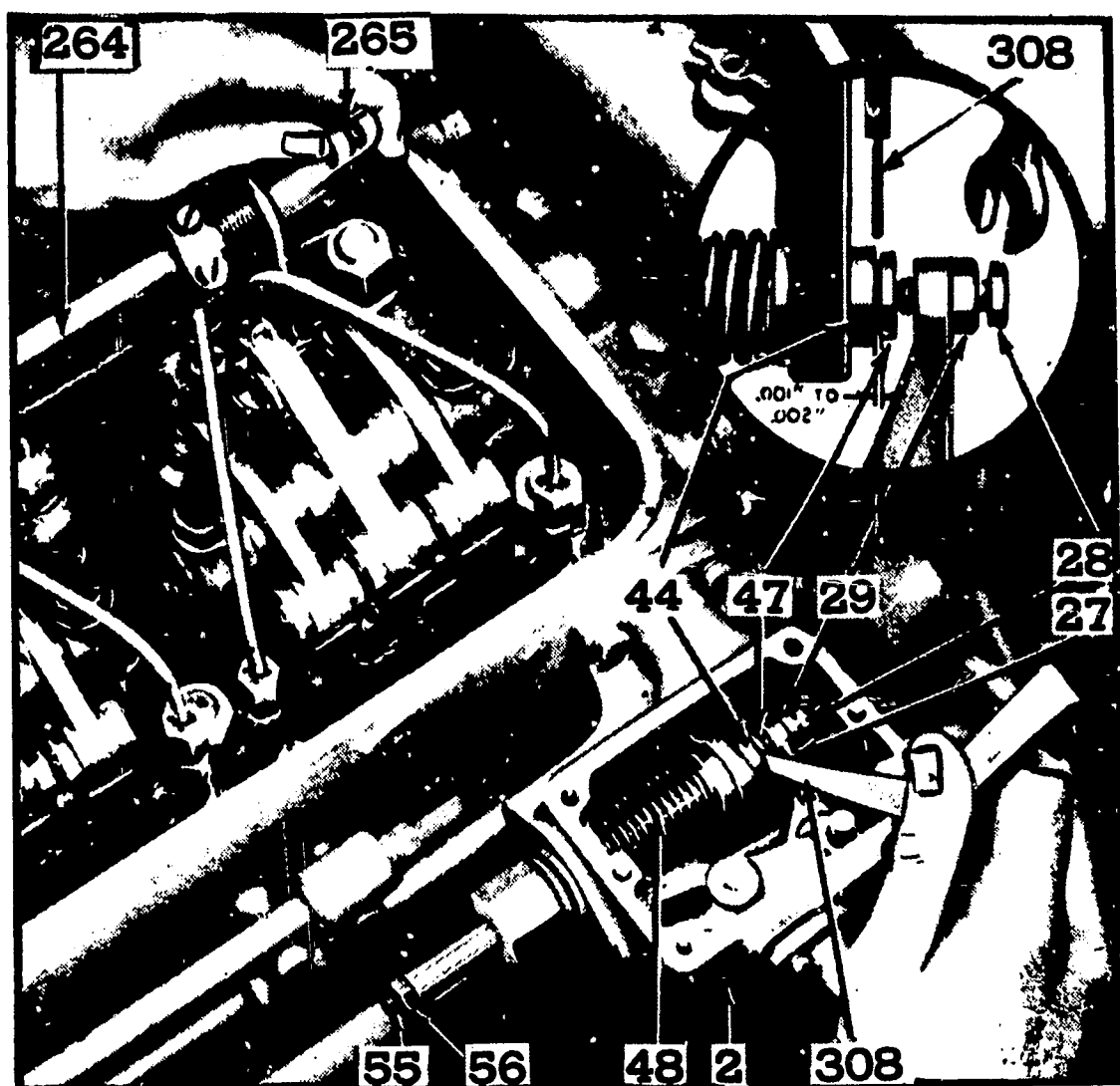

Fig. 4 Adjusting governor gap.

CAUTION: Do not overspeed the engine.

6. Check the gap between the low speed spring cap and the high speed plunger with a .0015" feeler gage. If the gap setting is incorrect, reset the gap adjusting screw.
7. Hold the gap adjusting screw and tighten the lock nut.
8. Recheck the governor gap, with the engine operating between 800 and 1000 rpm, by placing a screw driver between the gap adjusting screw, and the governor housing, and manually forcing the gap closed. If the setting is correct, the .0015" movement can be seen.

NOTE: The gap closing can be seen easily if a drop of oil is placed into the gap just before it is closed.

9. Stop the engine, and install the fuel rod between the differential lever and the control tube lever.
10. Install the governor cover.

Proceed with "Position Injector Control Racks-Engines Not Using a Fuel Modulator" if unit does not have a fuel modulator.

POSITIONING THE INJECTOR RACK CONTROL LEVERS -- INLINE --

The position of the injector racks must be correctly set in relation to the governor. Remember their position determines the amount of fuel injected into each cylinder and allows equal distribution of the load.

1. Adjust the idle speed adjusting screw until 1/2" of threads project beyond the lock nut.
2. Loosen the buffer screw lock nut and back out the buffer screw approximately 5/8", if not previously done.
3. Remove the valve rocker cover.
4. Loosen all the inner and outer injector rack control lever adjusting screws; see Figure 5. Be sure all the injector rack control levers are free on the injector control tube.
5. Move the speed control lever to the maximum speed position, hold in that position with light finger pressure. Turn inner adjusting screw on No. 1 injector rack control lever down until a step up in effort is noted. Turn down the outer adjusting screw until it bottoms lightly on the control tube. Then, alternately tighten both the inner and the outer adjusting screws. This will place the No. 1 injector in the full fuel position.

NOTE: The above step should result in placing the governor linkage and control tube assembly in the same position that they will reach while the engine is running at full load.

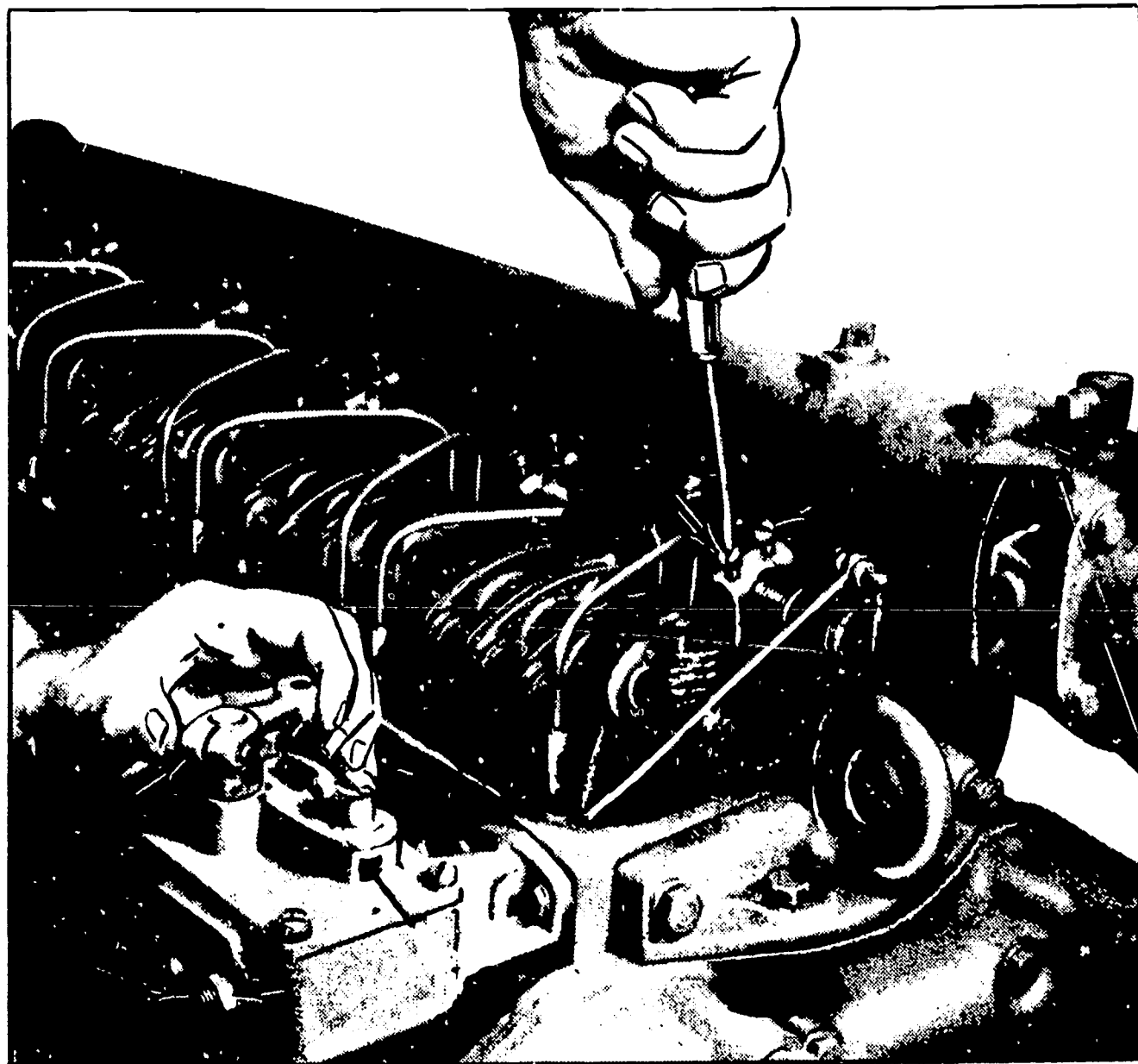

Fig. 5 - Positioning rack control levers.

6. To be sure the control lever is properly adjusted, the following check should be performed: Hold the speed control lever in the maximum speed position and press down on the injector rack with a screw driver or finger tip, causing the rack to rotate. The setting is sufficiently tight if the injector rack returns to its original position. If the rack does not return to its original position, it is too loose. To correct, back off the outer adjusting screw slightly and tighten the inner adjusting screw slightly. The setting is too tight if when moving the speed control lever from idle to maximum speed position, the injector rack becomes tight before the speed control lever reaches the end of its travel (as determined by the stop of governor cover). This will result in a step up in effort required to move the speed control lever to the end of its travel. To correct this, back off inner adjusting screw slightly and tighten the outer adjusting screw slightly.

Position Remaining Control Racks:

1. Manually hold No. 1 injector in the full fuel position and turn down the inner adjusting screw of the No. 2 injector until the injector rack has moved into the full fuel position and the inner adjusting screw is bottomed on the injector control tube. Turn the outer adjusting screw down until it bottoms lightly on the injector control tube. Then alternately tighten both the inner and outer adjusting screws until tight.
2. Recheck the No. 1 injector rack to be sure it has remained snug on the ball end of the injector rack control lever while positioning the No. 2 injector rack. If the rack of No. 1 has become loose, back off slightly the inner adjusting screw on the No. 2 injector rack control lever and tighten the outer adjusting screw. When the settings are correct, both injector racks must be snug on the ball end of their respective rack control levers.
3. Turn the idle speed adjusting screw in until it projects $3/8$ " from the lock nut, to permit starting the engine. Replace rocker cover on the engine.

Properly positioned injector rack control levers with engine at full load will result in the following:

1. Speed control lever at the maximum speed position.
2. Governor low speed gap closed.
3. High speed spring plunger on the seat in the governor control housing.
4. Injector fuel control racks in the full fuel position.

Adjusting the maximum no-load engine speed. Note: The maximum no-load speed of the engine must be checked at operating temperature. The best method of determining the engine rpm is with a hand tachometer. Normally, adjustment is only required if the governor has been reconditioned or replaced. Maximum engine speed should not exceed the recommended no-load speed as given on the unit option plate. The maximum no-load speed may be set as follows:

1. Loosen the lock nut and back off the high speed spring retainer approximately five turns.
2. With the engine at operating temperature and no-load on the engine, place the speed control lever in the maximum speed position. Turn the high speed spring retainer until the engine is operating at the recommended idle speed. Hold the spring retainer and tighten the lock nut.

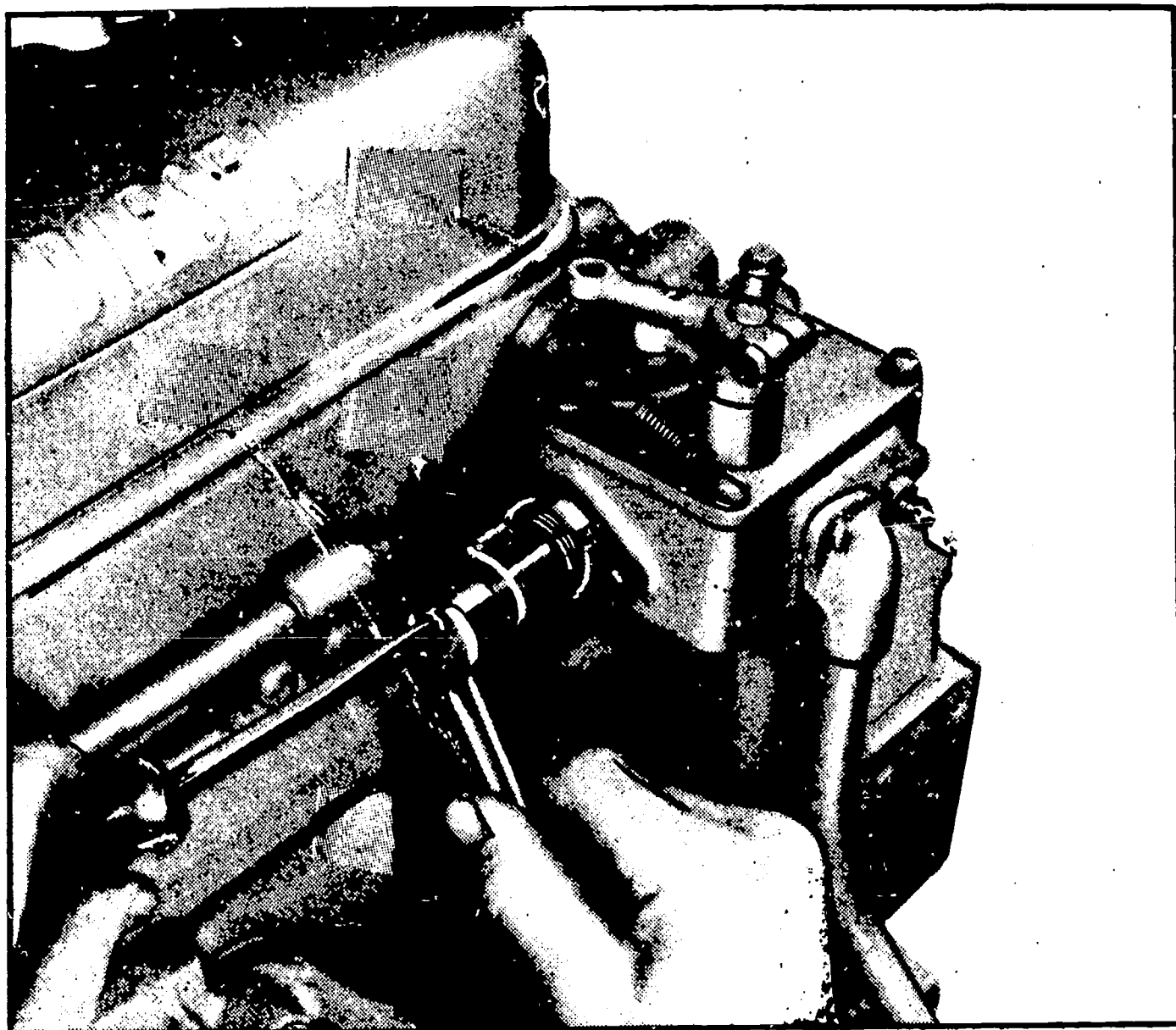

Fig. 6 - Adjusting idle speed.

Adjust Idle Speed - With the maximum no-load speed properly adjusted, the idle speed may be adjusted as follows:

1. With the engine at normal operating temperature and the buffer screw backed out, turn the idle speed adjusting screw until the engine is operating approximately 15 rpm below the recommended idle speed. NOTE: The recommended idle speed is 550 rpm for single weight governors, but may vary with engine applications.
2. Hold the idle screw and tighten lock nut. Replace high speed spring retainer cover.

Adjust Buffer Screw - With the idle speed set at approximately 15 rpm below the recommended idle speed, the buffer screw may be set as

follows:

1. Turn the buffer screw in until the engine is operating at the recommended idle speed.

NOTE: Do not raise the engine speed more than 15 rpm with the buffer screw.

2. Hold the buffer screw and tighten lock nut.

NOTE: On 71E engines, recheck maximum no-load speed. If it had increased more than 25 rpm, back off the buffer screw until speed increase is less than 25 rpm.

Reconnect throttle linkage to the governor. Check throttle linkage to find out if the speed control lever is in the maximum speed position when the throttle is in the maximum speed position.

That completes the tune-up of the inline 71 engine having a limited speed mechanical governor (single or double weight). Figure 7 below summarizes the sequence in which this procedure should be accomplished.

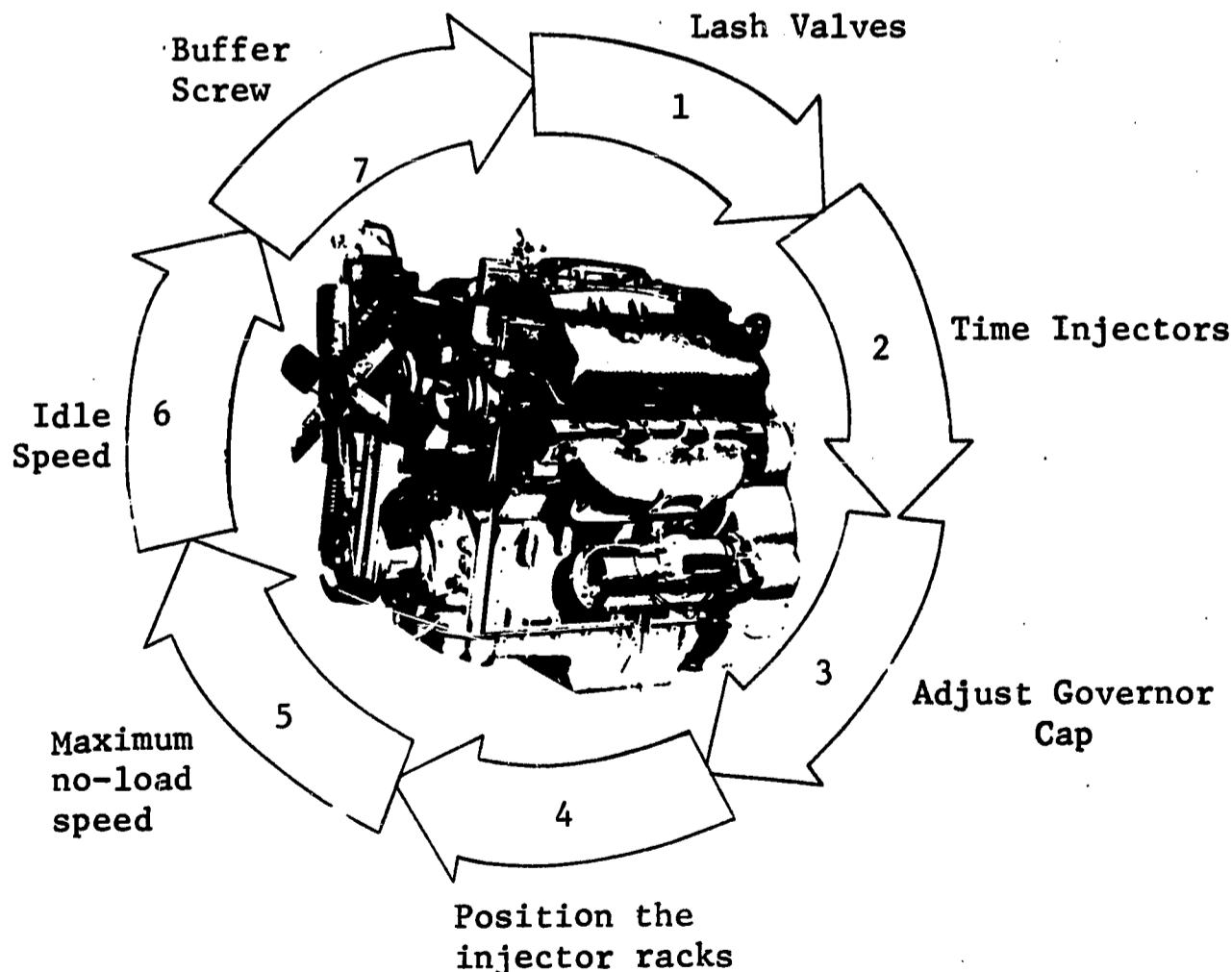

Fig. 7 - Summarizing tune-up.

With inline engines having dual range governors, check your maintenance manual for differences in procedure.

We will now go back to step No. 3 of tuning an engine, only this time the engine is a Vee series with a limiting speed mechanical governor.

Remember that up to step No. 3 in tuning an engine, there may be slight variations between the two types of engines, but basically the procedure is identical.

PERFORMING STEP No. 3 -- LIMITING SPEED MECHANICAL GOVERNOR AND INJECTOR RACK CONTROL ADJUSTMENT VEE-SERIES (6V, 8V and 12V-71 Engines)

After completing the exhaust valve adjustments and injector timing, there are four governor adjustments. They are:

1. Governor gap.
2. Maximum speed
3. Idle speed.
4. Buffer screw.

Position the control racks after the governor gap is checked.

ADJUSTING THE GOVERNOR GAP -- With the engine at operating temperature, set the governor gap as follows:

1. With the engine stopped, remove two bolts and withdraw the governor high speed spring retainer cover.
2. Back out the buffer screw until it extends approximately 5/8" from the lock nut.
3. Start the engine and loosen the idle speed adjusting screw lock nut and adjust the idle screw to obtain the desired idle speed.
4. Stop the engine and remove the governor cover and lever assembly.
5. Start and run the engine between 800 and 1000 rpm by manual operation of the differential lever as shown in Figure 8.

CAUTION: Do not over speed the engine.

6. With the engine operating between 800 to 1000 rpm, set the gap between the low speed spring cap and the high speed spring plunger at .0015" by adjusting the gap adjusting screw in the operating shaft lever.

7. Hold the gap adjusting screw and tighten the lock nut.
8. Recheck the governor gap, with the engine operating between 800 and 1000 rpm by placing a screw driver between the gap adjusting screw and the governor housing and manually forcing the gap closed. If the setting is correct, the .0015" movement can be seen.

NOTE: The gap closing can be easily seen if a drop of oil is placed into the gap just before it is closed.

9. Stop the engine and re-install the governor cover and lever assembly.

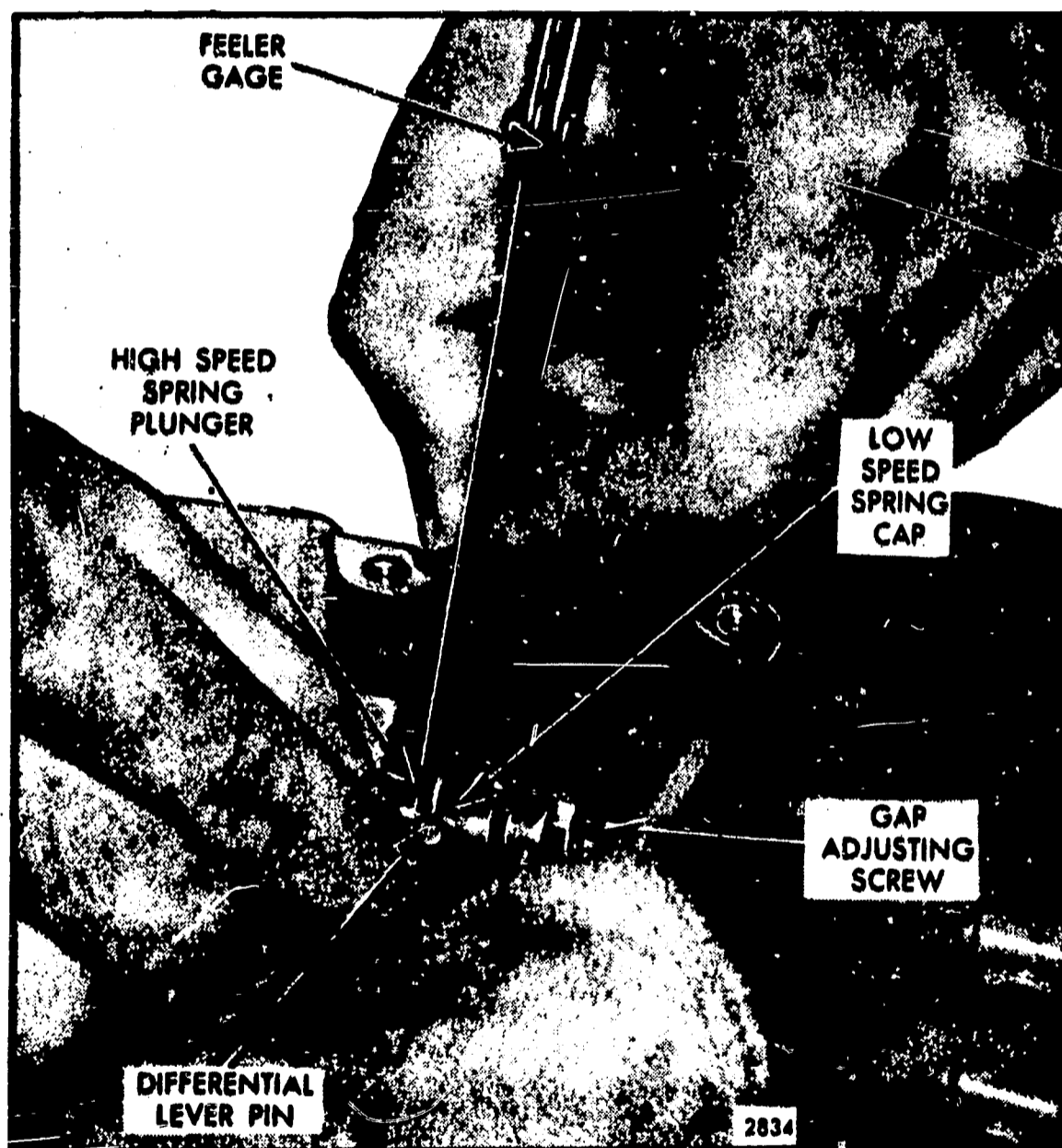

Fig. 8 - Inserting a feeler gage for governor gap.

POSITIONING INJECTOR RACK CONTROL LEVERS -- Properly positioned injector rack control levers with the engine at **FULL LOAD** will result in the following:

Speed control lever at the maximum speed position.

Governor low speed gap closed.

High speed spring plunger on the seat in the governor control housing.

Injector fuel control racks in the full-fuel position.

The letters R and L indicate the injector location in the right or left cylinder bank, viewed from the rear of the engine. Cylinders are numbered on each cylinder bank. Adjust the No. 1L injector rack control lever first to establish a guide for adjusting the remaining left bank injector rack control levers.

1. Disconnect any linkage attached to the governor speed control lever.
2. Adjust the idle speed adjusting screw until $1/2$ " of the threads (12 - 14 threads) project from the lock nut when the nut is against the high speed plunger.
3. Loosen the buffer screw lock nut and back out the buffer screw approximately $5/8$ ", if not previously set.
4. Remove the valve rocker covers.
5. Loosen all the inner and outer injector rack control lever adjusting screws on both cylinder heads. Be sure all the injector rack control levers are free on the injector control tubes.
6. Check for any bind in the governor to control tube linkage by moving the linkage through its full range of travel with one hand on the governor speed control lever and the other hand on one of the control tube levers.
7. Remove the clevis pin from the fuel rod and the right cylinder bank injector control tube lever.
8. Move the governor speed control lever to the maximum speed position; hold in that position with light finger pressure. Turn the inner adjusting screw on the No. 1L injector rack control lever down until a step in effort is noted (Figure 9). This will place the No. 1L injector rack in the full-fuel position. Turn down the outer adjusting screw until it bottoms lightly on the

injector control tube. Then alternately tighten both the inner and outer adjusting screws.

NOTE: The above step should result in placing the governor linkage and control tube assembly in the same position that they will reach while the engine is running at full load, as previously described.

CAUTION: Care should be used to avoid setting the injector rack too tight causing the fuel rod to bend.

9. To be sure the control lever is properly adjusted, the following check should be performed:

Hold the speed control lever in the maximum speed position and press down on the injector rack with a screw driver or finger tip, causing the rack to rotate. The setting is sufficiently tight if the injector rack returns to its original position.

If the rack does not return to its original position, it is too loose. To correct, back off the outer adjusting screw slightly and tighten the inner adjusting screw slightly.

The setting is too tight if, when moving the speed control lever from the idle to the maximum speed position, the injector rack becomes tight before the speed control lever reaches the end of its travel (as determined by the stop under the governor cover).

This will result in a step up in effort required to move the speed control lever to the end of its travel and a deflection in the fuel rod (fuel rod deflection can be seen at the bend). To correct this condition, back off the inner adjusting screw slightly and tighten the outer adjusting screw slightly.

10. Remove the clevis pin from the fuel rod and the left bank injector control tube lever.
11. Insert the clevis pin in the fuel rod and the right cylinder bank injector control tube lever and position the 1R injector rack control lever as previously outlined in Step 8.

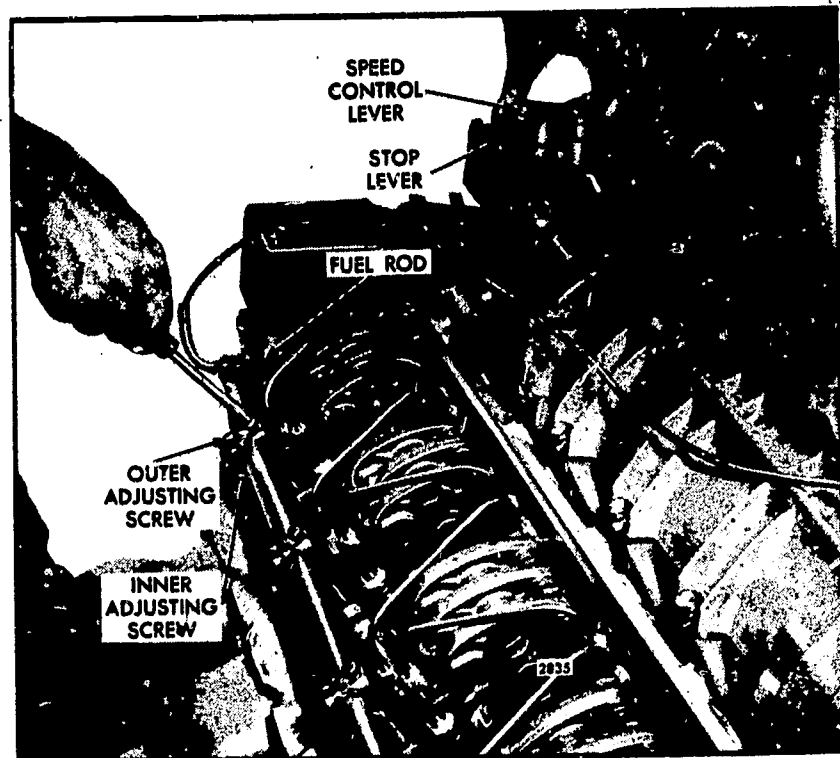

Fig. 9 - Positioning No. 1 injector rack control lever.

12. Insert the clevis pin in the fuel rod and the left bank injector control tube lever. Repeat the check on the 1L and 1R injector rack control lever as outlined in Step 9.

Carefully observe and eliminate any deflection which occurs at the bend in the fuel rod where it enters the cylinder head.

13. To adjust the remaining injector rack control levers, hold the No. 1L injector rack in the full fuel position by means of the lever on the end of the control tube assembly and turn down the inner adjusting screw of No. 2L injector rack control lever until the injector rack of No. 2L injector has moved into the full fuel position. Turn the outer adjusting screw down until it bottoms lightly on the injector control tube. Then alternately tighten both the inner and outer adjusting screws until tight.

Recheck the No. 1L injector rack to be sure that it has remained snug on the ball end of the injector rack control lever while positioning the No. 2L injector rack. If the rack of No. 1L injector has become loose, back off slightly the inner adjusting screw on the No. 2L injector rack control lever. Tighten the outer adjusting screw.

When the settings are correct, both injector racks must respond in the same manner on the ball end of their respective rack control levers as previously outlined in Step 9.

14. Position the remaining injector rack control levers as outlined in Step 13 on the left bank.
15. Position the right cylinder bank injector rack control levers as outlined above for the left cylinder bank in Step 13.
16. Turn the idle speed adjusting screw in until it projects $3/16''$ from the lock nut, to permit starting the engine.

ADJUST IDLE SPEED

The idle speed may be adjusted as follows:

1. With the engine running, at normal operating temperature and with the buffer screw backed out to avoid contact with the differential lever, turn the idle speed adjusting screw until the engine idles at the recommended idle speed. See Figure 10.

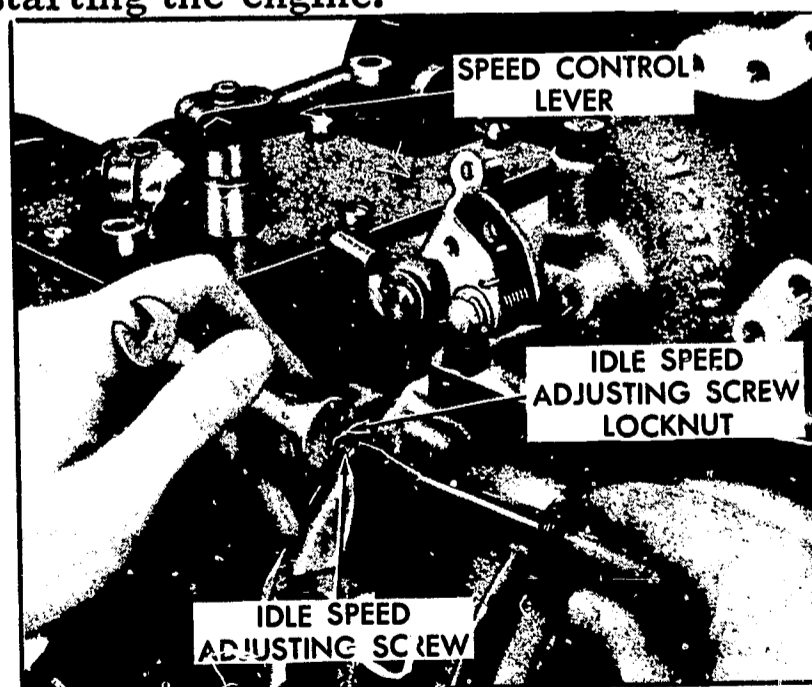

Fig. 10 - Adjusting engine idle speed.

NOTE: It may be necessary to use the buffer screw to eliminate the engine roll. Back out the buffer screw after the idle speed is established at the previous setting (5/8").

The recommended idle speed is 400-450 rpm, but may vary with special engine applications.

2. Hold the idle screw and tighten the lock nut.
3. Install the high speed spring retainer cover.

ADJUSTING MAXIMUM NO-LOAD ENGINE SPEED -- All governors are properly adjusted before leaving the factory. However, if the governor has been reconditioned or replaced, and to ensure the engine speed will not exceed the recommended no-load speed as given on the unit nameplate, the maximum no-load speed may be set as outlined below.

After positioning the injector rack control levers and setting the idle speed, set the maximum engine speed as follows:

NOTE: Be sure the buffer screw projects 5/8" from the lock nut to prevent interference while adjusting the maximum no-load speed.

1. Loosen the spring retainer lock nut (Figure 11) and back off the high speed spring retainer approximately five turns.
2. With the engine running at operating temperature and no-load on the engine, place the speed control lever in the maximum speed position. Turn the high speed spring retainer until the engine is operating at the recommended no-load speed.
3. Hold the high speed spring retainer and tighten the lock nut.

Fig. 11 - Adjusting Maximum No-Load Speed

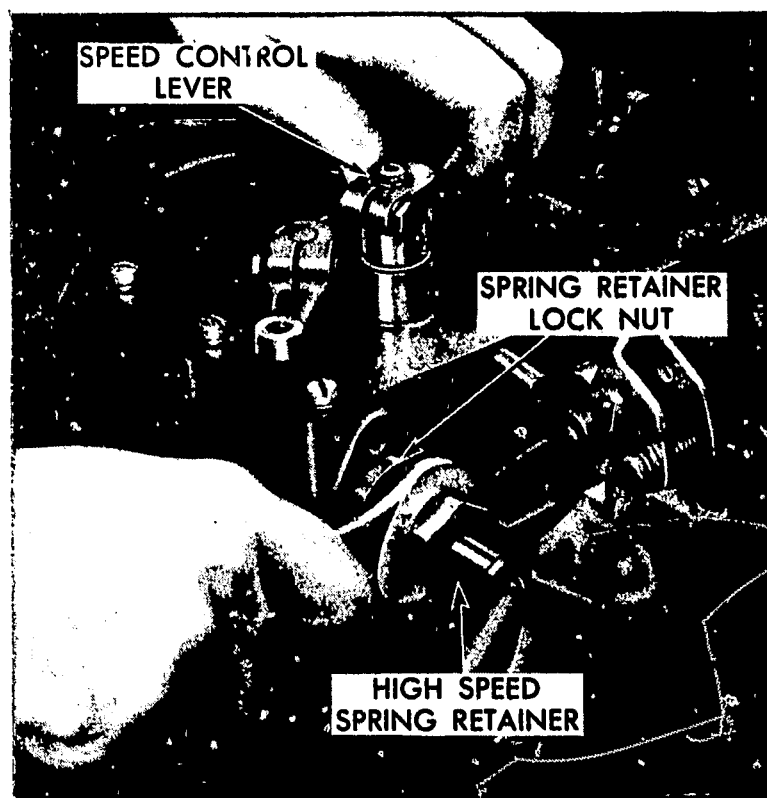

Adjusting the Buffer Screw

With the idle speed set, the buffer screw may be adjusted as follows:

1. With the engine running at normal operating temperature, turn the buffer screw (Figure 12) in so that it contacts the differential lever as lightly as possible and still eliminates the engine roll.

NOTE: Do not increase the engine idle speed more than 15 rpm with the buffer screw.

2. Hold the buffer screw and tighten the lock nut.
3. Recheck the maximum no-load speed. If it has increased more than 25 rpm, back off the buffer screw until the increase is less than 25 rpm.

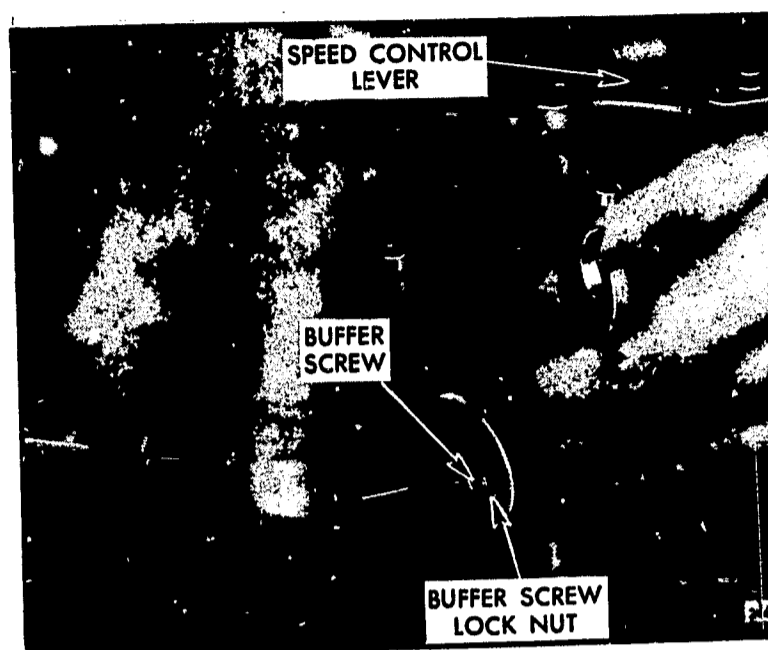

Fig. 12 - Adjusting buffer screw

PERFORMING STEP No. 3 -- LIMITING SPEED MECHANICAL GOVERNOR AND INJECTOR RACK CONTROL ADJUSTMENT (16V 71 Engine) -- Prior to performing adjustment on the governor gap, there are some preliminary steps that must be followed. These steps are as follows:

1. Disconnect the linkage to the governor speed control and shut-down levers, see Figure 13.
2. Remove the covers from the governor housing and auxiliary control link housing.
3. Disconnect the adjustable link from the lever in the auxiliary control link housing.
4. Remove the connecting pin from the auxiliary governor control link lever.

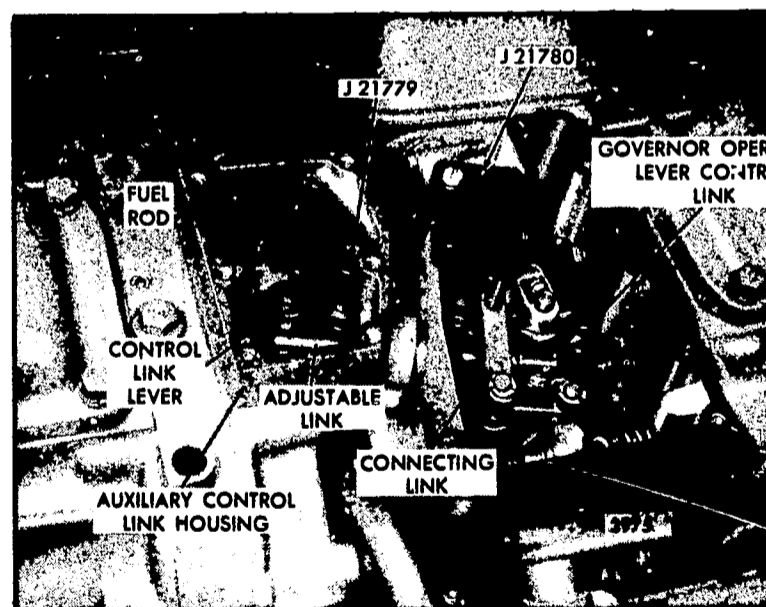

Fig. 13 - Positioning control link levers.

5. Install gage J 21779 so it extends through the lever and fuel rod and into the gage hole in the bottom of the housing. With the gage in place, the auxiliary control link lever will be in the mid-travel position.
6. Remove the connecting pin from the control link lever in the governor housing and install gage J 21780. Install the gage so the pin extends through the connecting link, control lever, and fuel rod; and the governor housing dowel pin extends into the small hole in the gage. Then install a governor cover bolt as shown in Figure 13 to lock the gage in place. With gage J 21780 in place, the governor control link lever will be in the mid-travel position and parallel to the auxiliary control link lever.
7. Adjust the length of the adjustable connecting link to retain the lever positions obtained in Steps 5 and 6 and install the link.
8. Remove gages J 21779 and J 21780 and reinstall the control link lever connecting pins.
9. Install the governor housing and auxiliary control link housing covers.

Proceed with the governor and injector rack control adjustment.

Adjusting the Governor Gap -- Adjusting the governor gap on the 16V engine is identical to adjusting the gap on the 6V, 8V and 12V engines. Refer to page 16 for this procedure.

Positioning the Injector Rack Control Levers -- Positioning the injector rack control levers on the 16V engine is the same as on the 6V, 8V, and 12V engines, except Step 8 and Step 10 through 15 should read:

- Step 8. Move the governor speed control lever to the maximum speed position; hold the stop lever in the run position with light finger pressure and adjust the No. 4R injector rack by turning the inner adjusting screw down until a slight movement of the control tube is observed or a step-up in effort is noted, see Figure 14. This will place the rack in full-fuel position. Turn the outer adjusting screw until it bottoms lightly on the control tube. Then, tighten both the inner and outer adjusting screws alternately. Do not set the rack too tight, this may cause the fuel rack to bend.
- Step 10. Remove the fuel rod-to-control tube lever clevis pin from the right front bank fuel rod and install it on the right rear bank fuel rod and adjust the No. 5R injector rack as outlined in Steps 6, 7 and 8.

- Step 11. Repeat Step 10 for adjustment of the No. 4L and 5L injector racks. When the settings are correct, the No. 4R, 5R, 4L and 5L injector racks will be snug on the ball end of the control levers when the injectors are in the full-fuel position.

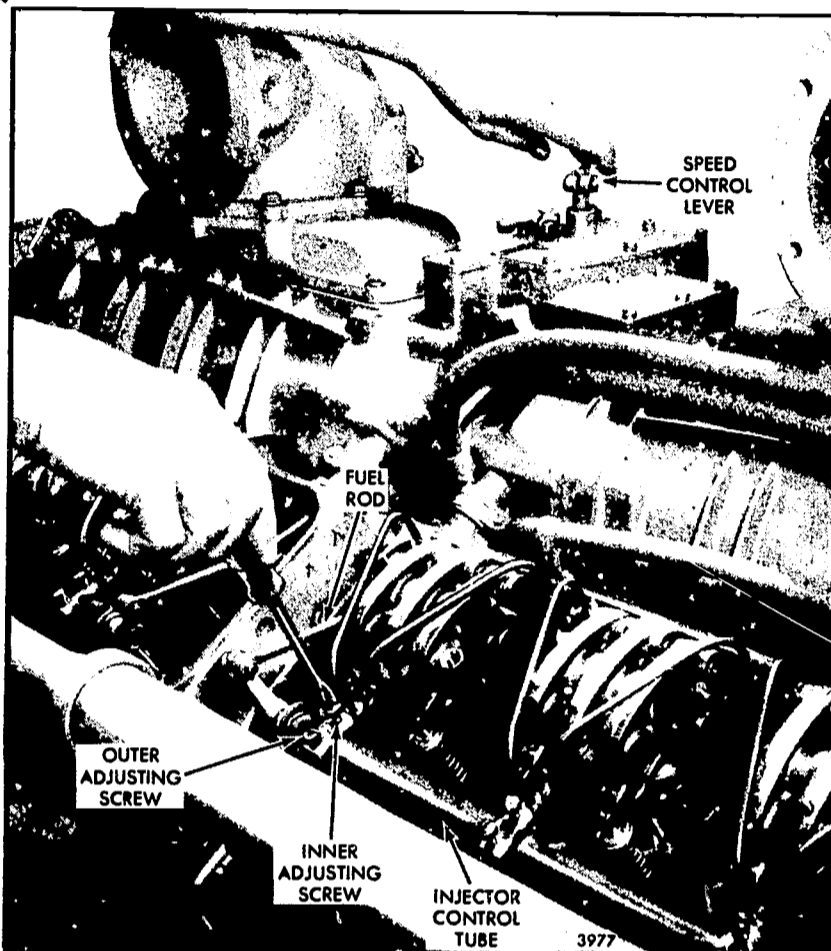

Fig. 14 - Positioning No. 4R injector control lever.

- Step 12. With the fuel rod disconnected from the injector control tube lever, adjust the remaining injector rack control levers on the right front bank. Hold the No. 4R injector rack in the full-fuel position by means of the control tube lever and turn the inner adjusting screw of the No. 3R injector rack control lever until the injector rack has moved into the full-fuel position. Turn the outer adjusting screw down until it bottoms lightly on the injector control tube. Then, alternately, tighten both the inner and outer adjusting screws.
- Step 13. Recheck the No. 4R injector rack to be sure it has remained snug on the ball end of the injector rack control lever. If the rack of the No. 4R injector has become loose, back off the inner adjusting screw slightly on the No. 3R injector rack control lever and tighten the outer adjusting screw. When the settings are correct, both injector racks must respond in the same manner on the ball ends of the control levers when the injector control tube lever is held in the full-fuel position.
- Step 14. Position the remaining injector rack control levers on the right front cylinder bank as outlined in Steps 12 and 13.

Step 15 Adjust the remaining injector rack control levers on the right rear, left front and left rear cylinder banks in the same manner as outlined in Steps 12, 13 and 14.

Install the four fuel rod-to-control tube lever clevis pins and check the adjustment of the injector rack control levers.

Adjusting the Idle Speed - Adjusting the idle speed on a 16V engine is the same as on the 6V, 8V and 12V engines. Refer to page 20 for this procedure.

Adjusting the Maximum No-Load Engine Speed -- Adjusting the maximum no-load engine speed on the 16V engine is the same as on the 6V, 8V and 12V engines. Refer to page 21 for this procedure.

Adjusting the Buffer Screw -- Adjusting the buffer screw on the 16V engine is the same as on the 6V, 8V and 12V engines. Refer to page 22 for this procedure.

That completes the tune-up of the Vee series engine with a limiting speed mechanical governor. Figure 15 summarizes the sequence in which this procedure should be accomplished.

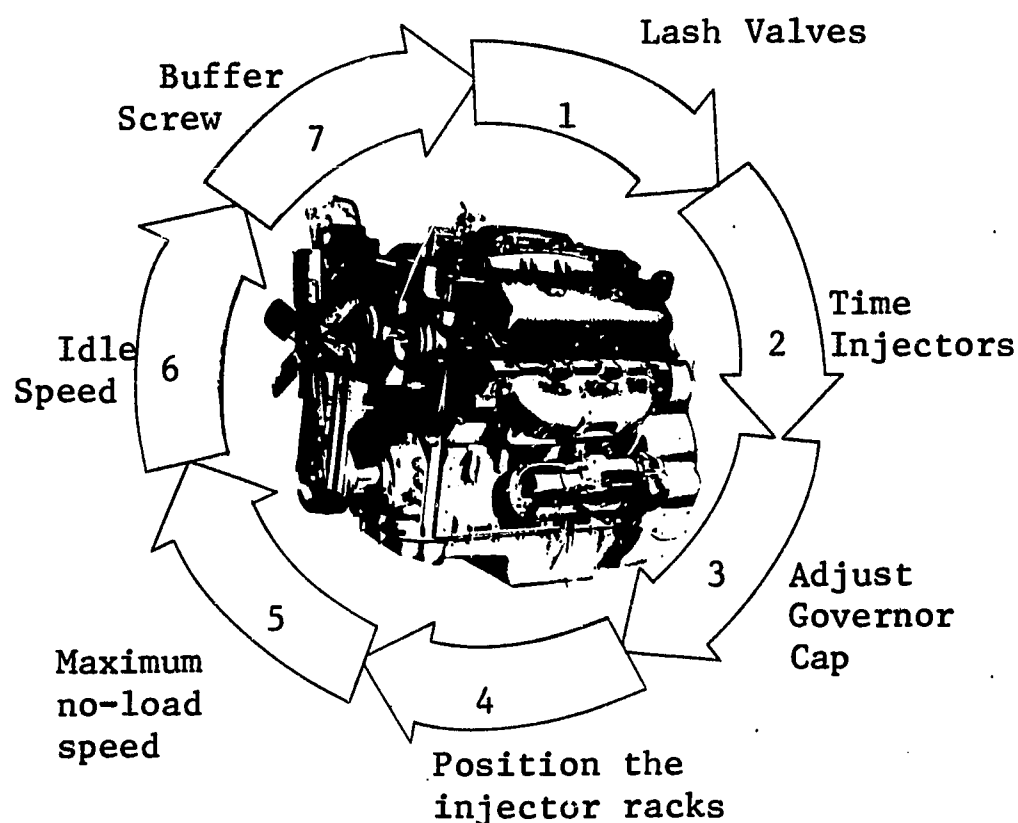

Fig. 15 - Summarizing engine tune-up.

TROUBLESHOOTING TIPS

1. When the engine is hard to start -- it may not be getting fuel. Check for the injector racks not being properly positioned.

2. When getting low compression -- there may be an improper valve clearance -- readjust them making sure to follow the tune-up steps in sequence.

3. When you are getting abnormal engine operation, such as lack of power or rough engine operation -- check for a faulty tune-up.

DIDACTOR PLATES FOR AM 1-7D
ENGINE TUNE-UP -- DETROIT DIESEL ENGINE

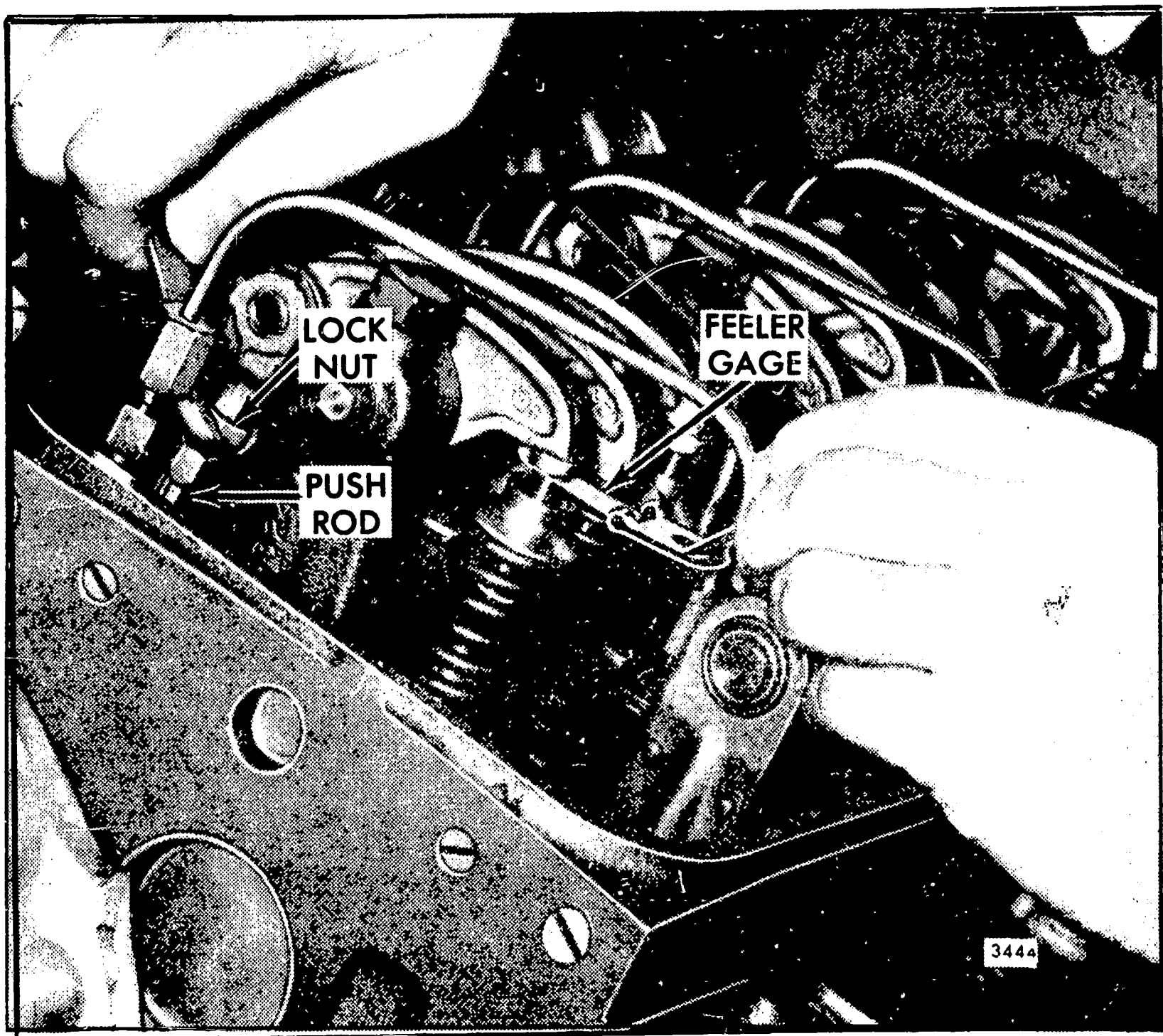

Plate I -- Adjusting valve clearance.

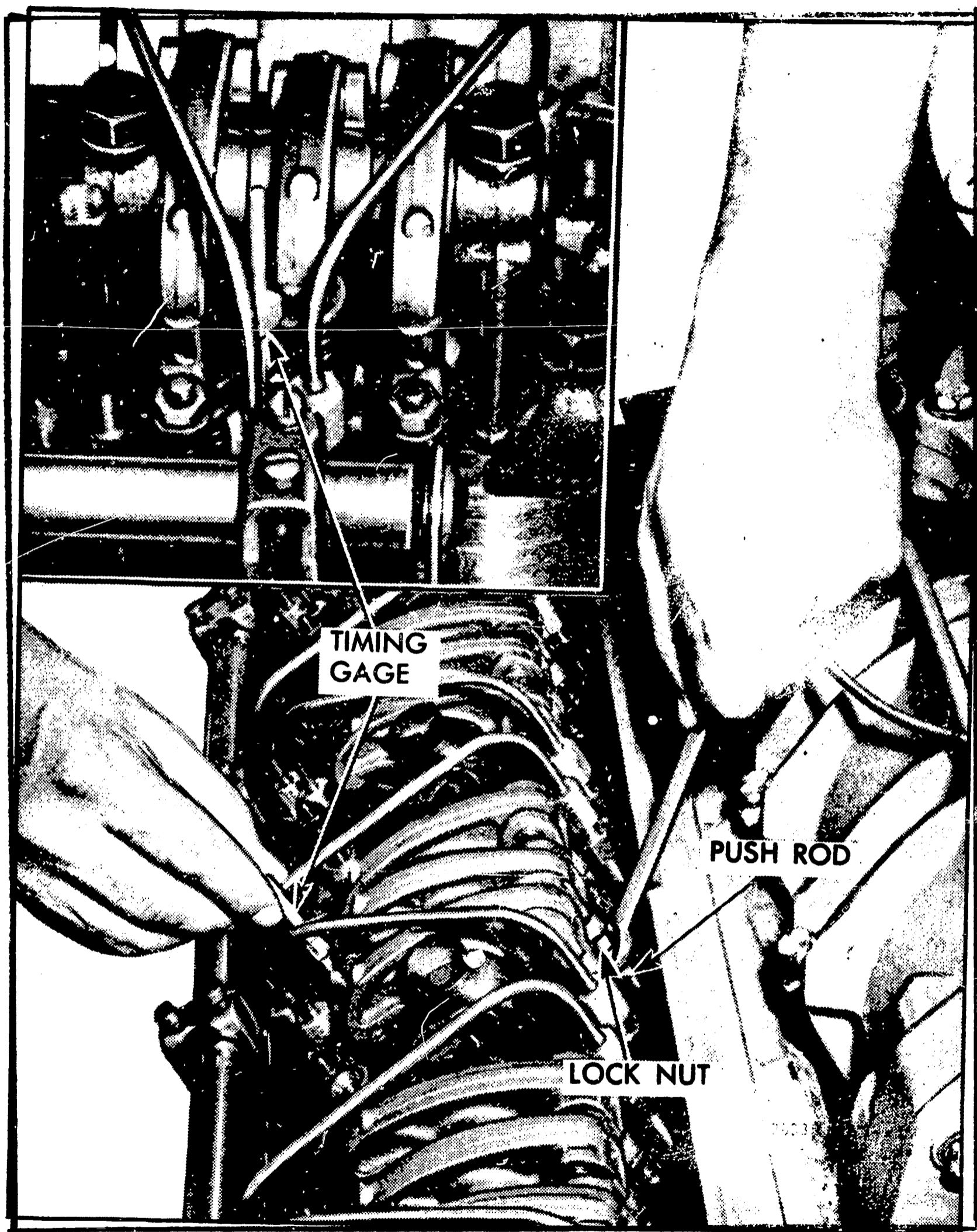

Plate II -- Timing fuel injector.

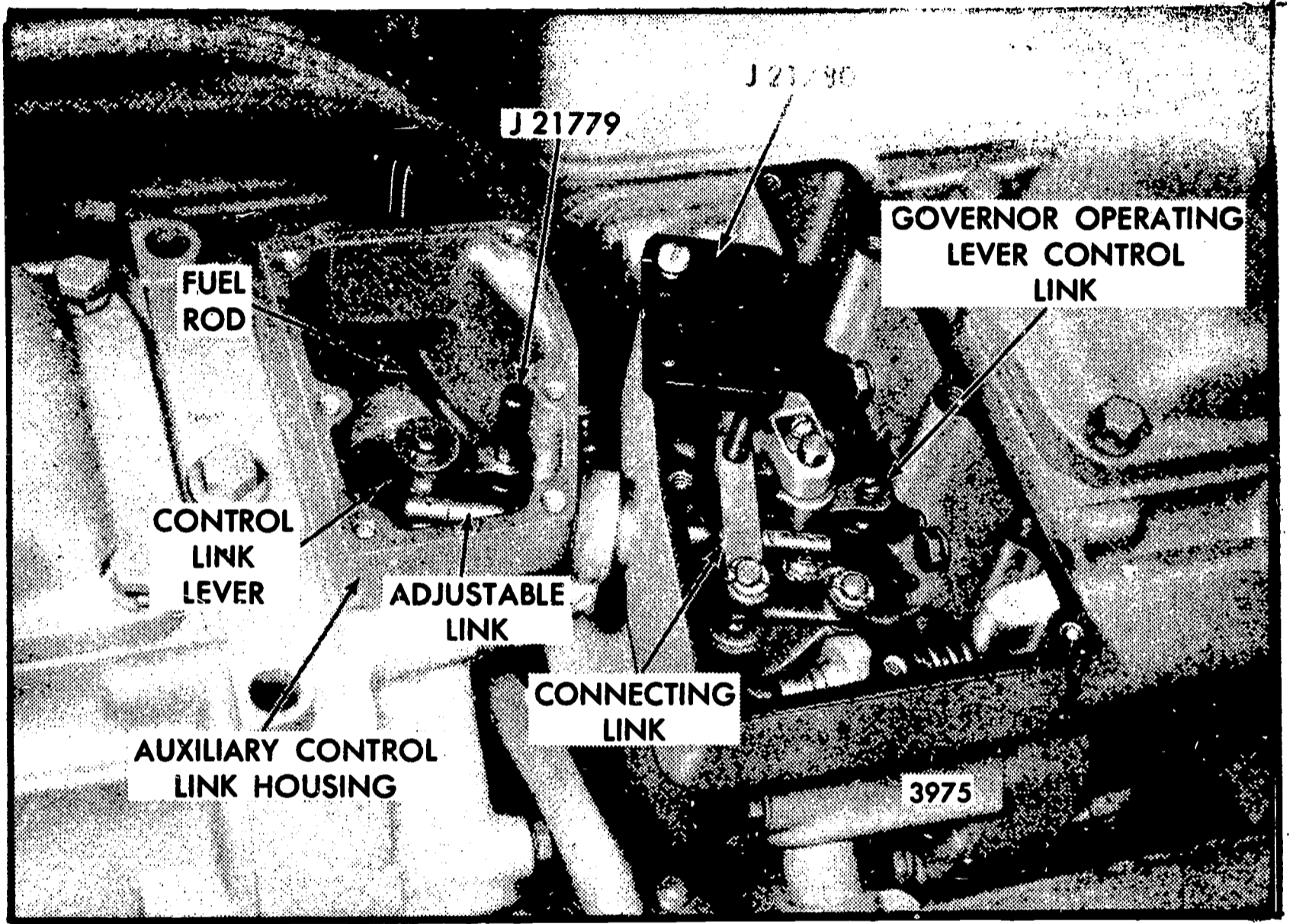

Plate III -- Positioning control link levers.

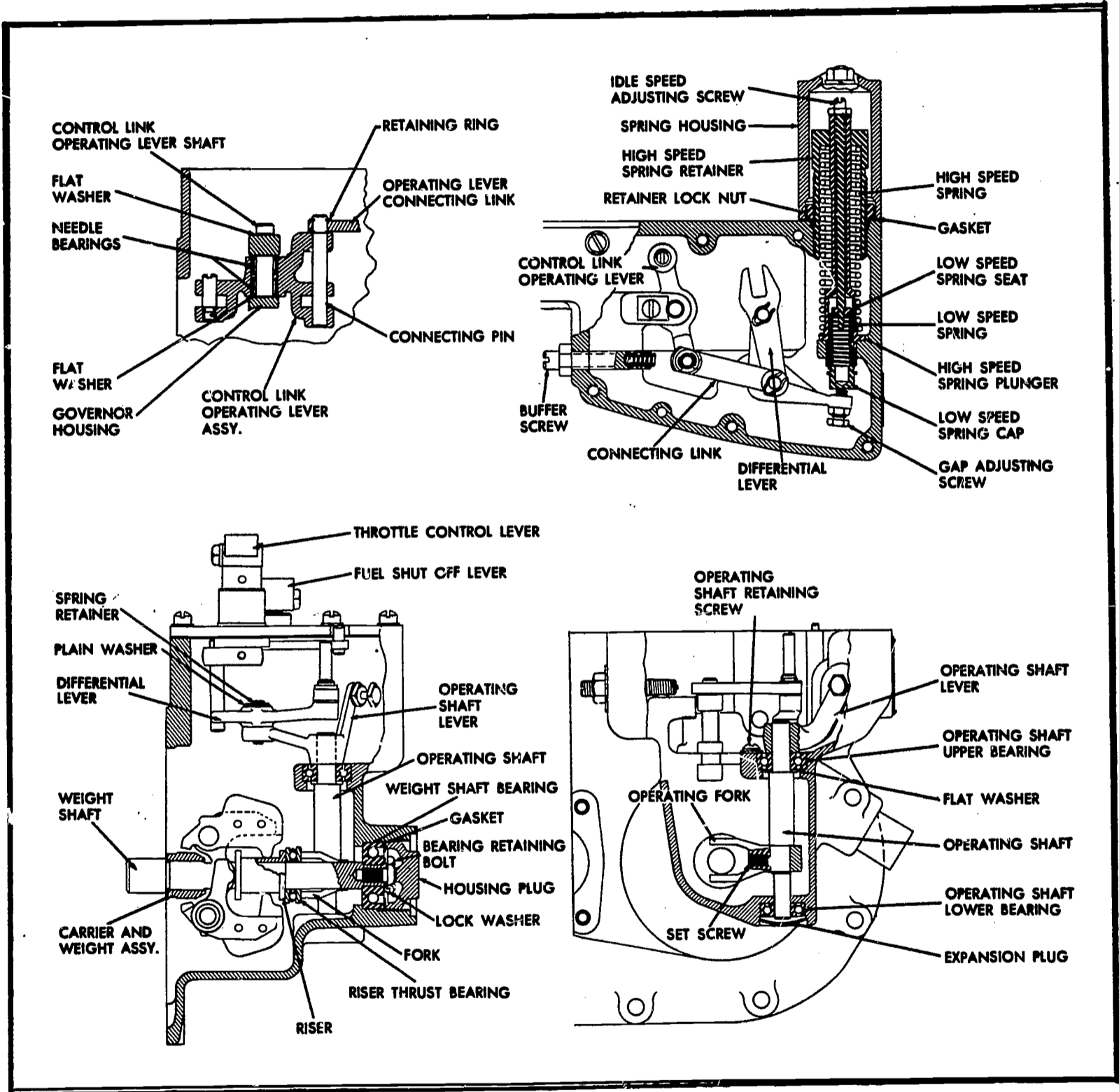

Plate IV -- Cross sections of limiting speed governor.

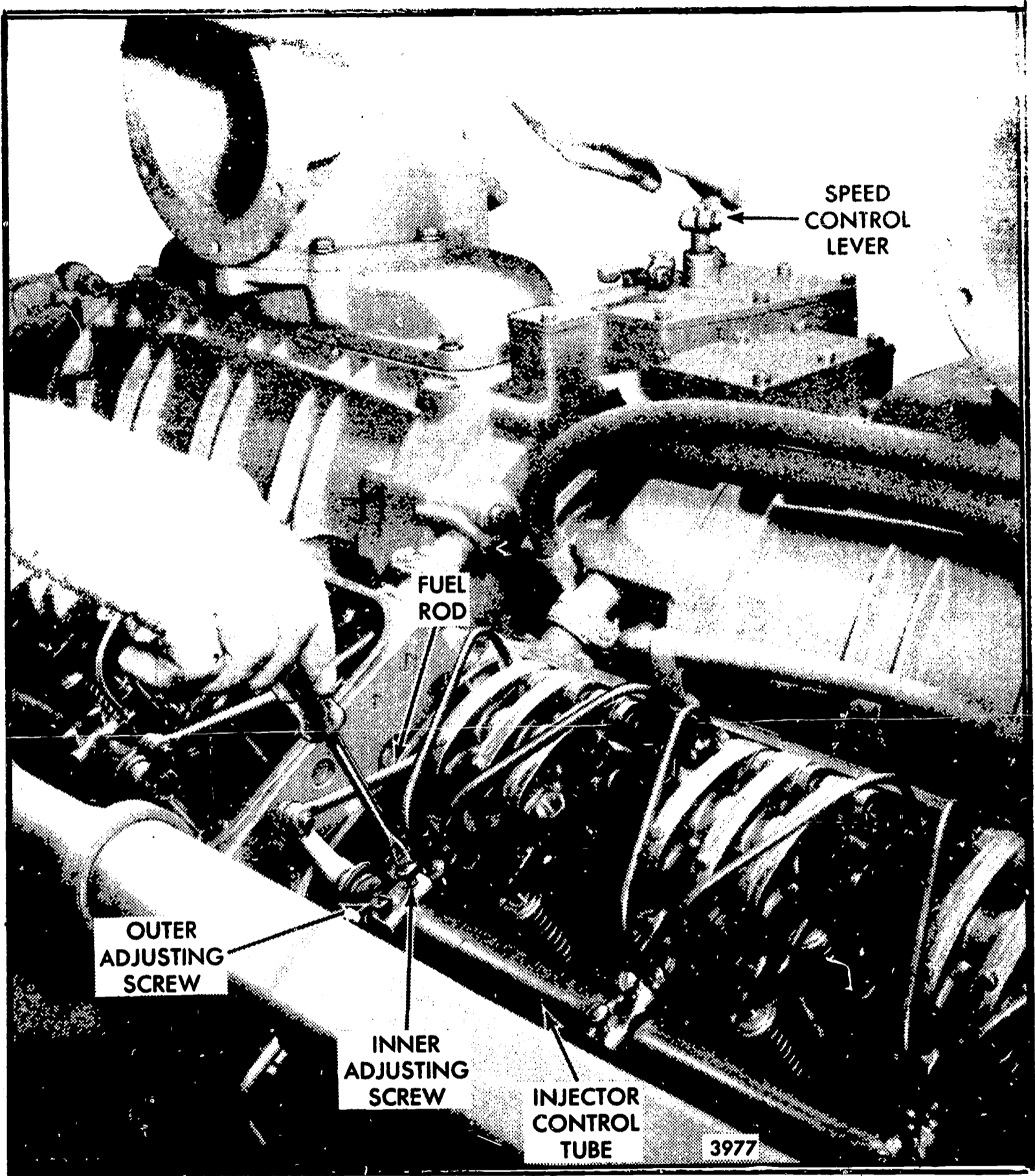

Plate V -- Positioning No. 4R injector rack control lever.

AM 1-7D

①

ENGINE TUNE-UP - DETROIT DIESEL ENGINE

Human Engineering Institute

December 1965

Press A → 2

1

The most important thing to remember about tune-up of an engine is to know when to do it. A tune-up is necessary when:

1. A new engine is installed.
2. A new engine has run for 100 hours.
3. Performance is unsatisfactory.
4. An engine has been overhauled.
5. The cylinder head assembly has been serviced.

Which of the following conditions would require an engine tune-up? (Select one).

- A. The oil filter has been replaced. → 3
- B. After an oil change. → 4
- C. The valves have been ground. → 5

1

No. Changing of the oil filter will not affect the tune-up of an engine in service. The correct answer is "after the valves have been ground". To grind the valves, the engine head has to be removed; this is when a tune-up is needed.

Press A → 5

1

No. Performing an oil change does not alter the tune-up of an engine. The correct answer is "when the valves are ground". To grind the valves of an engine, the head must be removed. Remember: we said that when the cylinder head is serviced, a tune-up is required.

Press A → 5

1

OK. Whenever we work on the head we must do a tune-up. Since adjusting the valve clearance is the first step in a tune-up sequence, it is logical that a tune-up is mandatory after a valve job.

All governors for GM engines are clearly marked for identification. A governor marking such as DW-LS would mean _____.

- A. dual weight - low speed → 6.
- B. double width - limiting speed → 7
- C. double weight - limiting speed → 8

1

No. Your answer is incorrect. DW-LS means the governor is a double weight - limiting speed type. Just as the SW-VS means it's a single weight - variable speed. This information is important when reordering parts or tuning an engine.

Press A → 8

No. You are guessing. Perhaps you should glance through the Unit, AM 1-7, before continuing this tape. Read carefully.

Press A → 8

1

"Double weight - limiting speed" is the correct answer.

We must make the final tune-up of an engine at operating temperature because _____.

- A. most governors will not operate at cold temperature. → 9
- B. the valve clearance is critical and must be set while at operating temperature. → 10
- C. settings made on a cold engine will change when the engine heats up. → 11

1

No. You are guessing. Governors will operate whether hot or cold. The point is that all final settings must be made while the engine is at operating temperature, because those made on a cold engine will change when the engine heats up.

Press A

1

True. The valve clearance is critical when tuning an engine, but the valve setting is not the only one that is critical. All final settings must be made when the engine is at operating temperature, because those made on a cold engine will change when the engine heats up.

Press A

1

"Settings made on a cold engine will change when the engine heats up" is the correct answer.

To maintain operating temperatures when tuning an engine, we might have to _____

- A. start the engine periodically between adjustments. - 17
- B. check the maintenance manual for cold settings and arbitrarily increase the settings accordingly. - 12
- C. heat up the engine way above normal so the heat will last throughout the adjustments. - 12

1

Your answer is incorrect. Tolerances are very critical on diesel engines in order to maintain efficiency, and maximum operation. Never guess at the adjustments; always check the manual and use the correct tools and procedures when tuning an engine.

Let's move on.

Press A

1

"Start the engines periodically between adjustments" is the correct answer. The normal operating temperature is between 160 and 180 F. Remember: we said that metal expands when it gets hot, and contracts when it gets cold. So a setting of .017 on a cold engine might be .013 when the engine gets hot.

Press A

1

The correct exhaust valve clearance at normal engine operating temperature is important for smooth, efficient operation of the engine. Insufficient valve clearance can result in loss of compression, misfiring cylinders, and eventually burned valve seats and valve seats.

The reason for this is that the _____ are trapped within the cylinder. (Which of the following best fits the blanks?)

- A. unburned carbons - 15
- B. exhaust gases - 16
- C. neither A or B - 15

"Exhaust gases" is the correct answer.

No. Your answer is incorrect. Remember, the exhaust valves must open fully to allow the exhaust gases to escape after the explosion. Low openings can cause burned valve seats, etc. because the exhaust gases are trapped in the cylinder.

Press A

1

Whenever the cylinder head is overhauled -- whether it be the exhaust valves reconditioned or replaced, or the valve mechanism replaced or disturbed in any way -- the valve clearance must first be adjusted to the cold setting to allow for normal expansion of the engine parts during the engine warm-up period. This will insure a valve setting that is close enough to the specified clearance to prevent damage to the valves when the engine is started.

Press A

1

17

You have missed one or more of the questions in this sequence of material. Before going on to actually performing exhaust valve clearance, you should review some of the previous questions and answers. When you press A, the Didactor will take you back for this review. Please read carefully and take your time in answering.

Press A → 2

1

18

It is extremely important to follow a set sequence of steps when tuning an engine. Any variation in this procedure will result in a sloppy tune-up. Keep these steps in mind:

1. Adjust the exhaust valve clearance.
2. Time the fuel injectors.
3. Adjust the governor gap.
4. Position the injector rock control levers.
5. Adjust the maximum no-load speed.
6. Adjust the idle speed.
7. Adjust the buffer screw.
8. Check the linkage and throttle movement.

Press A - 19

2

19

The first step in the tune-up sequence is to _____

- A. check the linkage and throttle movement. - 20
- B. adjust the exhaust valve clearance. - 22
- C. time the fuel injectors. - 21

2

20

No. Your answer is incorrect. Checking the linkage and throttle movement is the last step of the tune-up sequence. The first step is to adjust the exhaust valve clearance.

Press A - 22

2

21

No. Your answer is incorrect. Before timing the fuel injectors you would adjust the exhaust valve clearance. This is the first step of the tune-up sequence.

Press A - 22

2

22

"Adjust the exhaust valve clearance" is the first step in the tune-up sequence.

After adjusting the exhaust valve clearance, the next step is to _____

- A. time the fuel injectors. - 25
- B. adjust the governor gap. - 23
- C. check the linkage and throttle movement. - 24

2

23

No. Your answer is incorrect. After adjusting the valve clearance, we time the fuel injectors before adjusting the governor gap.

Press A - 25

2

24

No. Your answer is incorrect. After adjusting the exhaust valve clearance, the next step is to time the fuel injectors.

Checking the linkage and throttle movement is the last step of the tune-up.

Press A - 25

2

25

"Time the fuel injectors" is the correct answer.

After timing the fuel injectors, the next step is to _____.

- A. adjust the buffer screw. - 26
- B. check the linkage and throttle movement. - 27
- C. adjust the governor gap. - 28 2

26

No. Your answer is incorrect. After timing the fuel injectors the next step is to adjust the governor gap. Adjusting the buffer screw is one of the last steps.

Press A - 28

2

27

No. Your answer is incorrect. After timing the fuel injectors, the next step is to adjust the governor gap. Checking the linkage and throttle movement is the last step of the tune-up.

Press A - 28

2

32

No. Your answer is incorrect. Adjusting the exhaust valve clearance is the first step of a tune-up. The last three steps are to: adjust the idle speed, adjust the buffer screw, and check the linkage and throttle movement.

Press A

2

33

No. Your answer is incorrect. The last three steps of a tune-up are to: adjust the idle speed, adjust the buffer screw, and check the linkage and throttle movement. "Adjusting the governor gap" is the third step of a tune-up.

Press A

2

28

"Adjust the governor gap" is the correct answer.

Now, after adjusting the governor gap, the next two steps are to _____.

- A. time the fuel injectors and position the injector rack control levers. - 29
- B. position the injector rack control levers and adjust the maximum no-load speed. - 30
- C. position the injector rack control levers and adjust the idle speed. - 31

28

No. Your answer is incorrect. Remember, the fuel injectors are timed before adjusting the governor gap. After adjusting the governor gap, we position the injector rack control levers and adjust the maximum no-load speed.

Press A - 31

30

No. Your answer is incorrect. After adjusting the governor gap we position the injector rack control levers, but we then adjust the maximum no-load speed. We do not adjust the idle speed until the no-load speed is adjusted.

Press A - 31

2

31

"Position the injector rack control levers and adjust the maximum no-load speed" is the correct answer.

The last three steps of a tune-up are to

- A. adjust the idle speed, adjust the buffer screw and check the linkage and throttle movement. - 34
- B. adjust the exhaust valve clearance, adjust the buffer screw and check the linkage and throttle movement. - 32
- C. adjust the idle speed, adjust the governor gap and adjust the buffer screw. - 33

34

"Adjust the idle speed, adjust the buffer screw and check the linkage and throttle movement" is the correct answer.

There are many combinations of engines that can be, and are, equipped with limiting speed mechanical governors (e.g. I-6, V-6, V-8, V-12, and V-16). Since space will not permit individual treatment of each, the step-by-step procedure for tuning the V-16, 71 engine with a limiting speed governor will be covered in this lesson. Although the steps involved in tuning the other engines mentioned are similar, always refer to your maintenance manual and follow the procedures listed there.

Press A - 35

2

← (SEE PAGE 4 FOR FRAMES 32+33) →

35

Step 1 - Performing valve clearance adjustments (cold engine) (see Plate 1 at back of your AM 1-7 Unit):

1. Place governor stop lever in NO-FUEL position.
2. Rotate the crankshaft until the injector follower is fully depressed on the cylinder to be adjusted.
3. Loosen the push rod lock nut.
4. Place a .013" feeler gauge, between the valve stem and the rocker arm. Adjust the push rod to obtain a smooth pull on the feeler gauge.
5. Remove feeler gauge. Hold push rod with a 5/16" wrench and tighten the lock nut with a 1/2" wrench.
6. Recheck the clearance. Use a .011", .013", go-no-go-gauge.
7. Check and adjust the remaining valves in the same manner as outlined above.

Press A - 36

2

36

As we mentioned before, valves must first be adjusted while the engine is _____ with a _____ feeler gauge.

(Choose the right answer to fit the two blanks).

- A. hot, .015" - 37
- B. cold, .013" - 39
- C. cold, .015" - 38

2

37

No. Remember we said that valves must first be adjusted to a cold setting to allow for engine expansion. The answer is a "cold engine with .013" feeler gauge".

Let's move on. Read carefully.

Press A - 39

2

38

No. But you are partially correct. Valves must be adjusted when the engine is cold, but the valves must be set to a gap of .013", not .015".

Press A - 39

2

39

"When the engine is cold with a .013" feeler gauge" is the correct answer.

When rechecking the clearance after it has been adjusted to .013", it is best to _____.

- A. tighten the lock nut half a turn. - 40
- B. rotate the crankshaft. - 41
- C. use a .011", .013", go-no-go-gauge. - 42

2

40

No. You missed the point completely. The lock nut is tightened when you are sure the gap is correct. When rechecking the clearance, if the go-no-go-gauge (.011" to .013") will not work, then you loosen the nut and reset the gap.

Press A - 42

2

41

No. Rotating the crankshaft has nothing to do with rechecking the valve settings. Turning the crankshaft is necessary to put the valve in position so it can be properly set.

Let's move on.

Press A - 42

2

"Use a .011", .013", go-no-go-gauge" is the correct answer.

42

If the first setting was made properly, the .011" feeler gauge should pass freely between the valve stem and the rocker arm, but the .013" part of the gauge will not.

Before adjusting any valves, the governor stop lever should be _____

- A. placed in the full-fuel position. - 43
- B. disconnected from the governor. - 44
- C. placed in the no-fuel position. - 45²

43

No. You are wrong. The governor stop lever must be placed in the no-fuel position before adjusting the valve setting.

Let's move on.

Press A - 45

2

No. You are confused. We said the governor stop lever must be in the no-fuel position before proceeding with adjusting the valves.

44

Let's move on.

Press A - 45

~~45~~

2

45

Correct. After the gaps are set on the valves when the engine is cold, they must be checked again when the engine is at operating temperature (160-185°). At this time use an .008"-.010" go-no-go-gauge. The .008 should pass freely, but the .010 should not. Let's move on to injector timing -- the second step in tuning.

Press A → 47

2

X C → 46

You have answered one or more of the questions in this sequence of material incorrectly.

46

Let's review the material. Read carefully -- think it out before pressing the button.

Press A → 18

2

47

STEP 2 - TIMING THE INJECTORS

Position the rocker arms for checking injector timing. Crank the engine over until the push rod clevis end of the valve rocker arms are up, fully depressing the exhaust valves.

Check you maintenance manual for the proper timing gauge in relation to the type of injector you are timing.

Press A - 48

3

Time each fuel injector (see Plate 2) as outlined below:

48

1. Place the governor speed control lever in the NO-fuel position.
2. Rotate the crankshaft until the exhaust valves are fully depressed on the particular cylinder to be timed.
3. Place the small end of the timing gauge into the hole provided in the injector housing. The flat of the gauge must be toward the injector follower.
4. Loosen the push rod lock nut.

Press A - 49

3

49

5. Turn the push rod and adjust the injector rocker arm until the extended part of the gauge will just pass over the top of the injector follower.
6. Hold the push rod and tighten the lock nut. Check the adjustment and, if necessary, readjust the push rod.
7. Time the remaining injectors, in the same manner as outlined in items 1 through 6.

Before going on to the governor, let's review what's been said about timing injectors.

Press A - 50 3

50

One important factor to consider in timing injectors is to _____

- A. place the governor speed control lever in the FULL-fuel position. - 51
- B. select the proper gauge in relation to type of injector. - 53
- C. adjust the push rod so the gauge will not pass over the injector. - 52

3.

51

No. You are wrong. The governor speed control lever must be placed in the NO-fuel position, just as we placed the governor stop lever in the no-fuel position. The correct answer is "select the proper gauge in relation to type of injector".

Let's move on.

Press A - 53 3

52

No. You aren't paying attention. The gauge must just pass over the top of the injector follower -- then it is adjusted properly. But, before you do any injector timing, you must first select the proper gauge in relation to the type of injector you are working with.

Let's move on -- read carefully!

Press A - 53 3

53

Correct. The proper gauge must be used for each type of injector. Check your manuals for this information.

To properly time an injector, its related exhaust valves must be _____

- A. properly adjusted. - 54
- B. fully closed. - 55
- C. fully depressed. - 56 3

54

You are partly correct. According to the timing sequence, the valves should be adjusted before timing the injectors. However, the answer -- "valves must be fully depressed" is a better answer in this case.

Press A - 56 3

55

No. Think about the answer you chose. When the valves are depressed they are actually in the open position. This is the only position that permits timing of the injector. If the valves were "fully closed", then the injector would be depressed and couldn't be timed.

Press A - 56 3

56

"To properly time an injector, its related exhaust valves must be fully depressed" is the correct answer. The valves on the particular injector to be timed are depressed by turning the crankshaft.

The remaining injectors must be timed _____

- A. according to the firing order of the engine. - 57
- B. after the governor gap is adjusted. - 58
- C. exactly like the first one. - 55

3

DIDACTOR

FILM NO. AM 1-

57

No. You can do it this way, but it is not necessary. Injectors can be timed in any order, just so they are all timed. In other words, they must be timed exactly like the first one.

Press A - 59

3

58

No. All the injectors must be timed and set before the governor is adjusted and after the valves are set.

Press A - 59

3

59

"Exactly like the first one" is the correct answer.

What is the correct position of the timing gauge when timing the fuel injectors?

- A. The flat of the gauge should be toward the injector follower. - 62
- B. The flat of the gauge should be turned away from the injector follower. - 60
- C. There is no set position for the timing gauge. - 61

3

60

No. Your answer is incorrect. The flat of the gauge must be toward the injector follower.

Press A - 62

3

61

No. Your answer is incorrect. There is a definite position for the timing gauge. The flat of the gauge must be toward the injector follower.

Press A - 62

3

62

"The flat of the gauge toward the injector follower" is the correct answer. Now the injector rocker arm is adjusted until the extended part of the gauge will _____ the injector follower.

- A. be .025" above
- B. be a quarter of an inch from > 63
- C. just pass over the top of - 64

3

63

No. Your answer is incorrect. The injector rocker arm is adjusted until the extended part of the gauge will just pass over the top of the injector follower.

Press A - 64

3

63

"Just pass over the top of the injector follower" is the correct answer.

The governor on the 16 V engine is mounted on and driven from the front end of the rear blower. The governor and auxiliary control link housings are mounted between the two blowers.

Prior to adjusting the governor the following steps must be performed.

1. Disconnect the linkage to the governor speed control and the shut down levers.
2. Remove the covers from the governor and auxiliary control link housings.
3. Disconnect the adjustable link from the lever in the auxiliary control link housing and remove the connecting pin.

Press A - 65

3

65

Which of the following is one of the steps to be performed prior to adjusting the governor?

- A. Disconnecting the adjustable link from the lever in the auxiliary control link housing and removing the connecting pin. → 68
- B. Removing the linkage to the governor speed control and the shut down levers. → 66
- C. Disconnecting and removing the lever in the auxiliary control link housing. → 67

3

66

No. Your answer is incorrect. The linkage to the governor speed control and the shut down levers is disconnected, not removed.

Press A - 68

3

67

No. Your answer is incorrect. The lever in the auxiliary control link housing is only disconnected. It is not removed

Press A - 68

3

68

"Disconnecting the adjustable link from the lever in the auxiliary control link housing and removing the connecting pin" is the correct answer.

After removing the connecting pin:

- 4. Install gauge J 21779. It should extend through the lever and fuel rod into the gauge hole in the bottom of the housing. When in place, the auxiliary control link lever will be in mid-travel position, (See Plate III).
- 5. Remove connecting pin from control link lever in governor housing. Install gauge J 21780. Pin extends through connecting link, control lever, and fuel rod. Governor housing dowel pin extends into small hole in gauge. Install a governor cover bolt to lock gauge in place. Governor control link lever will be in mid-travel position and parallel to auxiliary control lever.

Press A - 69

3

69

When the two steps we have just discussed are completed the auxiliary and the governor control link levers will be _____

- A. in opposite travel positions. > 70
- B. in right travel position and parallel.
- C. in mid-travel position and parallel. - 71

3

70

No. Your answer is incorrect. When the gauges have been installed in the auxiliary and governor control link levers the levers will be in mid-travel position and parallel.

Press A - 71

3

71

"In mid-travel position and parallel" is the correct answer. When the gauges are in place, the following steps are taken:

- 6. The length of the adjustable connecting link is adjusted to retain the lever position obtained by the gauges and link installed.
- 7. The gauges are removed and the control link lever pins are reinstalled and the housing covers are replaced.

Press A - 72

3

72

The lever position obtained by the gauges is retained by adjusting the _____

- A. fuel rod. - 73
- B. connecting link. - 75
- C. control lever. - 74

3

73

No. Your answer is incorrect. The fuel rod is not adjustable. The lever position obtained by the gauges is retained by adjusting the connecting link.

Press A - 75

3

No. Your answer is incorrect. The control positions is obtained by the gauges. The position is retained by adjusting the connecting link.

Press A - 75

74

3

75

"Connecting link" is the correct answer. After completing the adjustments we have just discussed, the governor is adjusted.

The four governor adjustments to be made are:

1. governor gap.
2. maximum speed.
3. idle speed.
4. buffer screw.

Press A → 77

XC → 76

3

"Connecting link" is the correct answer. You missed one or more questions in this sequence of material. Let's review it. Read carefully and try to answer all the questions right this time.

Press A → 47

76

3

77

The four governor adjustments to be made are _____

- A. governor gap, medium speed, idle speed, and buffer screw. - 78
- B. governor gap, maximum speed, idle speed, and buffer screw. - 80
- C. governor gap, medium speed, maximum speed and buffer screw. - 78

4

H/A

No. Your answer is incorrect. The four governor adjustments to be made are: governor gap, maximum speed (not medium speed), idle speed, and buffer screw.

Press A - 80

78

4

80

"Governor gap, maximum speed, idle speed, and buffer screw" is the correct answer.

GOVERNOR GAP ADJUSTMENT -- With the engine at operating temperature, set the governor gap as follows, (See Plate IV):

1. With the engine stopped, remove the governor high speed spring retainer cover.
2. Back out the buffer screw until it extends approximately 5/8" from the lock nut.
3. Start the engine. Adjust the idle screw to obtain the desired idle speed.
4. Stop the engine. Remove the governor cover and lever assembly.
5. Start the engine and run between 800 and 1000 rpm.

Press A - 81

4

GOVERNOR GAP ADJUSTMENT (cont'd.)

6. With the engine operating between 800 and 1000 rpm, set the gap between the low speed spring cap and the high speed spring plunger at .0015".
7. Hold the gap adjusting screw and tighten the lock nut.
8. Recheck the governor gap (800 to 1000 rpm), by placing a screw driver between the gap adjusting screw and the governor housing, and manually forcing the gap closed. If the setting is correct, the .0015" movement can be seen. To see the gap better, place a drop of oil into the gap.
9. Stop the engine and reinstall the governor cover and lever assembly.

Press A - 82

4

82

Before going on to positioning the injector rack control levers, let's be sure you understand the proper sequence of setting the governor gap.

The buffer screw must be backed _____.

- A. all the way out from the lock nut.
- B. out 5 and 1/8 inches from the lock nut. >83
- C. out 5/8 inches from the lock nut. 84

80

No. You are not reading very carefully. The correct answer was 5/8" from the lock nut. Answer your questions carefully.

Let's move on.

Press A - 84

84

Correct.

After the idle speed has been set, the engine is started again to _____.

- A. reach operating temperature. -85
- B. reach an rpm between 800 and 1000. -87
- C. recheck the governor gap. -86

85

No. The engine should be at operating temperature before starting the governor adjustment. The correct answer is to reach an rpm between 800 and 1000.

Let's move on.

Press A - 87

86

No. You haven't set the governor gap yet. The correct answer is to reach an rpm between 800 and 1000 so the governor gap can be set.

Let's move on.

Press A - 87

87

Correct. Let's move on to positioning the injector rack control levers.

Cylinders are numbered starting at the front of the engine on each cylinder bank, (See Plate V). Adjust the No. 4R (right) injector rack control lever first to establish a guide for adjusting the remaining right bank injector rack control levers.

Proceed as follows:

1. Adjust the idle speed adjusting screw until 1/2" of the threads (12-14 threads) project from the lock nut when the nut is against the high speed plunger.
2. Loosen the buffer screw lock nut and back out the buffer screw.

Press A - 88

88

Positioning the Injector Rack Control Levers (cont'd.)

3. Remove all valve rocker covers.
4. Loosen all the inner and outer injector rack control lever adjusting screws on both cylinder banks. Be sure all the injector rack control levers are free on the injector control tubes.
5. Check for any bind in the governor to control tube linkage by moving the linkage through its full range of travel.
6. Remove the clevis pins which attach the right rear bank and both left bank fuel rods to the injector control tube levers.
7. Move the governor speed control lever to the maximum speed position; hold the stop lever in the run position with light finger pressure.

Press A - 88

89

Positioning the Injector Rack Control Levers (cont'd.)

8. Turn the inner adjusting screw of No. 4R rack down until a step-up in effort is noted. This will place No. 4R rack in Full-fuel position. Turn down the outer screw until it bottoms. Then alternately tighten both screws. Do not set too tight.
9. To be sure you have the correct setting on No. 4R lever, press down on the injector rack with a screw driver (stop lever in RUN position). If a "bounce" is noted, the setting is correct. Readjust, if necessary, to get a "bounce".

The importance of this step is to be sure _____.

- A. the injector rack cannot become loose. -90
- B. that maximum fuel position can be obtained. -92
- C. the linkage works properly. -91

90

91

No. The injector rack is not likely to come loose. The purpose of getting a "bounce" is to make certain the operator can get maximum fuel when he wants it. A loose and sloppy adjustment here would prevent maximum performance of the engine.

No. This is important to watch though, because if the linkage is binding, the maximum fuel position cannot be reached. The idea of getting the "bounce" is to make sure that maximum fuel is obtainable.

Press A - 92

Press A - 92

4

4

Correct. Obtaining a good "bounce" after adjusting will permit maximum performance of the engine.

92

Let's move on to the next step.

- 10. To set No. 5R (right bank) remove the clevis pin from the right front bank fuel rod and insert the pin connecting the right rear bank fuel control rod.
- 11. Proceed exactly as you did before, obtaining the proper "bounce".
- 12. Repeat the steps until "bounce" is obtained on No. 4R, 5R, 4L, and 5L injector racks.

Press A - 93

- 13. To adjust the remaining control levers, hold the No. 4R injector rack in the full-fuel position by means of the lever on the end of the control tube assembly. Turn down the inner adjusting screw of No. 3R until the full-fuel position is reached. Turn the outer screw down until it bottoms. Be sure to recheck No. 4R for "bounce" and keep checking back for bounce as the other injectors are set.
- 14. Adjust the remaining injector rack control levers on the right rear, left front and left rear cylinder banks exactly like the previous procedure

After all the injectors are set and "bounce" is obtained on all, go to the right front bank and repeat the procedure.

Press A - 94

- 15. Install the four-fuel rod to control tube lever clevis pins and check the adjustment of the injector rack control levers.
- 16. Turn the idle speed adjusting screw until it projects 3/16" from the lock nut to permit starting the engine.

Before going on with adjusting the idle speed, let's review to see if we have the last sequence of material well in mind. When setting No. 4R injector rack to the governor

- A. care should be used to avoid setting racks too tight causing fuel rod to bind.
- B. the idle speed should be preset to 750 rpm.
- C. the throttle control lever should be held in the idle position.

Press A - 97

No. Remember we talked about the linkage being free to move. If the racks are set too tight, the rod might bind and bend if someone tried to force it.

Let's move on. Read carefully.

Press A - 97

No. You are incorrect. The throttle control lever should be held in the maximum fuel position. The correct answer to this question is that care should be taken to avoid setting the racks too tight -- which might cause the fuel rod to bind.

96

97

Let's move on.

Press A - 97

Correct.

Cylinders are numbered starting at the front of the engine on each cylinder bank. On the 16V series it is recommended that the No. ___ injector rack control lever be adjusted to establish a ___ for adjusting the remaining ___ bank levers. (Choose the set of words that best fit the three blanks).

- A. 3R, guide, left
- B. 5R, sequence, right
- C. 4R, guide, right

98

99

Correct.

When we talk of getting a "bounce" while adjusting the control rod to injector rack we mean _____.

- A. the rack will return to its original position when the pressure is lifted.
- B. as the outer adjusting screw is bottomed, the fuel rack will give slightly.
- C. the movement of the clevis pin in the control linkage.

-101
>100

4

No. You are not reading very carefully. There is a definite sequence for tuning the 16V engine. It is recommended that you start with No. 4R on the right rear bank and use this one as a guide for setting the other injector racks in the bank.

Press A - 99

4

100

101

No. Remember we said the bounce is obtained by applying pressure with a screw driver to the injector rack, if the U-shaped lever returns to its original position, then the adjustment has been made correctly.

Press A -101

4

Correct. Bounce is very important in getting a good tight tune-up. The reason to keep rechecking the No. 1 injector rack as the remaining racks are set is to be sure the _____.

- A. first one (guide) has not been disturbed.
- B. injector control tube is not binding.
- C. inner adjusting screws are all tight.

4

102

103

No. The only reason to keep rechecking the guide is to make sure the "bounce" has not been disturbed when the other inner and outer screws are being tightened.

Press A -103

4

OK. Your answer is correct. Now, let's discuss **ADJUSTING THE IDLE SPEED.**

1. With the engine running at normal operating temperature and the buffer screw backed out, turn the idle speed adjusting screw until the engine idles at the recommended speed. Check engine specifications for recommended idle speed.

NOTE: It may be necessary at this time to use the buffer screw to eliminate engine roll. After the idle speed is established, back out the buffer screw to the previous setting of 5/8".

2. Hold the idle screw and tighten the lock nut.
3. Install the high speed spring retainer cover.

Press A -104

4

104

105

ADJUSTING MAXIMUM NO-LOAD ENGINE SPEED

NOTE: Be sure the buffer screw projects 5/8" from the lock nut to prevent interference while adjusting the maximum no-load speed.

1. Loosen the spring retainer lock nut and back off the high speed spring retainer approximately five turns.
2. With engine running at operating temperature and with no-load, place the speed control lever in the maximum speed position. Turn the high speed spring retainer until the engine is operating at the recommended no-load speed.
3. Hold the high speed spring retainer and tighten the lock nut.

Press A -105

4

When adjusting for maximum no-load engine speed the buffer screw should be _____.

- A. backed out as far as it will go.
- B. backed out to 5/8".
- C. in as far as it will go.

4

DIDACTOR

FILM NO. AM 1-

106

No. Your answer is incorrect. When adjusting for maximum no-load engine speed the buffer screw should be backed out to 5/8". Otherwise, it would interfere with the adjustments.

Press A -107

4

"Backed out to 5/8 inch" is the correct answer.

ADJUSTING THE BUFFER SCREW -- With the idle speed set, the buffer screw may be adjusted as follows:

1. With the engine running at normal operating temperature, turn the buffer screw in so that it contacts the differential lever as lightly as possible and still eliminates the engine roll.

NOTE: Do not increase the engine idle speed more than 15 rpm with the buffer screw.

2. Hold the buffer screw and tighten the lock nut.
3. Recheck the maximum no-load speed. If it has increased more than 25 rpm, back off the buffer screw until the increase is less than 25 rpm.

Press A -108

4

108

Before completing this lesson, let's discuss some engine troubles that may occur due to a faulty tune-up.

When the engine is running uneven, or frequent stalling is occurring, the problem may be _____.

- A. binding of the governor-to-injector operating linkage.
- B. insufficient air.
- C. low oil pressure.

-110 4

No. More often it will be governor "hunting". This could be caused by binding of the linkage between the governor and injector.

Let's move on.

Press A -111

10

110

No. Low oil pressure more often causes a rise in temperature. Uneven running or frequent stalling is probably being caused by the governor "hunting". This situation would call for checking the governor-to-injector linkage for binding.

Press A -111

4

Correct. There may be a condition known as governor "hunting" causing the uneven running. This could be a result of faulty tune-up. If the situation persists after a good tune-up, check the injector spray tips, they may be leaking.

When a loss of power is indicated, the problem may be an improperly timed gear train. This could cause _____.

- A. binding of the governor-to-injector linkage.
- B. the camshaft running at a much lower rpm than the gear train.
- C. the valves and injector being actuated at the wrong time.

-112
-113
-114

112

No. Unless the linkage was binding before, the fact that the gear train was out of time would not cause new binding. The correct answer was: the valves and injectors would be actuating at the wrong time.

Press A -114

4

No. The gear train being out of time would not alter the rpm of the camshaft; it would only prevent the camshaft from turning at the proper time.

Press A -114

4

DIDACTOR

FILM NO. AM 1-70

115

114

Correct.

You have now completed the program on the engine tune-up of the Detroit Diesel Engine. Congratulations !!

Press Rewind

XC → 145

"The valves and injector being actuated at the wrong time" is the correct answer.

You have answered one or more of the questions incorrectly. Let's review the material. Read carefully and try to answer all the question correctly.

Press A → 80

4

**ENGINE TUNE-UP IS
NECESSARY WHEN:**

A new engine is installed.

A new engine has run 1000 hours.

Performance is unsatisfactory.

An engine has just been overhauled.

The cylinder head assembly is new.

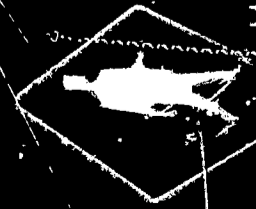

HUMAN
ENGINEERING
INSTITUTE

1978

For best
the follo

1. Wall

2. Injec

3. Gove

4. Inje

5. Fin

HUMAN
ENGINEERING
INSTITUTE

1117 ③

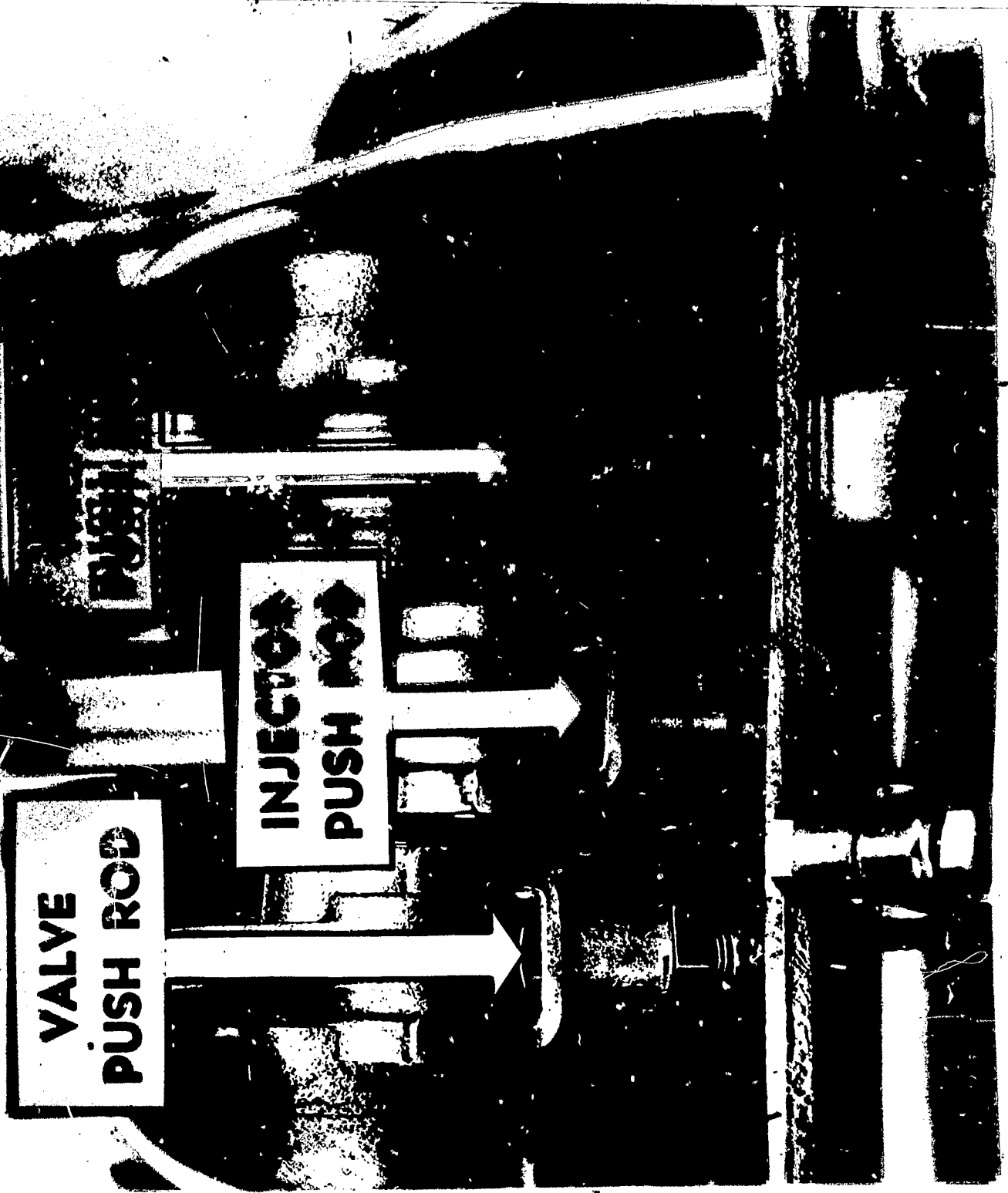

VALVE
PUSH ROD

INJECTOR
PUSH ROD

PUSH
ROD

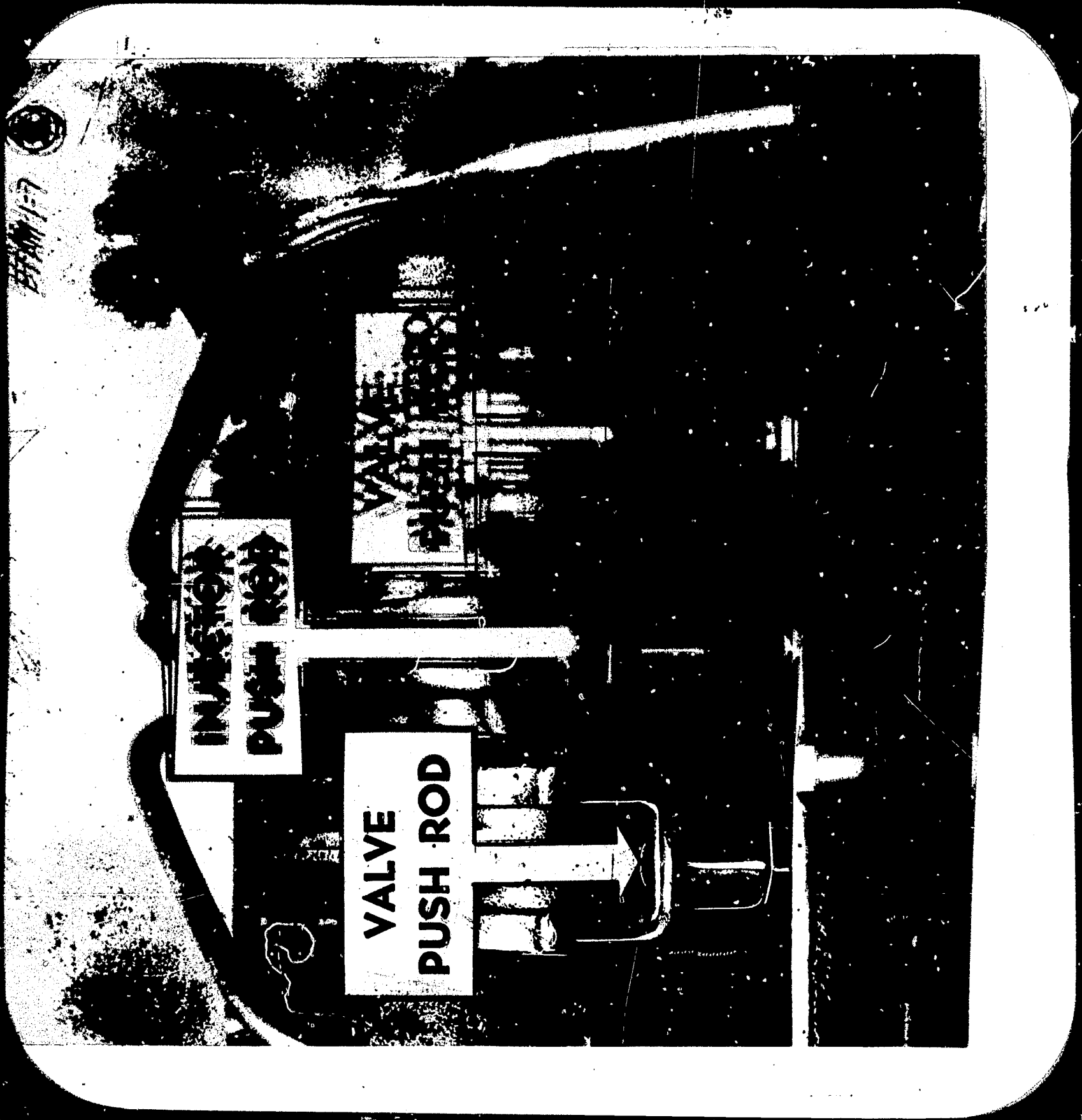

HUMAN
ENGINEERING
INSTITUTE

5

1/17

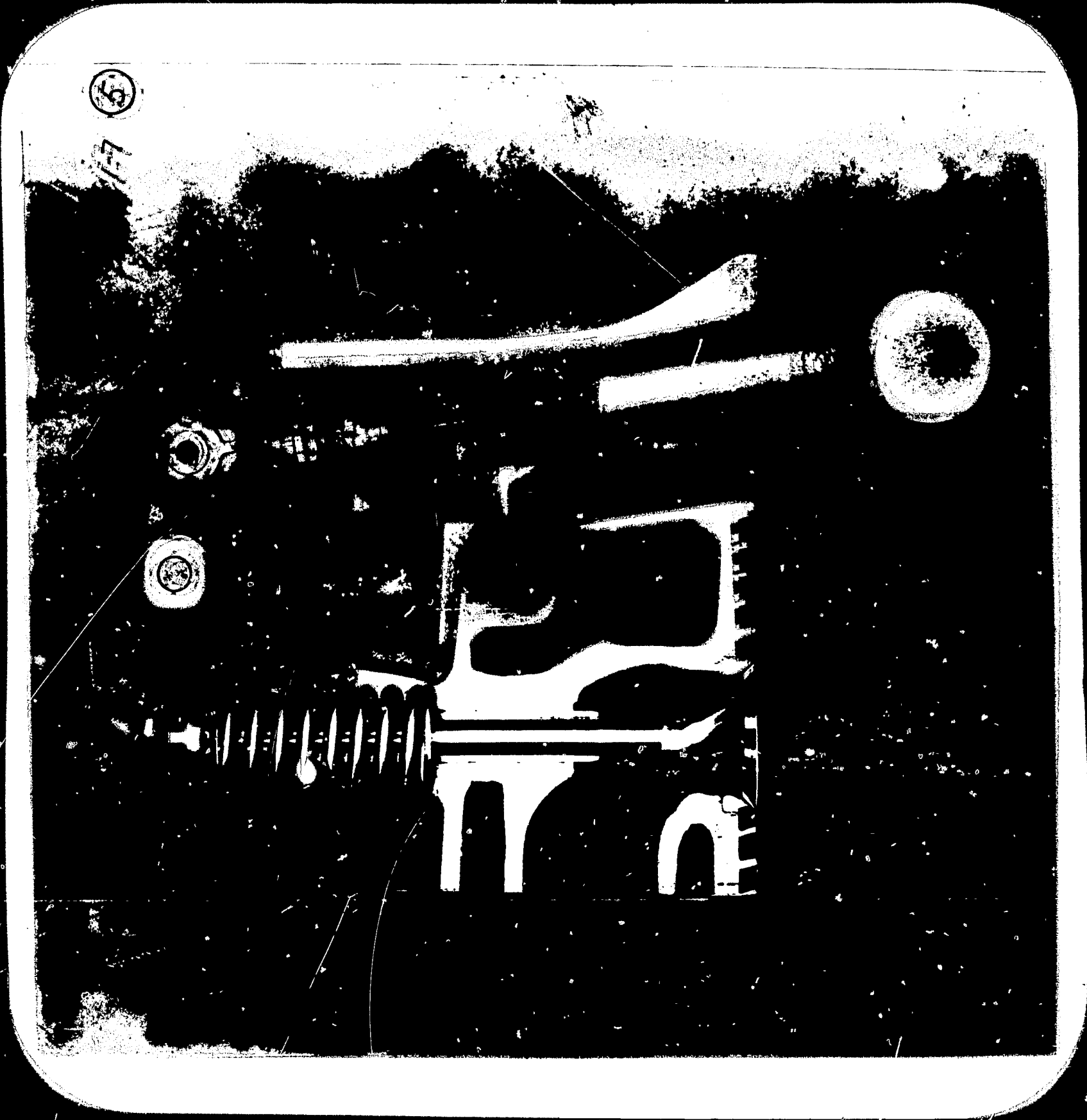



PTM 17



HUMAN
ENGINEERING
INSTITUTE

131 Carnegie Ave
Pittsburgh, Ohio 44115

... DEVELOPMENT • SUPERVISOR •
PERSONNEL TESTING •

⑦

P-FAM 17



GOVERNOR SPEED
CONTROL LEVER

SPRING RETAINER
LOCK NUT

GOVERNOR SPEED
RETAINER

PIRAM
1-7
©

Cleveland, Ohio 44112
3347 Carnegie Ave

INSTITUTE
ENGINEERING
HUMAN

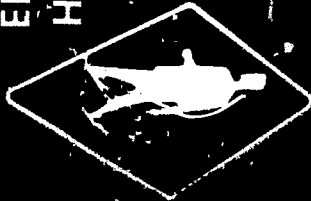



OUTER SCREW

INSTRUCTOR'S GUIDE

Title of Unit: Engine Tune-Up --
Detroit Diesel Engine

Code: PTAM 1-7

10/11/65

FIRST: Be sure all questions have been answered that students might have on home study units.

OBJECTIVES: By the end of class, each student should know:

1. When to tune-up an engine.
 2. How to identify a governor (D. W. L. S. etc.)
 3. When to make adjustments on a cold engine vs. an engine at operating temperature.
 4. Have a working knowledge of the tune-up sequence.
 5. The importance of a proper valve clearance and adjustment.
 - A. Why a valve setting is made on a cold engine -- then made again on an engine at operating temperature.
 - B. The correct operating temperature.
 6. The differences in procedure when performing valve adjustment on a four-valve head vs. a two-valve head.
 7. The proper procedure for timing injectors.
 8. The importance of using the proper injector timing gauge.
 9. The purpose of a limiting speed governor.
 - A. Steps required to adjust a L. S. governor on an In-line engine.
 - B. The differences between a S. W. and D. W. governor on the In-line
 10. How to adjust the injector rack control levers.
 11. How to adjust the maximum no-load speed.
 12. How to adjust the idle speed.
 13. How to adjust the buffer screw.
 14. How to adjust the governor and injector rack control levers on V-series engine.
 15. How the governor adjustments differs between the 6V, 8V, 12V and the 16V series.
 16. Some troubleshooting tips to keep in mind.
-

LEARNING AIDS suggested:

VUE CELLS:

PTAM 1-7 (1)	(When an engine tune-up is necessary)
PTAM 1-7 (2)	(Tune-up sequence)
PTAM 1-8 (5)	(Valve and injector operating mechanism)
PTAM 1-7 (3)	(Push rod position - injector timing)
PTAM 1-7 (4)	(Push rod position - valve clearance)
PTAM 1-7 (5)	(Valve operating mechanism - side view)
PTAM 1-6 (1)	(Limiting speed mechanical governor - cutaway)
PTAM 1-7 (6)	(Limiting speed mechanical governor - top view)
PTAM 1-7 (7)	(Limiting speed mechanical governor - V-16)
PTAM 1-7 (8)	(Max. no-load speed adjustment)
PTAM 1-7 (9)	(Engine idle speed adjustment)
PTAM 1-7 (10)	(Buffer screw adjustment)

Maintenance Manuals:

- GM - In-line and Vee series
 - GM - tune-up, troubleshooting and maintenance information.
-

Film Strips:

- (1) Engine tune-up -- In-line 71 series -- limiting speed governor
(GM #25SE26)
- (2) Engine tune-up -- V-71 series -- limiting speed governor
(GM #25SE23)

NOTE: If available use booklets accompanying the above film strips entitled "Meeting Leader's Guide".

Cutaways: Governor

QUESTIONS FOR DISCUSSION AND GROUP PARTICIPATION:

1. When is an engine tune-up necessary?
2. Are governors labeled?
3. What adjustments are made when the engine is cold?
4. What is meant by valve clearance?
5. What can result from improper valve clearance?
6. What is a two-valve head?
7. Is the position of the crankshaft important when timing injectors?
8. Is there one timing gauge for all injectors?
9. Do the V-series engines have single weight governors?
10. Why is the injector rack control adjustment important?
11. Why is it necessary to hold the speed control lever on the governor when adjusting the injector control tube?
12. What can happen if the injectors are not adjusted to a full-fuel position?