

R E P O R T R E S U M E S

ED 014 421

SE 002 770

MODERN TEACHING AIDS FOR COLLEGE CHEMISTRY--PORTABLE VIDEO RECORDING SYSTEMS, NEW USES FOR FILMS, COMPUTER ASSISTED INSTRUCTION.

BY- LIPPINCOTT, W.T. BRATED, R.C.

ADVISORY COUNCIL ON COLL. CHEMISTRY

REPORT NUMBER ACCC-TAC-SER-PUB-18

PUB DATE DEC 66

EDRS PRICE MF-\$0.25 HC-\$2.24 54P.

DESCRIPTORS- *AUDIOVISUAL AIDS, *COLLEGE SCIENCE, *CHEMISTRY, *CONFERENCE REPORTS, *INSTRUCTION, BIBLIOGRAPHIES, COMPUTER ASSISTED INSTRUCTION, EDUCATIONAL TELEVISION, FILMS, PROJECTION EQUIPMENT, TELEVISION, ADVISORY COUNCIL ON COLLEGE CHEMISTRY, STANFORD UNIVERSITY

RESULTS OF A 1966 CONFERENCE ON TEACHING AIDS FOR COLLEGE CHEMISTRY ARE SUMMARIZED IN THIS REPORT. MAJOR SECTIONS OF THE REPORT ARE (1) PORTABLE TELEVISION TAPE RECORDING SYSTEMS, (2) FILMS AND FILM LOOPS, AND (3) COMPUTER-ASSISTED INSTRUCTION. A SUMMARY OF PRESENT AND POTENTIAL INSTRUCTIONAL APPLICATIONS FOR EACH MAJOR TYPE OF MEDIA IS PRESENTED. INFORMATION ABOUT THE PURCHASE, USE, AND MAINTENANCE OF EQUIPMENT IS PROVIDED. THE SECTION ON EDUCATIONAL TELEVISION CONTAINS INFORMATION ABOUT CLOSED CIRCUIT TELEVISION EQUIPMENT AND THE BASIC PRINCIPLES OF VIDEO TAPE RECORDING. FILM LECTURE-EXPERIMENTS, SINGLE CONCEPT FILMS, FILMS THAT ILLUSTRATE THE STRUCTURE AND OPERATION OF INSTRUMENTS, FILMS FOR OUT-OF-CLASS VIEWING, FILMS COORDINATED WITH OTHER TYPES OF MEDIA, ANCILLARY MATERIALS FOR FILMS AND TAPES, AND FILMING TECHNIQUES ARE CONSIDERED IN THE SECTION ON EDUCATIONAL FILMS. THE SECTION CONCERNING EDUCATION FILMS ALSO INCLUDES A COMPREHENSIVE GUIDE TO SOURCES OF VISUAL AIDS, A DESCRIPTION OF THE FEATURES, SOURCES, AND COSTS OF VARIOUS TYPES OF PROJECTION EQUIPMENT, AND A DISCUSSION OF PROJECTION SCREENS. THE SECTION ON COMPUTER-ASSISTED INSTRUCTION INCLUDES A GENERAL DESCRIPTION OF NECESSARY EQUIPMENT, AN EXPLANATION OF A TYPICAL PROGRAM, AND THE APPLICATION OF COMPUTER-ASSISTED INSTRUCTION TO THE TEACHING OF CHEMISTRY. REFERENCES FOR EDUCATIONAL TELEVISION AND COMPUTER-ASSISTED INSTRUCTION ARE APPENDED. THIS DOCUMENT IS ALSO AVAILABLE FROM THE ADVISORY COUNCIL ON COLLEGE CHEMISTRY, DEPARTMENT OF CHEMISTRY, STANFORD UNIVERSITY, STANFORD, CALIFORNIA 94305. (AG)

ED014421

**MODERN TEACHING AIDS
FOR COLLEGE CHEMISTRY**

**A Project Of The
TEACHING AIDS COMMITTEE
of the
ADVISORY COUNCIL
ON COLLEGE CHEMISTRY**

SE 002 770

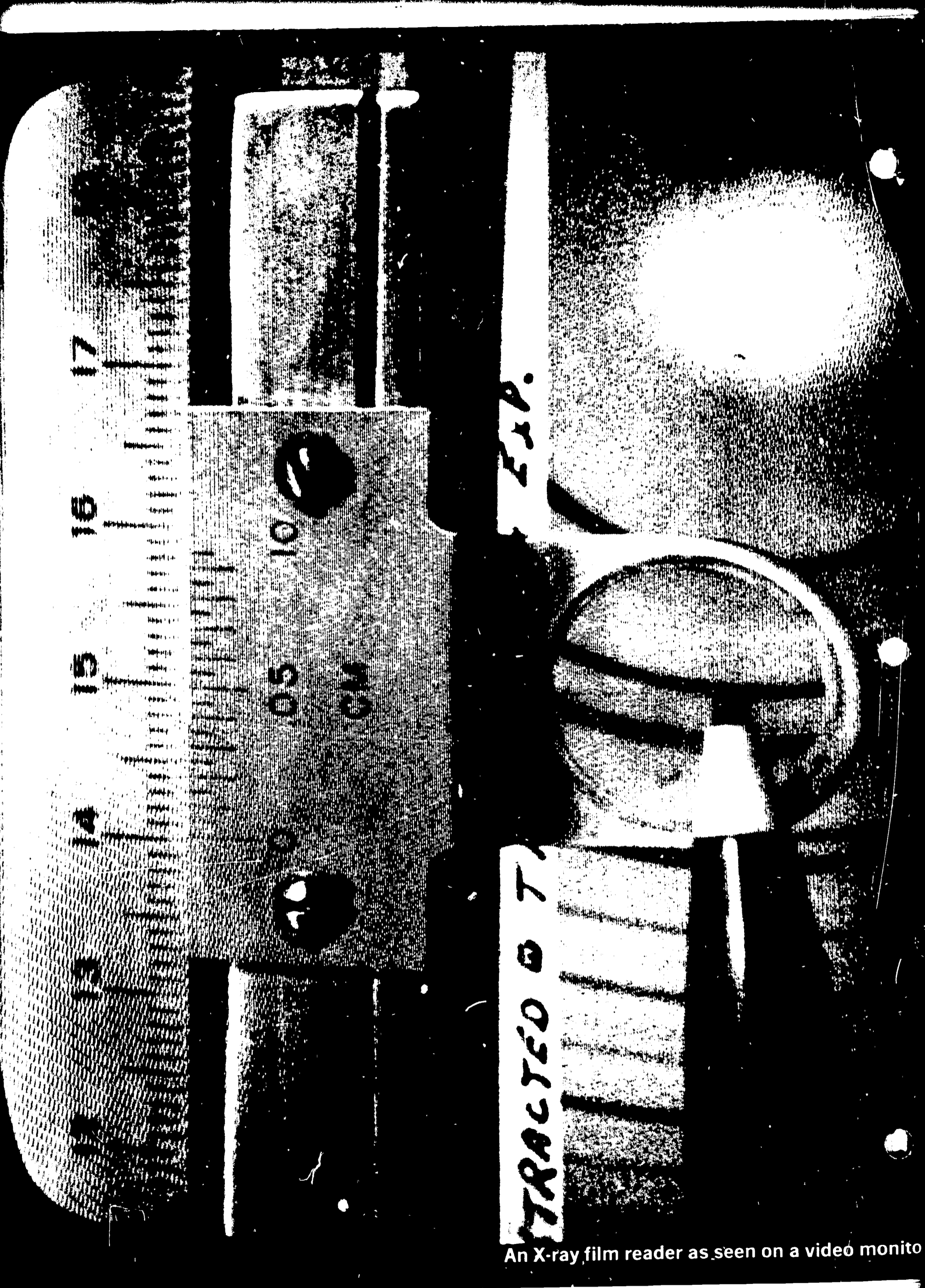

L.P.

TRACED 07

An X-ray film reader as seen on a video monitor

THIS DOCUMENT HAS BEEN REPRODUCED EXACTLY AS RECEIVED FROM THE
PERSON OR ORGANIZATION ORIGINATING IT. POINTS OF VIEW OR OPINIONS
STATED DO NOT NECESSARILY REPRESENT OFFICIAL OFFICE OF EDUCATION
POSITION OR POLICY

MODERN TEACHING AIDS FOR COLLEGE CHEMISTRY

PORTABLE VIDEO RECORDING SYSTEMS

NEW USES FOR FILMS

COMPUTER ASSISTED INSTRUCTION

**A Project Of The
TEACHING AIDS COMMITTEE**

of the

**ADVISORY COUNCIL
ON COLLEGE CHEMISTRY**

Contributors: W. R. Barnard, Ohio State University; R. C. Brasted, University of Minnesota; W. B. Cook, Advisory Council on College Chemistry; E. L. Haenisch, Wabash College; R. N. Hammer, Michigan State University; J. J. Lagowski, University of Texas; W. T. Lippincott, Ohio State University; W. T. Mooney, El Camino College; B. E. Norcross, State College, N. Y. at Binghamton; W. H. Slabaugh, Oregon State University; J. A. Young, King's College.

SERIAL PUBLICATION NUMBER 18

DECEMBER 1966

ADVISORY COUNCIL on COLLEGE CHEMISTRY

Department of Chemistry, Stanford University, Stanford, California 94305

The Advisory Council on College Chemistry is an independent group of chemists interested in how improvement and innovation in undergraduate chemistry curricula and instruction can be effectively implemented at the national level. The Council collects and disseminates information through the activities of standing committees on Freshman Chemistry, Curricula and Advanced Courses, Teaching Aids, Teacher Development, Science for Non-Science Majors, Junior Colleges, Resource Papers, and an Editorial Committee. Additional *ad hoc* groups act as necessary. The Council hopes to provide leadership and stimulus for imaginative projects on the part of individual chemists.

The Council is one of a group of collegiate commissions supported by grants from the National Science Foundation. The Council cooperates in intercommission activities.

OFFICERS and STAFF

*L. C. King, *Chairman*; *W. H. Eberhardt, *Vice-Chairman*; W. B. Cook, *Executive Director*; A. F. Isbell, *Senior Staff Associate*. *COUNCIL MEMBERS: *Robbin C. Anderson '67, *The University of Texas*; Gordon M. Barrow, '68, *Case Institute of Technology*; O. Theodore Benfey, '68, *Earlham College*; Henry A. Bent, '69, *University of Minnesota*; *Robert C. Brasted, '69, *University of Minnesota*; Melvin Calvin, '67, *University of California*; J. Arthur Campbell, '68, *Harvey Mudd College*; *William H. Eberhardt, '68, *Georgia Institute of Technology*; Harry B. Gray, '69, *California Institute of Technology*; *Edward L. Haensch, '67, *Wabash College*; *David N. Hume, '69, *Massachusetts Institute of Technology*; Emil T. Kaiser, '69, *The University of Chicago*; Michael Kasha, '69, *Florida State*

*Executive Committee.

University; *William F. Kieffer, '67, *The College of Wooster*; *L. Carroll King, '69, *Northwestern University*; *Richard J. Kokes, '67, *The Johns Hopkins University*; Elwin M. Larsen, '68, *University of Wisconsin*; *W. T. Lippincott, '67, *The Ohio State University*; Howard V. Malmstadt, '69, *University of Illinois*; *William T. Mooney, Jr., '69, *El Camino College*; Leonard K. Nash, '67, *Harvard University*; Melvin S. Newman, '68, *The Ohio State University*; Charles C. Price, '69, *University of Pennsylvania*; Charles N. Reilley, '68, *University of North Carolina*; Frederick W. Schmitz, '67, *New York City Community College*; Glenn T. Seaborg, '67, *Atomic Energy Commission*; Robert I. Walter, '69, *Haverford College*; Peter E. Yankwich, '68, *University of Illinois*; Jay A. Young, '68, *Kings College*.

PREFACE

This report is the result of a writing conference held at Stanford University in late July and early August of 1966. It was conceived at a conference on new teaching aids sponsored by the Advisory Council and held at the MIT Science Teaching Center in March 1966. At that time, it became apparent that very recent technological developments in the audio-visuals industry had made available relatively inexpensive, especially reliable, and uncommonly easy to operate film projectors, portable video tape recorders and other hardware, all of which appeared to offer unusual potential for improving college chemistry instruction. Because most participants at the MIT conference were unfamiliar with the new hardware and its potential, it was suggested that a rather detailed summary of these new developments and of their applications to chemistry instruction be prepared and made available to college chemistry teachers.

Mr. Robert Barnard, then at Montana State University and now at Ohio State University, assumed the heavy burden of gathering information on films, film hardware, and on video tape systems. He, in collaboration with Professor E. L. Haenisch, W. H. Slabaugh and W. T. Mooney, is largely responsible for the section of the report on films. Professors W. B. Cook, R. N. Hammer, W. T. Lippincott, and B. E. Norcross assembled and wrote the section on video systems. Professors J. J. Lagowski, and J. A. Young contributed the section on computer-assisted instruction. Professors W. T. Lippincott and R. C. Brasted read and edited the entire report.

The members of the writing team are indebted to the consultants, Mr. John Flory of Eastman-Kodak, Mr. Don Horstkorta of the

SONY Corporation, Mr. David Thomas of Reeves Engineering and Mr. William Justus of the Telecommunications Center at Ohio State University, for their invaluable advice during and after the writing conference. Acknowledgment also is made to Mrs. William B. Cook and her staff at AC₃ headquarters and to Mrs. Sue Adler of Ohio State University for their considerable assistance in the preparation of the manuscript. Photographs of television monitors were made by Mr. Dave Eelby of the Teaching Aids Laboratory at Ohio State University.

The Teaching Aids Committee will continue in its efforts to develop materials to exploit the capabilities of new audio-visual techniques. Every effort will be made to bring these new capabilities before the chemical education community and, when possible, to distribute samples of the developed materials to interested college chemistry teachers. We also are interested in learning of activities or programs which employ new teaching aids or techniques so we can facilitate the spread of novel ideas and applications. In addition, we encourage inquiries on these matters and will appreciate assistance on our several projects designed to improve college chemistry instruction by the effective use of audio-visual aids.

The Teaching Aids Committee of AC₃

J. A. CAMPBELL

W. B. COOK

E. L. HAENISCH

W. F. KIEFFER

H. V. MALMSTADT

J. A. YOUNG

W. T. LIPPINCOTT, *Chairman*

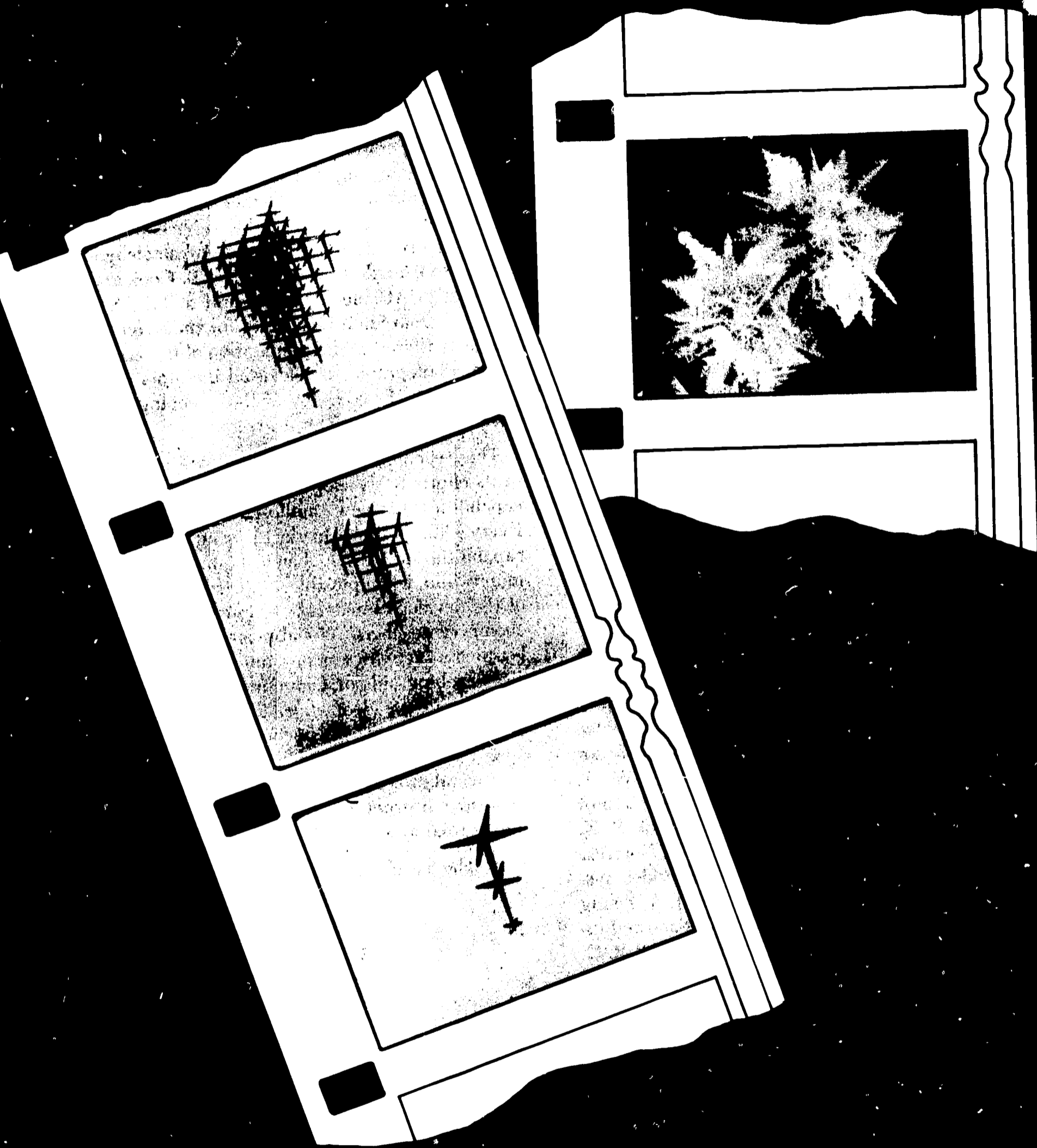

Growing zinc dendrites with accompanying animated growth sequence. Photographed from color film, "Metal Crystals in Action" produced by American Society for Metals.

TABLE OF CONTENTS

INTRODUCTION	1
Portable Video Tape Recording Systems	5
TV in Chemistry Instruction	5
New Capabilities and New Uses	5
Preparation of Video Tapes	7
Closed Circuit Television Systems	7
The basic video recording installation	9
Expansion of the basic video recording installation	9
Distribution of television signals	11
Lighting	11
Maintenance	11
Video tape	11
Large screen television projection	12
Color television	12
Principles of Video Tape Recording	13
Role of TV Cameras and Accessories	13
Video Tape Recording	13
Video recorder heads	14
Rotating recorder heads	14
Image sharpness in video recordings	14
Editing, Interchangeability and Standards	15
Films and Film Loops	17
New Uses for Films	17
Some specific examples	19
Auxiliary materials for films and tapes	23
Sources of Chemistry Films	24
Film directories	24
Other film sources	25
Equipment: Its Availability and Uses	26
Film types	26
Projectors	27
Sound characteristics of film	29
Film costs	31
Cameras and lenses	31
Still projection systems	31
Utilization of Projected Materials	32
Projection screens	32
Computer-Assisted Instruction	37
Equipment	37
Programs	38
The Use of Computer-Assisted Instruction in Chemistry	41
Laboratory	41
Tutorial assistance	42
Evaluation of student ability and progress	42
Incorporation of other material	42
Summary	43
References and Footnotes	45

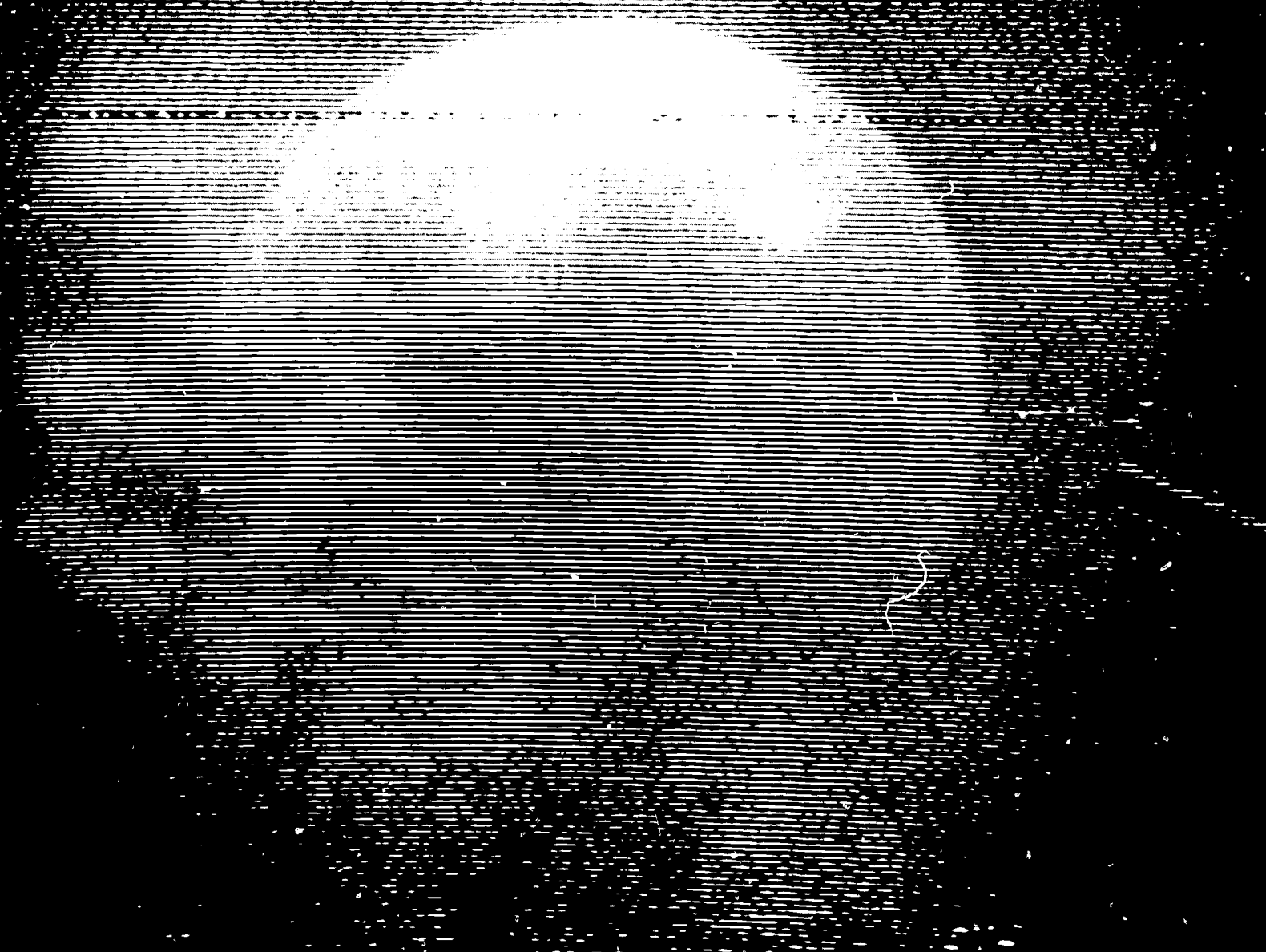

Stop-motion video tape pictures of an exploding balloon

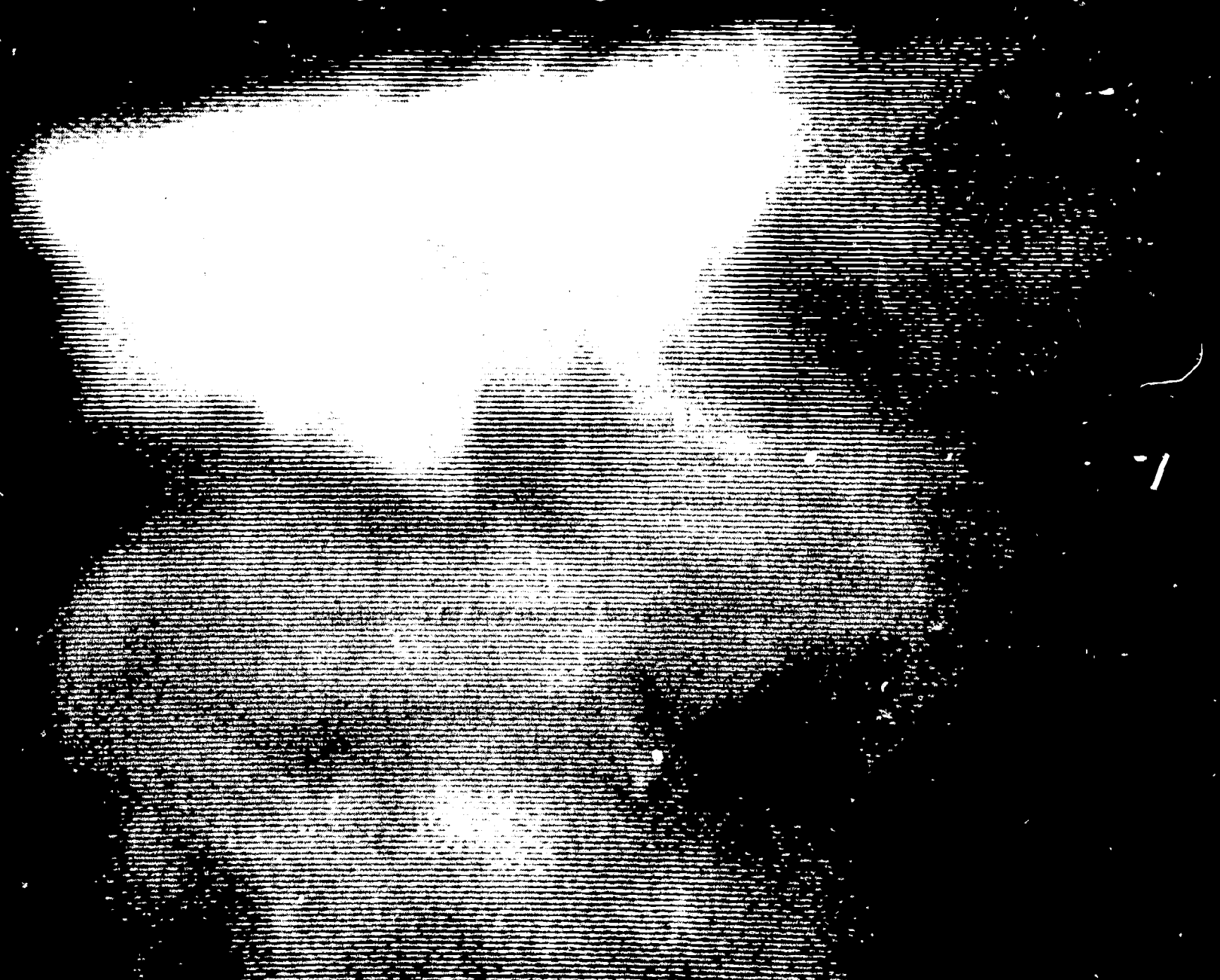



INTRODUCTION

The knowledge explosion, which for chemistry at this writing brings a doubling of the total amount of published chemical information every seven and a half years, and which provides a continuous, exciting and enriching challenge for chemistry teachers who remain intrigued with their subject, has created the conditions for a major breakthrough in the art and science of teaching.

Last year a Nobel Laureate sitting in his office in California lectured to a class of chemistry students in Montana. As he wrote and drew formulas on a pad in front of him, the students read his words from a projection screen at the front of their classroom. When a student had a question, he pressed a button and the professor, receiving the signal, immediately acknowledged it, listened to the question and responded. Both the students and the professor were thrilled by the experience. Needless to say the teaching-learning interaction proceeded with unusual efficiency.

Earlier this year an engineer demonstrating newly developed television tape equipment obtained permission to tape a chemistry class in session. During the lecture the instructor ignited a balloon containing hydrogen. After class some students asked to see a replay of that portion of the tape. The engineer while slowing down the motion suddenly stopped it on one frame and there, in perhaps the first stop-action from tape replay in a chemistry classroom, was the image of the balloon — one side a bursting mass of flames, the other side still intact.

A chemist at Bell Telephone Laboratories, teaching other chemists some uses of computers, shows how the instrument can be programmed to reproduce the nuclear magnetic resonance spectra of some cycloalkanes. He notes, however, that the spectrum of one strained compound does not correspond to the computer-generated spectrum. Suspecting that perhaps the HCH bond angle is increased in this substance, he asks the computer to give him the nmr spectrum for this compound if, while all other parameters remain constant, a slight change is made in the bond angle. The compu-

ter responds in seconds with a new spectrum which is a close fit but not an exact fit. Again the chemist increases the bond angle in the computer program and requests still another spectrum. This time the fit is even closer.

Without arguing the pros and cons of whether changes in parameters other than the bond angle might give a similar fit for the computer generated nmr spectrum, the profound message here is that the classroom teacher now has available to him computing capability having incredible memory and able to display its results in numerical or in graphical form or even as a moving image.

It is mechanical developments such as the *Blackboard-by-Wire*, the *Data Phone with Voice Writer*, the portable television tape recorder, the cartridge-loading movie projector, the shared-time computer with terminals located in classroom which have created the conditions for revolutionary innovation in teaching and learning processes. The examples cited above are but three of many that could be given.

Within six months, and at a cost to his institution of not much more than his own yearly salary, a chemistry instructor could have at his disposal:

- The capability to insert into his lecture with the push of a button a 30 second or longer segment of film which illustrates precisely the point under discussion, in color, in motion, and accentuated by pertinent filmed techniques such as close up, time lapse, slow motion, or animation. Such film segments could be reversed, re-run, and any number could be shown in a lecture — all of this via push button control in the hand of the lecturer.
- The opportunity to prepare, perhaps only hours before use, a television tape of an experiment which students could never see otherwise. By replaying the tape, the class could not only see the experiment as it was performed, but they could make observations, collect data from their seats, and, as a group, discuss the results and arrive at conclusions. As with films, the techniques



such as magnification, slow-motion, time-lapse photography would be readily available and could be easily used by the instructor as he and perhaps a student assistant prepare the tape.

- A library of single concept film loops packaged in cartridges and ready for immediate viewing simply by inserting the cartridge into a suitable projector. This library of film loops might be located in the instructor's office or in the library. Students having difficulty with a concept can be handed the appropriate cartridge and asked to view the film as often as they wish. Such viewing can be done in a study carrel or in a small quiet area. Home assignments of material where motion, color, or time is important can be filmed and students can borrow the film cartridges as they borrow books on reserve.
- A library of film loops on laboratory techniques for use in inexpensive projectors located in the laboratory. Similar films showing the operation of instruments can be placed in projectors and located beside the respective instruments. The results would be a saving of faculty time on routine laboratory matters.
- A lecture table, digital voltmeter with a read-out like a small basketball score board. This would be equipped with probes which would enable the instructor to measure experimental parameters such as temperature, voltage, pH, conductivity, vapor pressure. Lecture experiments, as for example the effect of concentration on the voltage of a galvanic cell, could be performed by the instructor with students collecting and working up data at their seats.

Each of these capabilities already is in operation in colleges. Nearly all are being used in chemistry classrooms. Films, for the uses indicated, now are available and more are being developed. The hardware, in most cases, is readily available at moderate costs and is remarkably easy to use and to maintain. While instructors will find it takes time to produce quality materials with this new equipment, those who have tried agree that the work is far

more rewarding, much more foolproof, and much less time consuming than were efforts with equipment commonly available in the past.

It is for those who would use these new techniques and who would explore some of the almost unlimited number of teaching innovations they make possible that this report has been prepared. Its content is limited to three areas in which recent technological developments have created unusual new potential for college chemistry instruction. These areas are:

Portable TV tape recording systems.

Films and film loops.

Computer-assisted instruction.

The first section of each part of the report is a summary of present and potential instructional applications in the light of the new technological capabilities. The second section gives information regarding equipment, how to use it, where to buy it and, when possible, how to maintain it. In the second section, no effort has been made to list all manufacturers and all items of equipment. Materials listed are, in general, those with which some member of the writing team has had experience. The primary aim in this section is to inform chemistry teachers of the new equipment available and to provide them with sufficient background information to make an intelligent judgment about the purchase and use of such equipment.

TV systems. The first section of Part I on TV tape recording systems is largely a summary of the experiences of those who have used TV in chemistry instruction. It includes the findings of the Teaching Aids Committee television tape project conducted during the spring and summer of 1966. In this project, portable TV tape systems were sent to the chemistry departments at five colleges and universities (Michigan State University, Montana State University, Ohio State University, Stanford University and Washash College) where staff members made tapes of various chemically interesting phenomena and equipment. An evaluation of the tapes produced was made by several members of the Teaching Aids Committee in August of 1966.

The hardware section of Part I was prepared by a writing team of chemists with assistance and advice from television engineers and pro-

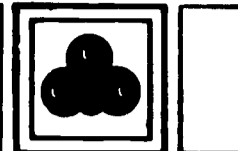

ducers from the industry and from the universities as acknowledged in the Preface. The writing team has made every effort to give an accurate but elementary presentation of the principles of TV tape recording. Unfortunately, the field of portable TV tape recording is so new that consensus among the experts often is difficult to obtain. Therefore, it became necessary to choose among alternatives on certain points in this section. Hopefully, these choices will not prove an inconvenience.

Also included in this section is a listing of the items needed in a basic TV recording installation and suggestions for expanding the TV capability.

Films. The first section on films summarizes some new uses of films and film loops and includes the results of several film preparation programs sponsored or stimulated by the Teaching Aids Committee. During the spring and summer of 1966, approximately 15 film loops illustrating various applications at all undergraduate levels were prepared. Some of these are original films, others were made by extracting footage from existing films. The film preparation programs are continuing to produce sample loops which will be available on request.

Also included in this section are lists of film sources and sources of film reviews.

In the hardware section, an effort has been made to bring together the principles of movie projection. Included are subsections on film formats, on projectors and their characteristics, on lenses, sound, screens, and on some new developments in still-projection techniques. This section should serve as a handy guide when purchasing equipment and when setting it up so as to obtain the best results.

Computer-assisted instruction. Chemists are just starting to experiment with this new tool. Hence, the experience here is sparse, and the treatment is elementary. Diagrams are given illustrating the principal of shared time computer use in instruction. A sample of student-computer dialogue is included to indicate the kind of interaction that is possible here. While this sample includes especially elementary chemistry to make the point in limited space, actual computer lessons could be on topics con-

siderably more complex. Such lessons would force the student to think his way through the problem presented, often allowing him alternative routes to solutions or permitting him to move some distance along a non-productive path before bringing him back to a potentially productive one.

While computers undoubtedly will be used in instruction in numerous other ways, our experience at present is insufficient to report intelligently on these. Nevertheless, projects to explore the uses of computers as in class aids (c. f. Bell Telephone example given earlier) and to prepare some computer-animated films are underway and, hopefully, will be the subject of a subsequent report.

Teachers may well ask if they must become audio-visual aids experts and thereby dilute their subject matter competence. Those who have tried these new techniques believe that they not only enhance the efficiency of presentation but they also enrich the learning process, thereby increasing the quality of instruction.

The top priority problem in chemical education today is to discover how to develop chemists who have in their minds a much larger body of chemical knowledge and greater facility in its use than chemists have had in the past. Without this the research of the future will be severely limited. For this reason, all avenues which will speed up the learning process should be explored thoroughly. Hopefully, the efforts stimulated by new developments in audio-visual hardware will be a start in this exploration.

Members of the writing team had an opportunity to visit an elementary school where computers were used in an experimental project to teach reading to first grade students and arithmetic to fourth grade students. The staff had not evaluated the effectiveness of the project but they stated that although the youngsters seemed to enjoy working briefly with the computer they would do anything possible to get personal attention. If this understandably human trait carries over into the college age group, it suggests that the best learning experience will continue to be centered around a live teacher, but assisted by the best that technology and a film maker's art can provide.

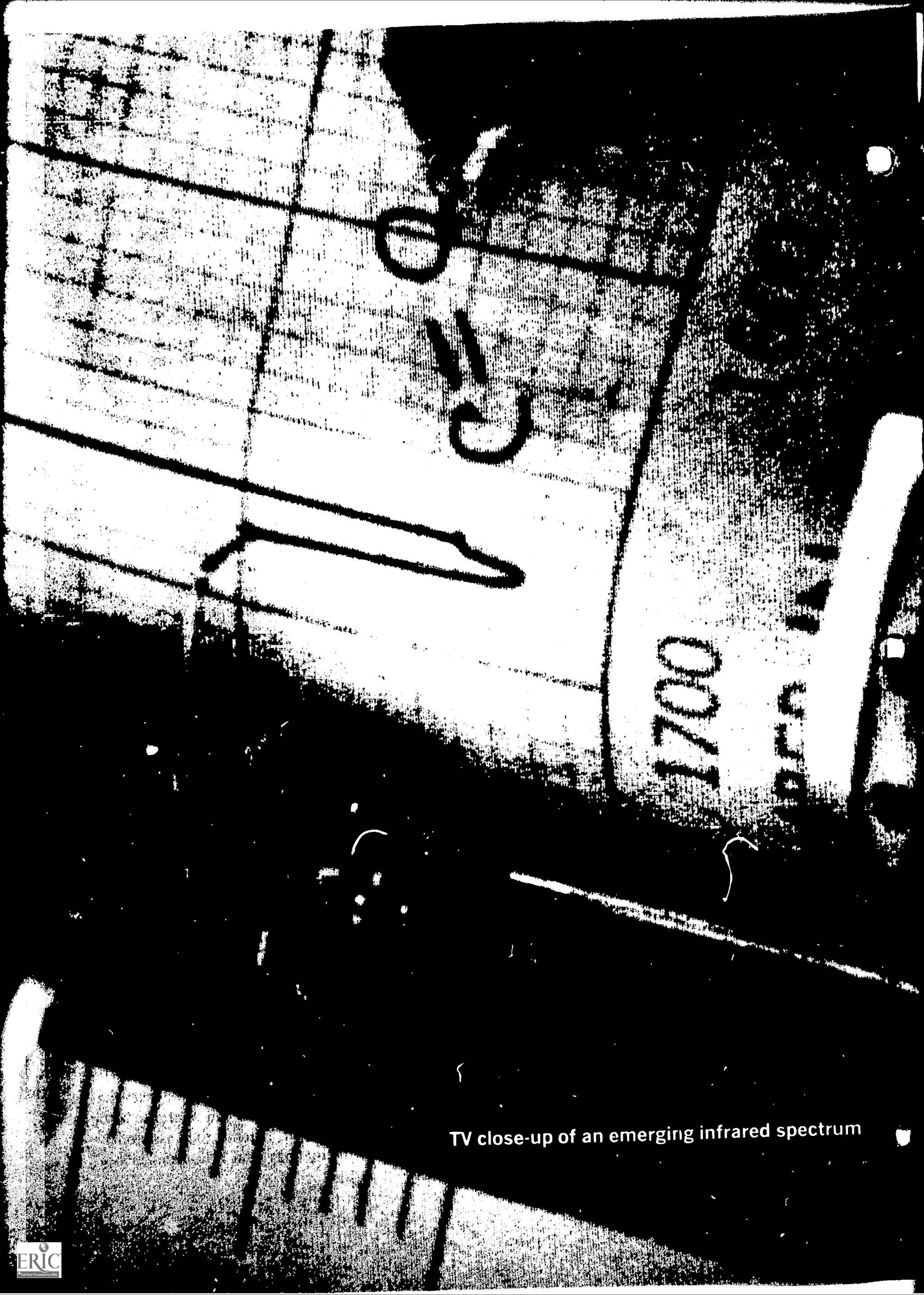

TV close-up of an emerging infrared spectrum

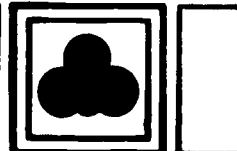

PORTABLE VIDEO TAPE RECORDING SYSTEMS

TV IN CHEMISTRY INSTRUCTION

Television has been used in college chemistry courses in numerous ways, most often in general chemistry.* For example, chemistry departments in several schools including the University of Minnesota and Purdue University have used it for pre-laboratory discussions and to illustrate specific laboratory techniques. At the University of Texas and at Oregon State University the lecture and laboratory portions of general chemistry courses have been put on kinescope film. The kinescopes have been used repeatedly at the originating institution and they have been telecast to neighboring colleges. At the University of Florida general chemistry lectures were taped and shown to many small groups of students thus eliminating some of the large sections. At Montana State University and at Rensselaer Polytechnic Institute live and taped TV have been used as a lecture demonstration aid.

Various techniques were used by the instructors responsible for developing these television presentations. For example, at Oregon State kinescopes of the lectures and laboratory experiments were prepared and these were projected on large screens. At most schools the taped or live presentations were shown to students on TV monitors located in classrooms or in laboratories. Classrooms of all sizes suitable for groups of from 20 to 500 students have been equipped with monitors and used successfully for TV presentations.

A television camera located on the lecture table and used to magnify demonstrations, to transmit and enlarge a photograph or diagram, or to convey the instructor's written words have been used at Rensselaer and at Montana State.

In general, attempts to replace the live lecturer by an instructor appearing on a television monitor have not persisted; however several of the other applications, such as the teaching of laboratory techniques, magnification of lecture experiments and demonstrations using both live

television and tape in the classroom continue to be used.

New Capabilities and New Uses Perhaps the greatest potential for television in increasing the quality of chemistry instruction lies in the utilization of the recently developed, relatively inexpensive and rugged portable television tape recorders. These recorders make it possible for even small chemistry departments to own a closed-circuit television system — a camera, a TV tape recorder and monitors or a projector. With this equipment instructors can utilize live TV in their classrooms or they can make their own tapes with a minimum of effort.

Video tape can record anything that can be seen. It can do so simply and economically on magnetic tape that can be erased for re-use when the recorded information is no longer useful. Portable recorders, only twice the size of a standard office typewriter, are priced from one to four thousand dollars and can be used easily and dependably in the laboratory or classroom by instructors or student-assistants. Immediate playback on any number of television screens is as simple as the playback of audio tape.

Video tape can bring into the classroom, instruments and apparatus that students would never see otherwise. For example, the operation of the mass spectrometer, and the details of the electron microscope or the sample chamber of a spectrophotometer now can become available to all students. Tapes can be prepared so that students can take readings from the dials or from the charts of the instruments being used in the experiment. In addition, unique or hard to arrange events can be recorded for repeated viewing. Video tape recording also stores and repeats material of temporary interest whether it be instructions to the multiple sections of a teaching laboratory or a record of a new teaching assistant's conduct of a class which he can later view and criticize.

The video tape recorder serves well as an

*We are grateful to the following for supplying summaries of their experiences with television teaching for this report: Professor J. F. Baxter, University of Florida; Professor R. C. Brasted, University of Minnesota; Professor R. L. Livingston, Purdue University; Professor L. O. Morgan, University of Texas; Professor R. O'Connor, Kent State University (experience at Montana State); Professor H. Richtol, Rensselaer Polytechnic Institute; Professor W. H. Slabaugh, Oregon State University.



erasable slate on which to try, test and immediately criticize visual aids to understanding chemical principles and practices. It is a medium for impromptu creativity. On the spur of the moment, an instructor can record an illustration for his lecture. After using it, he can decide whether the recording should be saved, altered or erased and forgotten. In general, video tape recording should be used when it can provide learning situations not available otherwise.

During the summer of 1966, television tape recorders and cameras were sent to chemists at several colleges and universities. These teachers were asked to test the equipment and to pre-

pare tapes of experiments, demonstrations, models, or other instructional features which they felt could be shown more effectively by this medium than by conventional methods of presentation. Without exception, all of these teachers were impressed with the potential of this medium and with the ruggedness and ease of operation of the equipment. Table TV-1 is a summary of the kinds of tapes prepared in this project.

In addition to these tapes, a variety of other applications made possible by chemistry department-owned-and-operated video systems have been tried or suggested. Some of these are listed in Tables TV-2 and TV-3.

TABLE TV-1

Examples of Tapes Prepared by Chemists Using Portable Video Recorders	
Topic	Description of Tape Prepared
IR Spectrophotometer	Preparation of sample; loading and operating spectrophotometer; interior operation of instrument.
NMR Spectrometer	Preparation of sample; loading and operation of instrument.
X-ray Power Analysis	Preparation of sample; loading x-ray camera; measuring the line separations.
McLeod Gauge	Operation and reading of instrument.
Vapor-Liquid Chromatography	Preparation of sample; operation and reading of instrument.
Crystallization	Recorded directly; camera mounted on microscope.
Reading Burets	Meniscus spread across TV screen.
Reading Charts	Charts and oscilloscope screen spread across TV screen so reading can be made from monitor.
Operation of Vacuum Line	Operation of vacuum pump; reading of manometer.

TABLE TV-2

Examples of Uses of TV Tapes in Chemistry Laboratory Instruction		
Instrument Instruction	Specific Techniques	Laboratory Examinations
Balances	Crystallization	Complete experiments
pH Meters	Titration	Pre- and post-lab sessions
Spectrophotometers	Quantitative transfer	Summaries of data from group experiments
Calorimeters	Chromatography	

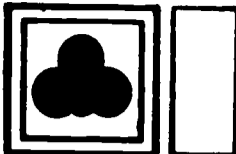
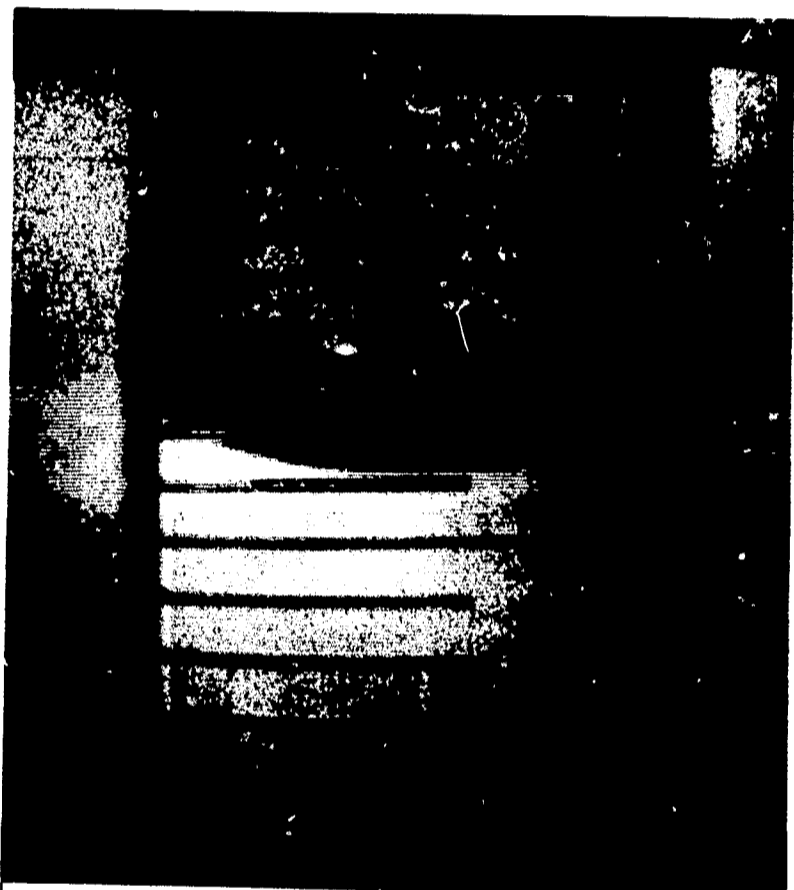

TABLE TV-3

Examples of Uses of TV Tapes in Lecture and Outside Class Instruction	
In-Class Uses	Outside-Class Uses
<ul style="list-style-type: none"> —Lecture experiments and demonstrations; difficult or dangerous experiments; large instruments; —historically important experiments. —Models difficult to enlarge otherwise. —Examinations or parts of examinations. 	<ul style="list-style-type: none"> —Preparation of tapes for class use. —Preparation of tapes for use as reference material by students. —Preparation of tapes for use as reference material by students. —Preparation of tapes for use as reference material by students. —Preparation of tapes for use as reference material by students. —Preparation of tapes for use as reference material by students. —Preparation of tapes for use as reference material by students. —Preparation of tapes for use as reference material by students.



Close-up of a buret as seen on a video monitor

Preparation of Video Tapes In many educational situations it is desirable to present pictorially a concept, technique or process in an informal manner. For instance, a brief illustration of an extraction with a separatory funnel compared to the operation of a counter-current distribution apparatus could easily be recorded in the afternoon or evening for a presentation the next day. Such taping could be done by the faculty member with the assistance of a teaching assistant. In general, while the faculty member needs to have access to the expertise of an audio-visual man or department, the production of a video tape should be and easily can be under the sole direction of the subject expert, the faculty member.

In preparing such a tape sequence, the instructor ordinarily would arrange the materials and then rehearse what he plans to do with the camera turned on and with the output made directly into the monitor. In this way, he or the assistant can see each operation as it will eventually appear on tape. Even after rehearsals and recording on the tape, if a particular sequence is unsatisfactory, it is very simple to erase the tape and re-record the section.

All of these capabilities need to be explored and exploited in college chemistry. To do so requires some familiarity with the underlying principles, nomenclature and equipment of television tape recording. Following is a brief discussion of the equipment needed for video recording including sources and costs. This will be followed by a brief discussion of some principles of video tape recording.

CLOSED CIRCUIT TELEVISION SYSTEMS

The essential components needed in a basic system for live video recording are indicated in Figure TV-1. Although the first portable video tape recorders required an engineer in attendance, now any of the professional or near professional staff associated with a chemistry department can learn to operate one in a few minutes. Probably the biggest change in the last year, however, is the advent of really good recorders priced under \$5000. Examples of these and slightly more expensive recorders are given in Table TV-4. With a camera and all necessary accessories, the total price for a modest but thoroughly useful beginning television recording installation is under \$7500.

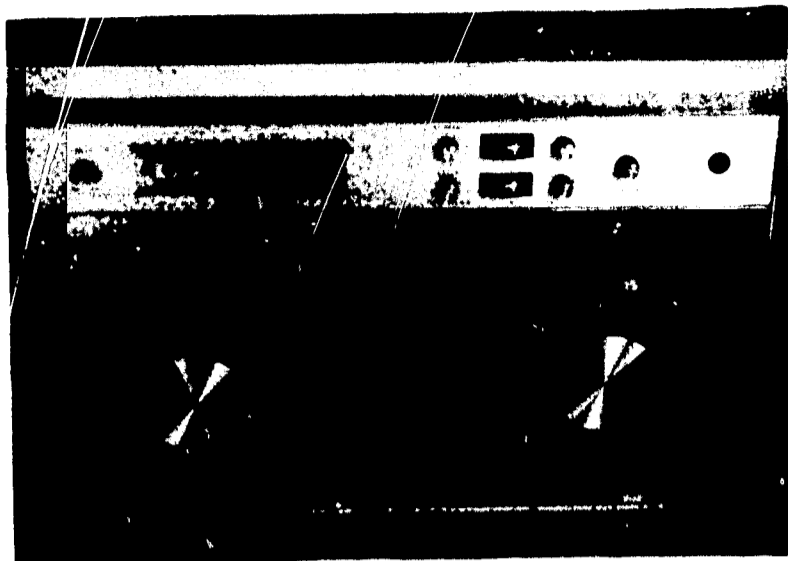

An AMPEX video tape recorder

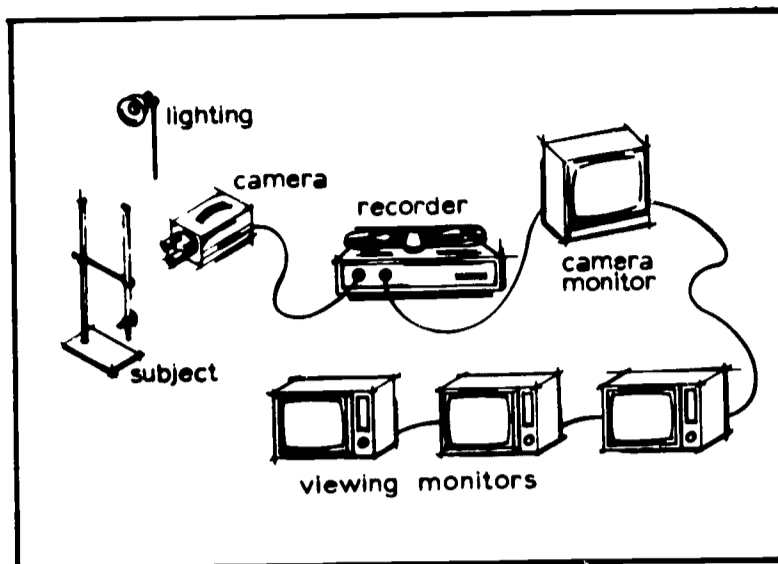
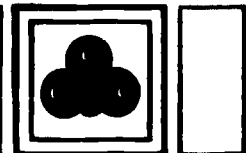

FIGURE TV-1
Elements of a video recording system

TABLE TV-4

Representative Portable Television Tape Recorders							
	Ampex 640	Sony PV-120-V	Ampex 7000	Sony EV-200	Concord VTR-600	Sony SV-300	Wollensak VTR-150
Tape Size	2"	2"	1"	1"	1/2"	1/2"	1/2"
Max. Playing Time/1 reel Tape.	4 hr.	90 min.	1 hr.	1 hr.	1 hr.	1 hr.	1 hr.
Sound Capability. (Channels.)	2 Chan.	2 Chan.	1 Chan.	2 Chan.	1 Chan.	1 Chan.	1 Chan.
Remote Controls Useful for complete remote operation.	No	Yes	No	No	No	No	No
Ease of Operation:							
Rapid Fd'wd.	Yes	Yes	No	Yes	No	Yes	Yes
Rapid Reverse.	Yes	Yes	Yes	Yes	Yes	Yes	Yes
Stop Motion.	Fair	Good	Fair	Good	Fair	Fair	No
Slow Motion.	No	Good	No	Good	No	No	No
Output	Video	Video	Video R.F.	Video	Video R.F.	Video R.F.	Video
Resolution* (center lines, horizontal)	250	320	350	320	250	180	Not Available
Tape Speed, Inches/sec.	3.7	4.5	9.6	7.8	12	7.5	7.5
Weight	100 lb.	150 lb.	100 lb.	88 lb.	52 lb.	45 lb.	50 lb.
Cost of 1 hr. tape	\$70.00	\$75.00	\$59.50	\$69.00	\$59.50	\$39.95	\$39.95
Recorder Price	\$8000.	\$8950.	\$3150.	\$4200.	\$1150.	\$1250.	\$1495.

*Picture quality is affected by signal-to-noise ratios and other factors in the chain of equipment from camera to monitor. Resolution of the recorder should not be taken as the sole factor for determining good definition in the reproduced television picture.



The basic video recording installation. The following basic components are needed in any initial installation:

One camera with internal 2:1 synchronizing generator such as General Electric TE-20A	\$1595.00
One zoom lens such as Angenieux 25-100 mm f 2.8 with close-up attachment and extension tubes	450.00
One tripod, head and dolly such as Quick-Set Samson tripod (7301), head (7201) and dolly (7601)	148.00
One camera monitor-receiver such as the 5-inch Sony PVJ-305 RU	260.00
One omni-directional dynamic microphone such as Sony F-91	90.00
One one-inch video tape recorder with slow and stop motion capability such as Sony EV-200	4200.00
One 23-inch viewing monitor such as Conrac model CVA23	400.00
Total	\$7143.00

Where the full horizontal resolution capabilities of the camera are to be reproduced and maximum reliability is required, a Conrac industrial type monitor should be used. If a mod-

erate compromise in quality is necessary for reasons of economy, the Setchell-Carlson model 2100 would be a good choice. Television projectors which project the video image on large screens are available and have been successfully demonstrated. Table TV-5 lists some TV monitors and projectors, their characteristics and costs.

As a practical consideration, it is important to use unmodified industry-standard components and connectors in assembling the basic installation to permit ready introduction of additional equipment.

Expansion of the basic video recording installation The first component likely to be added to the basic video system is a second camera to permit rapid switches from close-ups to wide-angle views. Table TV-6 gives some representative TV cameras, their characteristics and costs. In addition to the cost of the camera, some switching system and a slight alteration in the camera sync system is necessary. The switching system may be a simple switch costing less than \$75.00 (Packard-Bell VS-3) or a dissolving device which provides the capability of a continuous blend from one camera to another. The General Electric TC-59A switcher-fader costing \$700 will do an adequate job for simple systems.

TABLE TV-5

Representative Television Monitors and Projectors					
	MONITORS			PROJECTORS	
	Conrac EMA 23/c	Setchell Carlson Model 2100	G.E. CAM 603 BVY	Amphicon 200	100
Screen Size	23"	23"	23"	4' wide	20' wide
Resolution (horizontal center lines)	800	600	320	600	600
Input	Video	Video R.F.	R.F.	Video R.F.	Video R.F.
Sound Capability	Separate and Extra	Included	Included	Included	Included
Cost	\$400.00	\$260.00	\$150.00	\$2,800	\$15,000



TABLE TV-6

<p>Model 1000</p> <p>\$1,595.00</p>	<p>Model 1000</p> <p>\$1,595.00</p>	<p>Model 1000 w/pushbutton</p> <p>\$2,975.00</p>	<p>Model 1000</p> <p>\$2,000.00</p>
-------------------------------------	-------------------------------------	--	-------------------------------------

When two cameras are available, it is also possible to use a special effects generator such as Ball Brothers Mark VI-A (about \$1,375 plus \$50 camera modification). Video information such as captions or numerical data can be superimposed by means of the special effects generator over the primary video image ("matting"), or such information as close-ups of instrument parts and diagrams can be inserted onto a selected portion of the screen (split screen technique).

Additional lenses for the camera may eventually be desired. If funds are available, the basic camera might well be equipped initially with a 10:1 rather than a 4:1 zoom lens such as the Angenieux 15-150 mm f 2.8 for \$790. A turret carrying a zoom lens and a one-inch fixed focal length lens for high definition close-up work is a logical step beyond a single lens. Fixed focal

length lenses are generally sharper than zoom lenses. A turret with several fixed focal length lenses costs as much as a first class zoom lens although not affording the zoom capability. Angenieux zoom lenses are considered to be of excellent quality. Regardless of the lenses chosen, a set of standard C mount lens extension tubes (\$19.50) is handy for close-up work in the laboratory and any supplementary close-up attachments supplied by the manufacturer for a particular lens are generally worthwhile accessories.

While TV cameras will accept any standard 16 mm C Mount lens, many of these lenses are designed for photographic cameras and are not suitable for television cameras. Lenses with a maximum opening of f/1.9 or f/1.4 and having working distance no longer than 24" and as short as 18" probably will be most useful for the work described here.

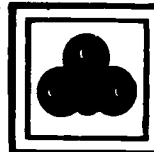

A basic camera can be equipped as follows:

Turret mount	
Three lens turret,	\$196.50
Lens, 1" f/1.5	85.00
Lens, 2" f/1.8	122.00
Lens, 6" f/2.8	119.00
Extension tubes for extreme close-up work	20.00
	<hr/>
	\$542.50

Turret mount	
Three lens turret,	\$196.50
Lens, 1" f/1.5	85.00
Lens, Zoom f/2.8 4-1 (17 mm-70 mm)	400.00
Extension tubes	20.00
	<hr/>
	\$701.50

Single lens mount	
Lens, Zoom f/2.8 10-1 (15 mm-150 mm)	\$790.00
Close-up rings	40.00
	<hr/>
	\$830.00

Camera supports. A number of excellent camera supports are available from "Quick-Set", Inc., Skokie, Illinois. In addition to the tripods and pan head recommended in the "starter set", an elevating camera support is available which can be built into the lecture demonstration bench. This type of support can be used in two ways: One, to insure that the instructor will have a convenient solid support on the lecture bench if he wants to use a live camera in class; and, two, on a cart designed to hold the TV tape recorder, camera and monitor. The cart and its contents is a complete closed circuit TV system and can be wheeled into laboratories to make recordings or into classrooms or teaching laboratories to display a taped or live video sequence.

Distribution of television signals Use of more than one viewing screen requires knowledge of the best method of connection. Whenever the recorder video output can be sent from one monitor to another in one continuous chain, it is only necessary to tie them together in series fashion with a cable for video and one for audio. Installations with as many as ten monitors are

common. A distribution amplifier is needed only when very long cables are required (as from one building to another) or when parallel rather than series connections are required in a branching distribution to different rooms or buildings.

If many outlets are needed over a large area, it is possible that conversion to an RF signal might be justified. In the latter case, several independent signals can be transmitted over the same coaxial cables, or transmission can be broadcast over the 2500 megacycle channel allocated to educational institutions. Nevertheless, it is significant that experienced television users consider high resolution to be the most important quality required for scientific purposes. The best RF system will not transmit pictures as sharp as a video-audio cable system.

Lighting Usable video pictures can be made with standard equipment in light levels too low for comfortable reading. Consequently, existing room light often is perfectly satisfactory. If additional lighting is required, simple lamps ordinarily are sufficient. Chemists should know that high intensity light — such as burning magnesium — can destroy a vidicon camera tube.

Maintenance Television recorder heads require regular maintenance not unlike that required for instruments used constantly by chemists. The SONY and AMPEX recorders used in these studies are remarkably rugged and require little service as new instruments. This equipment has been shipped around the country by plane, rail, bus and car. It rarely has failed to operate. However, the recorders are largely transistorized and complex. Moreover, their recording and video heads have lifetimes of 500 hours or more and must be changed periodically. For these reasons, recorders must be repaired by especially trained technicians. Manufacturers will train appropriate personnel to maintain and repair their equipment. Regional service facilities are available for SONY and AMPEX. Many dealers offer service contracts.

Video Tape The life of a video tape is limited. Depending on the manufacturer of the tape, and recorder, it has been estimated that from 100-1000 "passes" can be expected during normal tape usage. A pass is defined as any time the video tape goes past the recorder heads, e. g., to

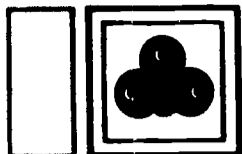

record and play back one scene would involve two passes of the tape. Fast forward and re-wind modes are not considered a pass, as the tape tension is released and the tape is thus not in pressure with the recorder heads. In common usage, the term play and pass are considered to be equivalent.

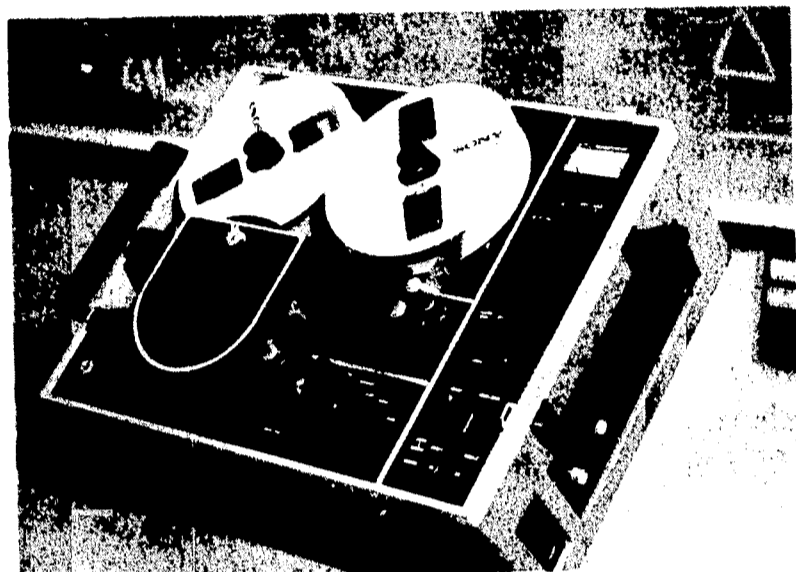

A SONY video tape recorder

Large Screen Television Projection The design of many chemistry classrooms is not convenient for the placement of TV viewing monitors. If the students are expected to take data from the television picture, optimum locations for each viewer should be considered.

In general, students should sit no further than 20 feet from a 23" TV monitor. Excellent recommendations for monitor placement are available in *Design for Educational TV* by Educational Facilities Laboratory, New York, N. Y., 1960.

By contrast, one large-screen TV projector can accommodate the entire class with a simplified installation. Projectors are available which project a TV image up to 20 feet wide (see discussion of optimum image size in film section). Most currently available TV projectors are limited in that their light output is so low that a semi-dark or a completely dark classroom is necessary. Also the lenses available on many models require the projector to be placed in a close relationship to the screen. This could be troublesome in the traditionally designed chemistry auditorium. The cost for the larger TV projectors is quite high. An installation of a large screen TV projector is now being made in a 350 seat capacity chemistry auditorium at Ohio State University. Plans are to use the projector,

video tape recorders, and a lecture bench camera in the general chemistry lectures.

Color Television Although color television would be desirable, and in some cases necessary to the chemist considering the use of this medium, it will be some time before color TV will be suitable for chemistry's exacting requirements. At present, color television cameras sell for \$60,000 to \$70,000, and color video monitors are priced from \$2,500 up. In addition, the picture resolution is lower than that of a comparable monochrome picture. Color standards also are hard to maintain over existing distribution systems. Chlorine gas, for example, can easily be green, blue, or shades between, depending upon how the receiver is adjusted.

Industrial sources indicate that it may be at least three years before a significant change is made in color television cameras and monitors. Even with major changes promised, the price of color equipment possible will be no less than one-half the cost of color today.

Color television using an unconventional principle has been demonstrated by Japanese manufacturers. However, it is not compatible with American standards. Although considerably lower in price, its potential and availability in this country will not be known until late 1967.

Manufacturers of most portable recorders are prepared to add color capability by next year. The cost for adding this feature according to one manufacturer will be close to the present selling price of the one inch recorder.

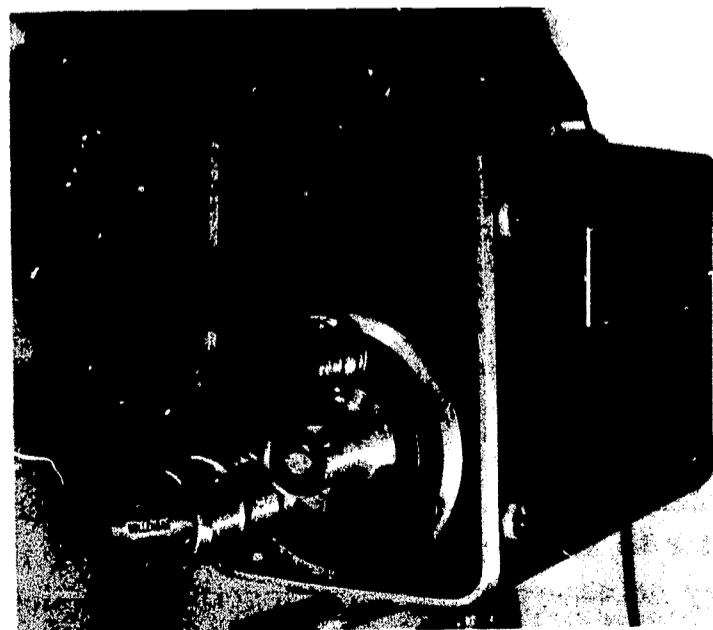

Front view of a TV camera showing several lenses mounted on a turret.

PRINCIPLES OF VIDEO TAPE RECORDING

Role of television cameras and accessories The first step in a television system is to generate an electrical equivalent of the scene. By means of a lens the subject is brought into focus on a photoconductive surface in the pickup tube of the camera and the resulting image is scanned by an electron beam. The amount of light the beam encounters at any instant determines the magnitude of the camera tube current and hence the video signal from the camera. Since the video signal ultimately modulates the intensity of an electron beam which scans across the face of the television viewing screen, it is necessary that the camera tube and viewing screen scanning be synchronized. A synchronizing generator built into the camera or elsewhere in the system generates electrical pulses which lock together the scanning beams in the camera and monitor.

The light sensitive tube used in cameras under consideration here is called a vidicon tube. It is highly sensitive, sturdy, and costs about \$170.00. Image-orthicon tubes used in commercial television are expensive, bulky and delicate. They need not be considered for the applications discussed here.

The electron beam of a vidicon tube sweeps across the light sensitive surface from left to right so as to divide the image into 525 horizontal segments called lines. Each line segment of the video signal is ultimately reassembled in the monitor where the scanning beam starts at the top left of the image and sweeps to the right and down at a uniform rate (figure TV-2). At the end of each sweep line, the beam returns rapidly to the beginning of the next line in its field. During this retrace period, no video signal exists.

An interlaced scanning system is used to reduce flicker. The scanning beam skips every other line down the screen, then returns to the top to scan the alternate lines interlaced between the first set. Each set of horizontal lines is called a *field*, and the two combined sets are called a *frame*. Since each field contains $262\frac{1}{2}$ lines, the beginning of the second field is dis-

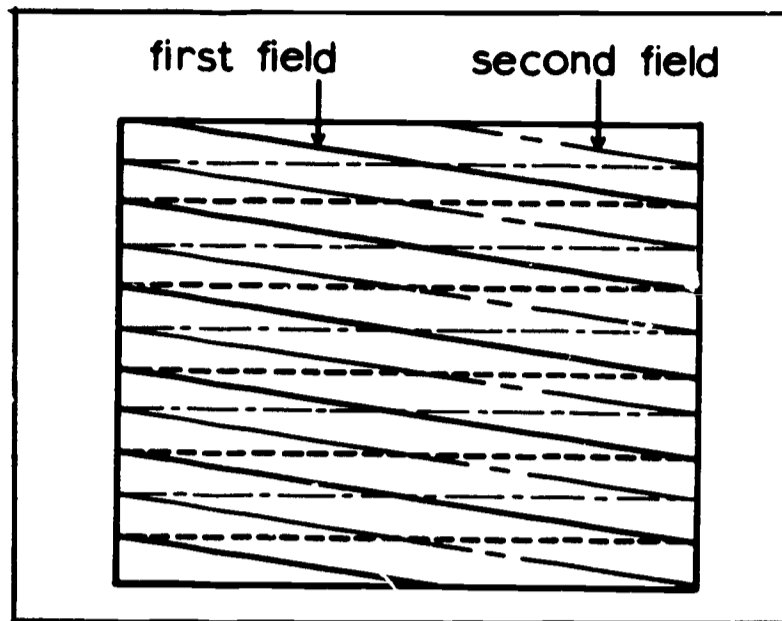

FIGURE TV-2
Interlaced scanning principal

placed horizontally half a line. The complete frame therefore contains 525 scanning lines. Scanning speed is such as to generate the television picture at the rate of thirty frames a second.

Video tape recording Video tape recording is presently accomplished by methods quite similar to magnetic sound recording. The essential parts of a video recorder (Figure TV-3) are a magnetic tape, some kind of tape transport mechanism, and the recording (or playback)

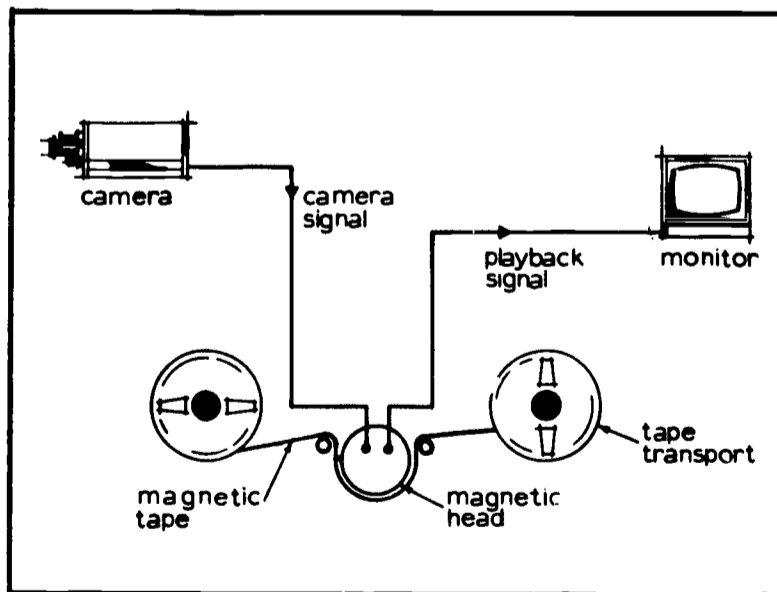
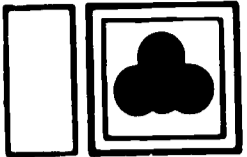

FIGURE TV-3
Elements of a video tape recorder

head. The recording head converts the modulated electrical signal from the camera into a variable magnetic field which impresses a pattern of magnetization into the magnetically susceptible coating on the recording tape.



Playback of the recorded signal is accomplished by passing the magnetized tape across the head. As the head moves past the tape, the varying magnetic field generates a modulated output voltage which controls the electron beam scanning the monitor screen.

Video recorder heads A video recording head, like that of an audio recorder, consists of a magnetic element interrupted by a nonmagnetic gap across which the tape passes. The width of this head gap is important because it is related directly to the upper limit of recordable signal frequency:

$$\frac{\text{tape speed}}{\text{head gap}} = \text{maximum recordable signal frequency}$$

Heads can be manufactured to record high fidelity sound (20,000 cycles per second) at tape speeds of $7\frac{1}{2}$ inches per second or less using head gaps of the order of five microns, but good video recording requires response in excess of four megacycles. Fixed head video recorders operate very much as do their audio counterparts and in principle represent the simplest and therefore the most inexpensive recorder mechanism. Nevertheless, they require either exceedingly high tape transport speeds or an extraordinarily narrow head gap. Although prototype fixed head machines have been demonstrated, no manufacturer presently markets one. Attention is now focused on the development of ingenious rotating heads which provide high effective tape speeds at an economical rate of tape transport.

Rotating video recorder heads Portable recorders utilize tape wound around a rotating head in a helix (Figure TV-4); or a segment of a helix (Figure TV-5)

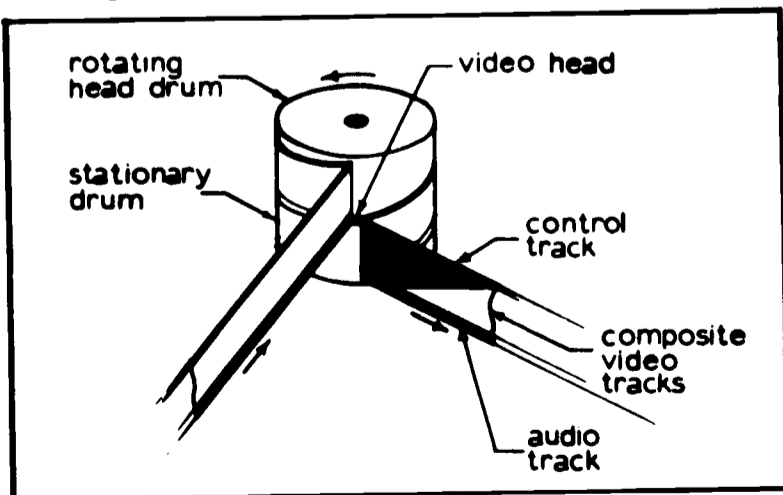

FIGURE TV-4
Full helical-wrap rotating head for video recorder

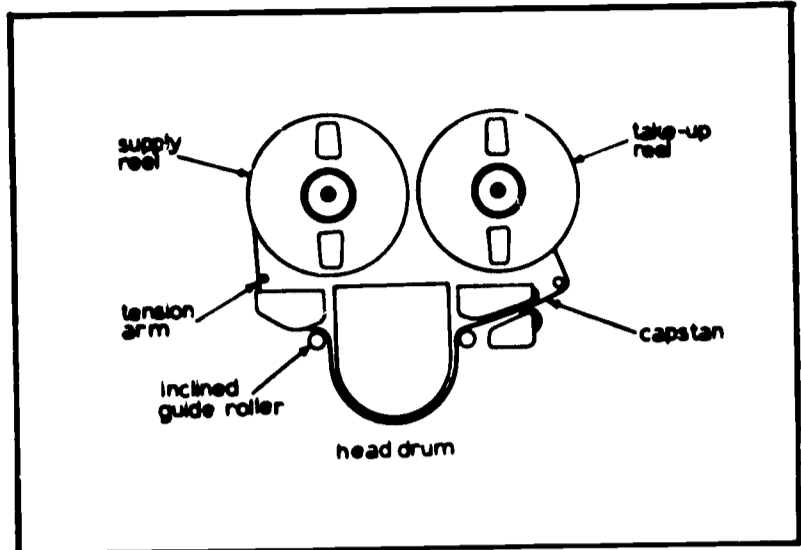

FIGURE TV-5
Diagram of a video tape recorder with a partial helical-wrap rotating head

The tape travels past the recording head at a relative slow speed while the recording head revolves rapidly (1800 - 3600 r.p.m.) in the opposite direction. This system ("slant track recording") places the video signal on the tape as a series of diagonal lines (Figure TV-6) at a "writing" speed of perhaps 680 inches or more of tape surface per second.

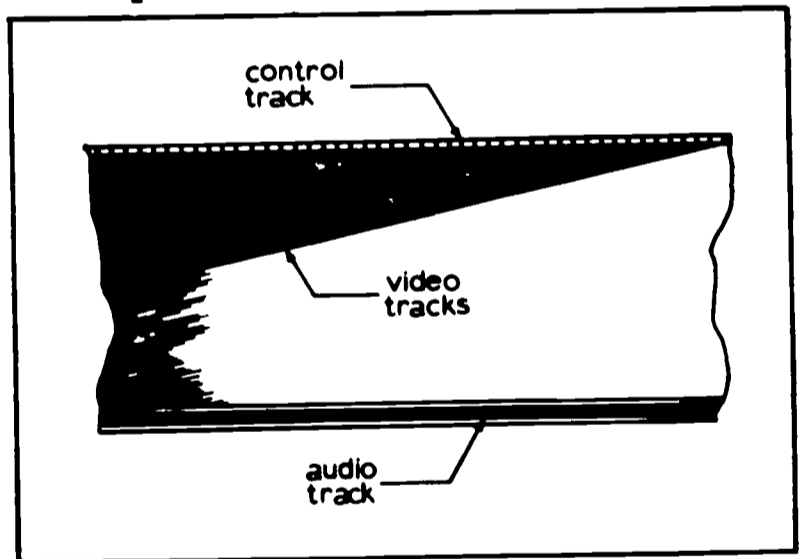





FIGURE TV-6
Illustrating a slant track video tape recording

Although helical scan recorders generally do not meet the standards of studio machines in broadcast television, they are entirely adequate for all but the most critical high resolution educational applications and at the same time offer simplicity, dependability, and portability at a low price. Helical scan recorders using magnetic tape either one or two inches wide can give pictures sufficiently sharp for scientific uses.

Image sharpness in video recordings The most significant figure used to describe the merit of a television system is its horizontal resolution —



i.e. the number of vertical lines than can be differentiated in the width of the picture. (Lines resolved by a system should not be confused with the number of lines scanned by the camera or monitor.) The best commercial broadcast television systems resolve 350 lines, but 300 line resolution on a home receiver is considered excellent. One-inch tape recorders of the type considered should resolve over 300 lines and a half-inch tape recorder should approach 200 line resolution.

Image sharpness on the monitor screen is a subjective quality that depends not alone on line resolution. Lighting and subject contrast also affect sharpness. Inexperienced video photographers can profitably study techniques used by film photographers. Since the image on a viewing screen is influenced by the quality of each component in the total system, equipment of comparable quality throughout is recommended. It would seem unwise for example to use a camera capable of resolving 800 lines with a tape recorder capable of only 200 lines of resolution.

Editing, Interchangeability and Standards Unneeded footage can be edited from video tape by two methods. The first involves recording the information from one tape to another, omitting the unneeded portions in the transfer. The edited copy will contain very short periods of "snow" (noise) indicating the stopping of the recorder at the editing points. The second method of editing involves physically cutting and splicing the tape. Inexpensive tape splicing blocks can be made in the machine shop. Splicing instructions are supplied with the recorders. "Electronics Editors" are supplied with expensive recorders.

While tapes usually can be transferred from one tape recorder to another of the same manufacturer without significant loss of picture quality, it is not possible to interchange tapes between recorders made by different manufacturers. This is because the design of the video recorder heads varies considerably among manufacturers.

Since few standards are available to assure consistent reproducibility of tapes made on helical-scan recorders, the AC₃ has prepared standard tapes for the AMPEX and SONY re-

recorders. These tapes contain stair-step, Multi-burst and Windowed-sine squared test patterns and are designed to standardize resolution measurements and to aid in instrument adjustment. Copies of these tapes are available. Their use should help make possible the exchange of tapes from one school to another with a minimum loss in picture quality.

SELECTED REFERENCES

1. **Closed Circuit Television-Definitions:** Electronics Industries Association, 11 West 42nd Street, New York 36, New York (\$1.00)
One hundred and thirty definitions, formulated by EIA Engineering Committee on Closed Circuit Television are listed. Ranging from "Aspect Ratio" to "white compression," the definitions cover terms one will encounter in using video equipment.
2. **Fundamentals of Television and Essential Optics** (EBI-3711), General Electric, Electronics Park, Syracuse, New York, 1964. (8 pages, free)
3. **Fundamentals of The Vidicon Tube and Transistor Characteristics** (EBI-3781A) General Electric, Electronics Park, Syracuse, New York, 1964 (7 pages, free)
4. Enger, Richard A. (ed.) **Teaching with Videotape.** St. Paul, Minnesota: Dept. of Communication, 3M Company, 1961 (free)
The value of this publication is limited by the developments in video tape recorders since 1961.
5. Lewis, Philip. **Educational Television Guide Book.** New York: McGraw-Hill, 1961. (\$5.50)
A textbook for the serious student of educational television. Closed circuit television is treated in detail.
6. Schaefer, Chris H. and Suzman, Cedric L. **Video Tape Recording,** Hobbs, Dorman & Co. Inc. New York, 1965 (\$12.00)
A comprehensive and carefully documented report on "Video tape recording" — with latest information on video tape technology and recording equipment. An instructive book for the communications industry, the business man, and the general public. A comprehensive bibliography is included.
7. Wade, Warren L. **Television Tape Recording Systems: A Guide for School Administrators,** January, 1964. Reprinted by Ampex Corporation, Redwood City, California (free)
An examination of portable television tape recorders as they relate to school district needs.

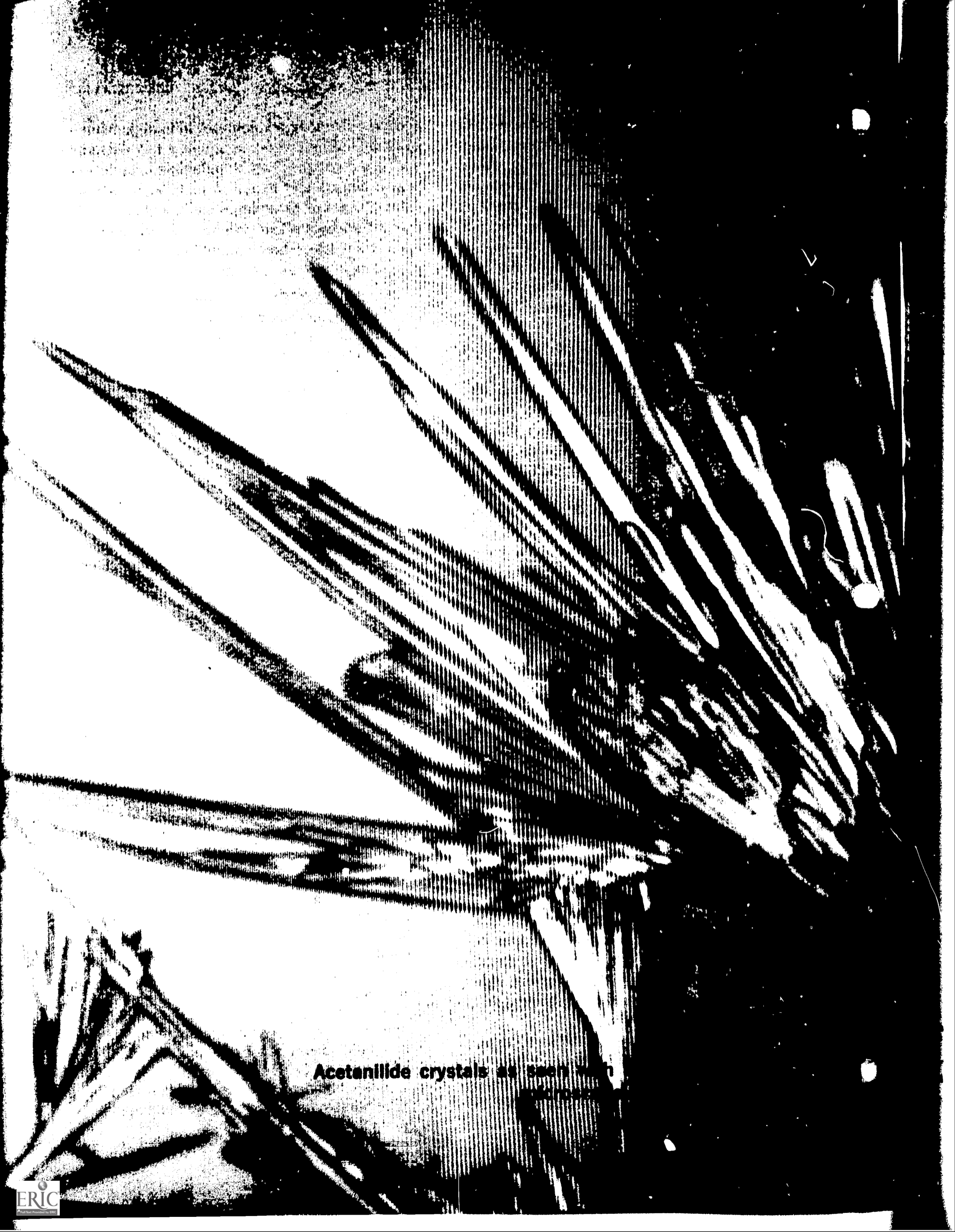

Acetanilide crystals as seen with

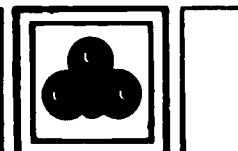

FILMS AND FILM LOOPS

NEW USES FOR FILMS

The mechanical and logistical problems associated with integration of films as part of a lecture often have been a deterrent to their use. Obtaining a projector (and often a projectionist), threading it, insuring that it is operating properly, and that the film will be successfully run without a breakdown, are conditions not easily met. Too often the classroom showing becomes a parody on the debacle commonly called home movies. Nor does the solution of the mechanical problems end the difficulties. The majority of films which have been available on chemical subjects were not designed for classroom use, and certainly not for classroom use in the light of the subject matter as it is being presented today.

Considerable evidence is accumulating which suggests that if the mechanical problems can be solved, and if the instructor can be continuously informed of the sources and availability of good films, he will indeed use them in his classroom, or in other segments of his course.

In recent years, the film industry with the help of educational research groups has made unprecedented progress in minimizing mechanical and logistical problems. Projectors are already on the commercial market which accept cartridges containing film ready to project. Cartridge-loading projectors for short films (of the order of four minutes) or for films (of the order of half an hour) are available. The projectors are quite small, reasonably priced, and can be left in the classroom, laboratory, or study carrel most of the time. The cartridge merely is inserted into the machine, the film is shown and then is immediately ready for projection again. Even projectors for very large classrooms now come equipped with automatic film threading and rewind attachments. By means of remote controls located at the lecture table, these projectors can be turned on or off, restarted, reversed, or so controlled that a single frame of film can be held on the screen.

Most films nowadays come with sound. Some have provisions for addition of a second sound track by the user. Instructors should be encour-

aged either to supply their own sound track or to turn off the sound on a motion picture and talk. While it may be difficult when using a long film to synchronize one's own comments with what is going on in the film, the instantaneous stopping mechanism on the newer projectors enables the teacher to hold on one frame, to discuss a point appropriately, and to resume the motion when ready. The versatility of modern projectors is encouraging the production of single-concept films in which synchronization between the sound and the picture is much less critical than in traditional teaching movies.

A growing number of films particularly designed for college classroom work and for the level of work which currently is being explored at the college and university level, is becoming available. Whereas in the past there were essentially no films potentially acceptable beyond the freshman level, it appears very likely that there soon will be films which can be used at any level, including graduate courses. As chemistry becomes more abstract, as instruments become more complex and more important, as it becomes essential to expose the student to a wider and wider range of ideas and equipment which cannot easily be brought into the classroom, films will become more and more important. Already films are being prepared in which the student can see experimental data being obtained and can collect from the screen information which he can then work up and from which conclusions can be drawn.

As indicated earlier, motion pictures also are being used: a) to present specific chemical problems to which student viewers may proceed to seek solutions; b) in the laboratory to illustrate specific techniques or to provide visual instructions for operating or for understanding the principles associated with the operation of an instrument; c) in study carrels equipped with cartridge-loading projectors by means of which a student may privately view a film as many times as he wishes.

This section has been prepared to assist teachers who wish to learn more about these new



The reaction of potassium with chlorine photographed from
CHEM Study color film "Chemical Families."

directions in the utilization of films in college chemistry instruction. It includes:

Some specific examples of new uses of films and film techniques as they apply to college chemistry.

A list of sources of films, film loops and reviews of films.

A summary of the equipment currently available including sources, approximate prices and the background information needed to help make an intelligent selection and wise use of hardware.

Some specific examples. Films might be classified conveniently in terms of their intended use in teaching (pedagogical techniques), or in terms of the special visual effects they illustrate (film techniques). The latter are familiar from commercial movies; examples include close-ups,

stop-action, time-lapse. Examples of the former follow.

Single concept films. These are short, usually four to ten minutes, films on a single topic such as vapor pressure, enthalpy, hexagonal and cubic closest packing, pH, the discovery of oxygen-18, etc. Single concept films may be used as part of a classroom presentation or they may be assigned for independent study. Students may borrow, from the instructor or from the library, cartridges containing assigned films and view the films from projectors located in study carrels. Alternatively, the projectors with cartridges inserted and ready for use might be located in halls of the buildings, in laboratories, or in small classrooms. Some single concept films now available or in preparation are listed in Table F-1.

TABLE F-1

Some Single Concept Films Available or In Preparation		
Title	Producer and Characteristics	Availability
Infrared Spectra and Molecular Structure	Slabaugh-Ouellette; 4 minutes Technicolor cartridge	AC ₃ , February 1967
Interpretation of Vibration Spectra	Slabaugh-Barrow; 2 four minute loops, Technicolor cartridge	AC ₃ , February 1967
An Electrochemical Cell (Animated Mechanism)	Campbell-CHEMS; 4 minutes, Technicolor cartridge	AC ₃ , February 1967
A Silver-Hydrogen Electrochemical Cell	Campbell-CHEMS; 4 minutes, Technicolor cartridge	AC ₃ , February 1967
Molecular Vibrations using Models	Campbell-CHEMS; 4 minutes, Technicolor cartridge	AC ₃ , February 1967
Atomic and Bonding Orbitals	Slabaugh-Parsons; 4 minutes, Technicolor cartridge	AC ₃ , February 1967
Crystal Structure of Metals	Slabaugh; 4 minutes, Technicolor cartridge	AC ₃ , February 1967

Filmed lecture experiments. Chemists emphasizing experimental methods in their classroom teaching may have found that the classroom is too large for all students to adequately view what is taking place in the experiment on the lecture table. They also may have found that the equipment necessary to carry out the experiment appropriate to the class discussion was inaccessible to the lecture room for reasons of

cost, safety, size, geographical location, sensitivity of the instrument, conflict in use, or time required for preparation of the experiment. Possibly the time factor in the performance of the experiment is either greater than the time which could be devoted to the experiment in the classroom or too short for effective observation by the students. Under these circumstances filmed experiments might be most appropriate.



Lecture experiments on film might be prepared locally or purchased. They might be utilized:

1. To serve as the focal point for a dialogue between the teacher and the students, or among the students, preferably in the classroom, concerning the meaning or interpretation of the experiment. Such dialogues generally involve the analysis of the data or observations. They also may involve dis-

cussion of experimental techniques utilized in the experiment and of the possible source of experimental error and the influences of such errors on the experimental results.

2. To serve as the method of enabling the student to make the observations and to take data from the instruments used so that he may then analyze and interpret the experiment himself even though he did not actually perform it.

TABLE F-2

Some Lecture Experiment Films Available or In Preparation		
Title	Producer and Characteristics	Availability
Potentiometric Titrations	Slabaugh; 4 minutes, Technicolor cartridge	AC ₃ , February 1967
Ionization Energies	_____	Fall 1967
Distribution of Molecular Speeds	_____	Fall 1967
Electronic Spectra of ¹⁶ O and ¹⁸ O	_____	Fall 1967
Mass Spectrometric Determination of Mass and Relative Abundances of Isotopes of an Element	_____	Fall 1967

Utilization in the laboratory. Whereas films may be utilized in the classroom to give every student a "front row" seat, filmed and taped material may be used in the laboratory: a) to give every student individualized instruction when and where it will be most appropriate to his laboratory experience; b) to better organize laboratory instruction; and c) as the media for improved laboratory examinations. Mechanical problems associated with such uses of films in the laboratory have been surmounted by using cartridge-loading 8 mm projectors, both with and without synchronized sound. Using a rear-screen attachment on the projector, the film may be viewed in natural light as is a television screen. These projectors may also be purchased with earphones so that several units may be employed in a small room without audio interference.

Short films in which various laboratory operations are shown in a step-by-step fashion are becoming available. Examples are given in Table

F-3. Instructors may now refer students to filmed examples of techniques, equipment utilization, or instrument operation as necessary and appropriate to the student's work. Only those students who are in need of this particular instruction or information need be required to spend their time viewing the film.

In general, filmed and taped materials may be effectively employed to complement laboratory teaching in four ways:

1. To illustrate and standardize laboratory operations — that is to assist in the "telling and showing" function of the laboratory. An important example here is that color standards such as endpoints for indicators can be faithfully reproduced on film with some effort. In addition magnification and frame-slowness techniques make portions of the equipment and intimate details of processes vividly accessible. Safe practices and safety precautions also can be forcefully impressed on students with striking pictures.



2. To extend the scope of the laboratory work by presenting, to the student, additional experiments in which data and observations are generated and for which the student makes the analysis and interpretation by himself.
3. To move from verbalized quizzes and examinations toward laboratory practical examinations without becoming involved with massive logistical problems of administration of the examination.

4. To individualize instruction that is to present the individual student with the information he needs in the laboratory at the time it will be most beneficial to his learning.

In courses where students are rotated among experiments, films on laboratory techniques and operations can remove a large burden from the instructor thereby enabling him to work closer with the students in examining the significance of the laboratory work.

TABLE F-3

Some Laboratory Instruction Films Available or In Preparation		
Title	Producer and Characteristics	Availability
Titration	Slabaugh; 4 minutes Technicolor cartridge	AC, February 1967
Basic Laboratory Techniques	Barnard; 5 minutes Fairchild cartridge	AC, June 1967
Thin Layer Chromatography	Barnard; 6 minutes Fairchild cartridge	AC, June 1967
Techniques of Volumetric Analysis	University of Wisconsin; sound, 30 minutes, 16 mm reel	U. of Wisconsin Television Center
Using A Filter	Yale University; 2 minutes	Association Films
Quantitative Transfer	Yale University; 17 minutes, sound	Association Films

TABLE F-4

Some Instrument Instruction Films		
Title	Producer and Characteristics	Availability
Operation of the Mettler Balance	Slabaugh; 4 minutes, Technicolor cartridge	AC, February 1967
Single Pan Sartorius Balance	Slabaugh; 4 minutes Technicolor cartridge	AC, February 1967
Operation of the Beckman IR-8 Spectrophotometer	Ouellette; 4 minutes Technicolor cartridge	AC, April 1967
Operation of the B. and L. Spectronic 20	_____	AC, Fall 1967
Operation of the Vapor Chromatograph	_____	AC, Fall 1967

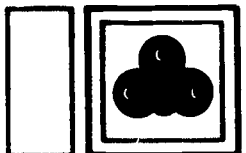

Instrument — instruction films. These films show the student the details of construction and operation of an instrument, as well as some of the basic laboratory techniques and safety precautions pertinent to its successful use. In practice a cartridge-loading projector containing the film is placed beside the instrument in the laboratory. A student views the film or portions of it any time he feels the need. With such films, the usual check-out period for an instrument (e.g. UV, IR, nmr, Raman, etc.) can be greatly abbreviated or eliminated. Examples of instrument instruction films now available or in preparation are given in Table F-4. (See page 21.)

Laboratory examinations via films and tapes. Films and tapes offer two significant breakthroughs in laboratory examinations. First, they allow the instructor to move toward laboratory examination. Secondly, they allow him to evaluate student learning and understanding of various parts of the experiment. Such evaluation may be used either for grading purposes or for approval to proceed to a situation of greater complexity.

Items which have been used or suggested for filmed or taped laboratory examinations include: 1) the prediction of the effects of changing various experimental parameters; 2) the design of an experiment to test a hypothesis; 3) the formulation of an hypothesis from the evidence presented; 4) the ordering of data; 5) the design of experiments to achieve a specific objective; 6) the determination of knowledge of experimental tools; 7) specific observations; 8) the surveillance of errors in technique; and 9) the identification of laboratory operations and equipment.

In addition to films, slides and transparencies also have been used as mechanisms for administering laboratory examinations.

Films for non-scheduled time. Some instructors assign a given film for out-of-class viewing prior to the consideration of the topic in the class, just as they would make an assignment in the textbook. The film treatment of the subject then serves as the basis for the class discussion.

In selected cases, solutions to problem sets and examinations are available on slides or film strips. Synchronized sound techniques may be



The reaction of xenon with platinum hexafluoride. Photographed from the color film "Xenon Tetrafluoride," produced by Argonne National Laboratories.

used to explain the solutions to the problems and questions. This may also be done for sample calculations from experiments.

Another technique is to put the lectures on audio-tape or on film with sound. In such instances, students absent from lecture and those wishing to clarify their understanding of class material may do so. Such out-of-class viewing programs have been operated in one of two ways: 1) space is provided within the department for the projection and listening devices; 2) instructional materials are available through an audio-visual center. In such facilities a student may be able to dial and see any of a variety of films stored in the audio-visual center.

Coordinated use of different film and tape materials. Several instructional experiments now are underway which make available to the instructor in his classroom or to the students in laboratory-study carrel combinations the capabilities of several media — films, sound TV tape, overhead projector.

One of the most successful of these is the audio-tutorial laboratory developed by S. N. Postlethwaite in the Botany Department at Purdue. In this laboratory, the student has at his disposal in addition to the usual botany laboratory facilities, study carrels containing film projectors and audio tape recorders. Each student

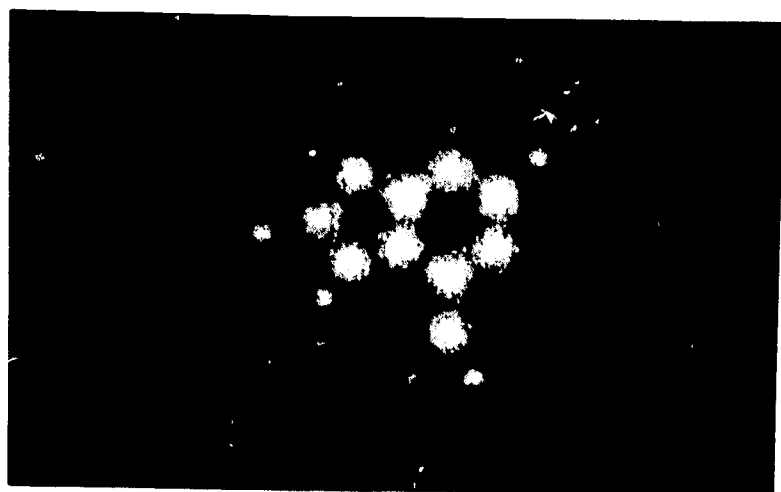
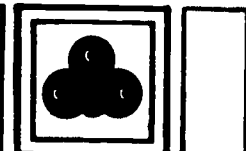

An electron density map of molecular structure and a field emission microscope picture of a platinum crystal. Photographed from the color film "Electronic Processes in Crystals" produced by Tokyo Cinema, Inc.

comes to laboratory when he wishes and while there proceeds at his own pace.

In the study carrel, the student listens to audio tapes specially prepared by the instructor for the unit or experiment under study. Instructions on the audio tape may direct the student to the laboratory bench or to view a film also prepared especially for this use, or to a reading assignment. If a student needs help, he can approach an instructor on duty in the laboratory

for this purpose. Each student gauges his own progress with quizzes which either send him forward to new materials or back over some of the same material. A chemistry program similar to this is now in progress at Cornell.

Many schools now have lecture rooms equipped with facilities for slide, film, TV and overhead projection. Instructors can control any of these from the lecture table or may use any combination in a given lecture. One technique frequently used in these classrooms is to display related information on two screens simultaneously. The instructor then shows the relationships or draws comparisons between the information appearing on the two screens.

Ancillary materials for films and tapes. Because students often do not take notes during a film or tape presentation, many instructors have found it especially helpful to prepare study guides or quizzes which students may take with them. Making these materials available for study before viewing the film sometimes helps a student become more alert to the important concepts presented and may encourage him to search for answers to questions as he views the film.

Teachers preparing films for distribution are urged to supply resource guides for these films. In this way potential users can know the purpose and content of a film and may gain information that will enable them to use it more effectively.

Filming techniques. Many of these techniques have been used effectively in chemistry films as the examples in Table F-5 illustrate. These examples should prove particularly useful to those planning to make their own teaching films.

TABLE F-5

Examples of Various Film Techniques in Chemistry Films	
Technique	Some Uses in Chemistry Films
Time-lapse or Time-expansion	crystal growth, chemical equilibrium, chemical kinetics, dissolution, diffusion, corrosion
Magnification	crystal growth, crystal structure, electron photomicroscopy, reading of instruments
Animation	dissolving a salt, molecular vibrations, electrolysis, chemical and physical equilibrium, mechanisms of reactions

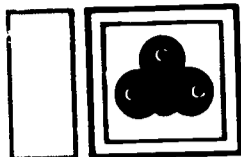

SOURCES OF CHEMISTRY FILMS

In the past no concerted effort has been made to produce a carefully-edited catalogue of existing chemistry films with useful reviews. Hopefully such a catalogue will be available during the next year.

Film Directories

1. Index of Chemistry Films (Fourth Edition)

Royal Institute of Chemistry
30 Russell Square, London W.C.1, Eng.

This index is the most comprehensive listing of films on chemical topics currently available. Approximately 1400 films and 400 filmstrips from more than 200 sources are included. The fourth edition lists films produced through September 1964. Designed for use by schools, technical colleges, universities and the training departments of industrial firms, this index includes offerings from the USA, United Kingdom and 20 other countries. It contains 127 film subject classifications and 77 film strip classifications and costs approximately \$1.10 prepaid.

2. Film Guide on Chemicals, Chemistry, and the Chemical Industry, 1965-66 Edition

Manufacturing Chemists' Association, Inc.
1825 Connecticut Avenue N.W.
Washington, D. C. 20009

List contains 311 films from 100 sources covering many facets of chemistry, chemicals and the chemical industry, and suitable for many audiences including college students.

3. United States Atomic Energy Commission 16 mm Film Catalog, Professional Level, 1965

Audio-Visual Branch
Division of Public Information
U.S. Atomic Energy Commission
Washington, D. C. 20545

186 professional-level technical films are made available from ten domestic USAEC film libraries on a free loan basis for educational, non-profit, and non-commercial viewing. Listing includes title, date, time, sound, color, producer, sale and loan information plus a comprehensive paragraph summary of the subject content of the film. "Understanding the Atom Series", and the "1964 Geneva Film Series" are available from this source.

4. Argonne National Laboratory Catalogue of Motion Picture Films

Film Center, Bldg. 2
Argonne National Laboratory
9700 So. Cass Ave., Argonne, Ill. 60440

List contains 92 films produced by and for the Argonne National Laboratory covering topics ranging from the general nature of the Argonne Laboratory to specific experiments recorded for highly trained experts. Films are available on loan at no charge (other than return postage and insurance). Listing includes title, catalogue number, date, time, sound, and color information plus a paragraph summary of the subject content of the film.

5. Films on The Nuclear Sciences (1966 catalogue)

National Science Film Library
Canadian Film Institute
1762 Carling Avenue
Ottawa, 13, Ontario, Canada

Summaries of 254 films are available from the Canadian National Science Film Library. Information is given on each film including country and production date, length, whether black and white or color, language versions available, producer and sponsor, technical or scientific adviser, description of content, and service charge or rental. The sections on general theory and principles, chemistry and metallurgy, and radiation and radioisotopes contain details on many films suitable for use in colleges and universities.

6. Bureau of Mines Films, 1965-1966

MOTION PICTURES
Bureau of Mines

4800 Forbes Ave., Pittsburgh, Pa. 15213

Tabulation includes information on 40 films with many relevant to the technological aspects of chemistry. These films are available from the Bureau of Mines without charge except for return postage. List includes information on film title, time, mailing weight, producer of the film, and a summary of the film content.

7. Source Directory: Educational Single-Concept Films Available in Magi-Cartridges (Third edition, March 1966)

Commercial and Educational Division
Technicolor Corporation

Box 517, Costa Mesa, California 92627

This is a current list of educational film producers and respective listings of single-concept films available in Magi-Cartridges for use in Technicolor Standard 8mm and Super-8 Instant Movie Projectors. It includes 66 titles on chemical topics available from seven sources.

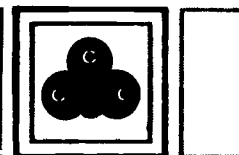

Other Film Sources

Several series of films, film strips, and transparencies have been prepared for the chemistry classroom and are not completely reported in the directories just described. Most of these films have been prepared for beginning chemistry classes or for the in-service education of secondary school teachers.

Motion Pictures with Sound

1. Modern Learning Aids

Division of Modern Talking Picture Service, Inc.

3 East 54th Street, New York, N. Y. 10022

This source offers 26 CHEM Study Chemistry Films (available in both 16mm and 8mm sound cartridge formats). In addition 11 films on chemistry laboratory techniques (available in 16mm), and three films titled "The Chemical Elements" (available in 16mm) are offered.

2. Coronet Films

Coronet Building, Chicago 1, Illinois

Coronet offers the University of Akron Chemistry Laboratory Series (available in 16mm form), consisting of twenty-seven films and the Coronet Chemistry Films set (available in 16mm form), a series of twenty-one classroom films.

3. Encyclopedia Britannica Films, Inc.

1150 Wilmette Avenue
Wilmette, Illinois 60091

The Chemistry on Film Series (available in 16mm form) consisting of one hundred sixty films is offered.

8mm Film Loops, Short Form, Silent

1. Advisory Council on College Chemistry

Teaching Aids Committee Film Project
Chemistry Department, Stanford University
Stanford, California

Approximately 10 films have been produced at Oregon State University by W. H. Slabaugh illustrating what a chemist with ideas and a minimum of equipment can do to produce 8mm film loops designed for use in the college classroom. Approximately 10-single concept films have been made by J. A. Campbell by extracting relevant footage from CHEM Study films. Five single concept films have been made by S. A. Schrage by excerpt-

ing footage from existing films. These films are available only for examination and stimulation purposes at the present time.

2. United Nations Educational Scientific and Cultural Organization

Pilot Project for Chemistry Teaching in Asia
Division of Science Teaching, UNESCO
Place de Fontenoy, Paris 7e, France

Approximately 10 films, generally dealing with experimental topics treated in an "open-ended" manner have been made. Some emphasize the continuous variation methods developed in the Chemical Bond Approach.

3. The Nuffield Foundation

Science Teaching Project
Mary Ward House

Tavistock Place, London S.C. 1

Thirty-eight films have been prepared to supplement the new "O" level (secondary school) chemistry course development by Nuffield; this list includes loops on laboratory techniques, theoretical concepts based on experimental observations, measurement, industrial processes and uses of chemicals.

4. Association Films, Inc.

600 Madison Ave.
New York, N. Y. 10022

Sixty-three chemistry films produced at Yale University are available with seven showing demonstrations on the preparation of oxygen, six showing demonstrations related to physical and chemical changes, and twenty-two on miscellaneous topics including laboratory techniques, basic principles, and structure.

5. Genco Educational Films

1800 Foster Ave., Chicago, Illinois 60640
Five films related to the detection and effects of nuclear radiation are offered.

6. Encyclopedia Britannica Films, Inc.

425 North Michigan Avenue
Chicago, Illinois 60611

Five films related to states of matter and properties of matter and eight describing laboratory techniques in chemistry are available.



7. Sutherland Educational Films
201 N. Occidental Blvd.
Los Angeles, California 90026
Four films on some fundamental chemical concepts are listed.
8. Gateway Educational Films Ltd.
470-472 Green Lanes
Palmer's Green, London N. 13, England
Three films on paper chromatography, thin-layer chromatography, and electrophoresis are offered.
9. Halas and Batchelor Cartoon Films, Ltd.
Lysbeth House
10A Soho Square
London, W. 1, England
Eight films on atomic and molecular structure are scheduled to be released in 1966.
10. International Visuals Aids Center
691 Chaussee de Mons
Brussels 7, Belgium
Sixteen films on technological topics related to chemistry have been made.

Transparency Sets

1. John Colburn Associates, Inc.
P.O. Box 1236
1122 Central Ave.
Wilmette, Illinois 60091
Tecnifac Overhead Projecturals offer a general chemistry set of fifty-nine projecturals (with overlays) and a 48 page teacher's guide.
2. Keuffel and Esser Company
Hoboken, New Jersey
Spectra transparencies for the overhead projector for chemistry are offered. This is a set of eighty transparencies (with overlays).
3. General Aniline and Film Corporation
140 West 51st St.
New York, New York 10020
Projecto Aid Transparencies consisting of a chemistry set of five transparencies are offered.

2 x 2 Inch Color Slides

1. Geographical Slide Service
845 Outer Drive
State College, Penna. 16801
Slides on minerals and manufacturing subjects are available.
2. American Museum of Natural History
Central Park West at 70th Street
New York, N. Y. 10024
Slides on snow crystals, common rocks, and minerals are available.

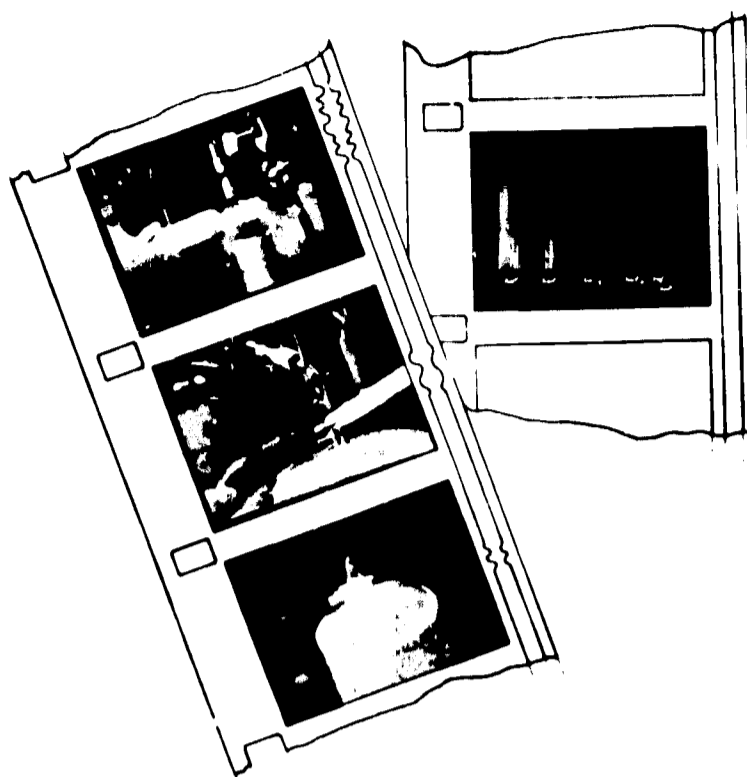

Apparatus used in the preparation of xenon tetrafluoride with a photograph of the oscilloscope trace of the product identification in the mass spectrometer. Photographed from the color film "Xenon Tetrafluoride" produced by Argonne National Laboratories.

EQUIPMENT: ITS AVAILABILITY AND USES

Basic to the renewed interest in using film in the chemistry classroom and laboratory is the introduction by the industry of unproved film, film formats and complementing hardware. With these new developments comes an increased need for the chemistry teacher to understand not only the capabilities of the new hardware but also some of the important principles of projection. Included in this section is information on film formats, projectors and their characteristics, sound screens and some new developments in still projection techniques. The aim here is to provide a handy guide for the purchase and the setting up of equipment so that the best results can be obtained.

Film types. There are currently four forms of 8mm motion picture films on the market in addition to the traditional 16mm format. These are the regular 8mm, Super-8, Format M and a Japanese product. Of these the regular 8mm and the Super-8 have been used most extensively in teaching films.

The image area on the Super-8 film is 52 percent larger than that of the regular 8mm. Consequently the Super-8 format offers a brighter and sharper picture than that obtained from a



regular 8mm material under comparable conditions. Both regular 8mm and Super-8 can give magnetic sound prints with a quality comparable to present 16mm optical sound. Because the sprocket holes are smaller and further apart on Super-8 film than on regular 8mm film, each of the 8mm formats requires its own projectors and cameras. However, several manufacturers offer equipment which can be converted from regular to Super-8 with minor adjustments.

The running time of the 8mm films is approximately twice that of the 16mm. For example at silent speed (18 f.p.s.) 100 feet of 16mm film will run in about 4 minutes while only 50 feet of regular 8mm film will run in about the same time.

Projectors. Table F-6 gives some examples of film projectors, their important characteristics and manufacturers.

TABLE F-6

Typical Film Projectors, Their Characteristics and Manufacturers			
8mm Front Screen	Cost	Fairchild Mark IV (cartridge load sound)	Cost
Technicolor Model 500 (cartridge load silent). Technicolor Corp., 1985 Placentia Ave., Costa Mesa, Calif.	\$ 85.00	Super 8-mm, Rear Screen Not available as single unit; must be a combination unit; see page 29.	\$495.00
Fairchild Mark V (cartridge load sound).		16mm, Front Screen	
Fairchild Camera and Instrument Corp., Industrial Products Division, 750 Bloomfield Ave., Clifton, N. J.	\$560.00	¹ Bauer P-6 Auto load, quartz I, bulb magnetic and optical sound.	\$1250.00
Bolex 18-5, Auto load, silent	\$164.50	² Bell and Howell Auto load 552	\$755.00
Super-8mm, Front Screen		Bell and Howell 302-M magnetic sound	\$950.00
Technicolor Model 510. (cartridge load, silent). Technicolor Corp., 1985 Placentia Ave., Costa Mesa, Calif.	\$ 99.50	³ Graflex Model 815 manual threading	\$625.00
Eastman Kodak M-90 Reel load, silent. Eastman Kodak Co., Apparatus and Optical Div., 343 State St., Rochester, N. Y.	\$189.50	⁴ RCA Safethreader No. 1600	\$617.00
Eastman Kodak M-100 Reel load, sound. Eastman Kodak Co., Apparatus and Optical Div., 343 State St., Rochester, N. Y.	\$575.00	⁵ Eastman Kodak AV105mm magnetic sound	\$995.00
Bauer T1-S, Quartz I, bulb auto load, sound can be added to laboratory tape recorder	\$179.50	⁶ Victor Mag-3 magnetic sound	\$670.00
8mm, Rear Screen		Special Purpose Projectors	
Technicolor 600 console viewer (cartridge load silent)	\$199.50	Magnetic Sound Technicolor Model 800 projector No. TMT - 25 telecell	\$270.00
		Kalart Soundstrip 35mm optical sound filmstrip. The Kalart Co., Inc., Hultenius St., Plainville, Conn.	\$400.00

¹ Allied Impex Corp., 300 Park Ave., New York, N. Y.
² Bell and Howell Photo Sales Co., 7100 McCormick Rd., Chicago, Illinois
³ Graflex, Inc., 3750 Monroe Ave., Rochester, N. Y.
⁴ RCA-Radio Corp. of America, Inc., Front and Cooper Sts., Bldg. 15-8, Camden, N. J.
⁵ Eastman Kodak, Rochester, New York
⁶ Victor Animatograph Sales, Div. of Kalart, Hultenius St., Plainville, Conn.

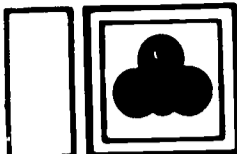

8mm front (wall) screen projectors. The home variety of projectors which utilize regular 8mm film generally are not suitable for front screen projection in classrooms. The Bolex Model 18-5 (\$200.00) is an example of a high quality projector which has been used successfully for this purpose. Among the cartridge loading projectors, the Technicolor Model 500A offers an inexpensive regular 8mm projector (\$85.00) with still picture capabilities, without sound. This projector takes a four-minute cartridge. The manufacturer indicates that it will give a satisfactory 30" by 40" image in a darkened room on a wall screen. It has been used for front screen projection in small areas under carefully controlled conditions.

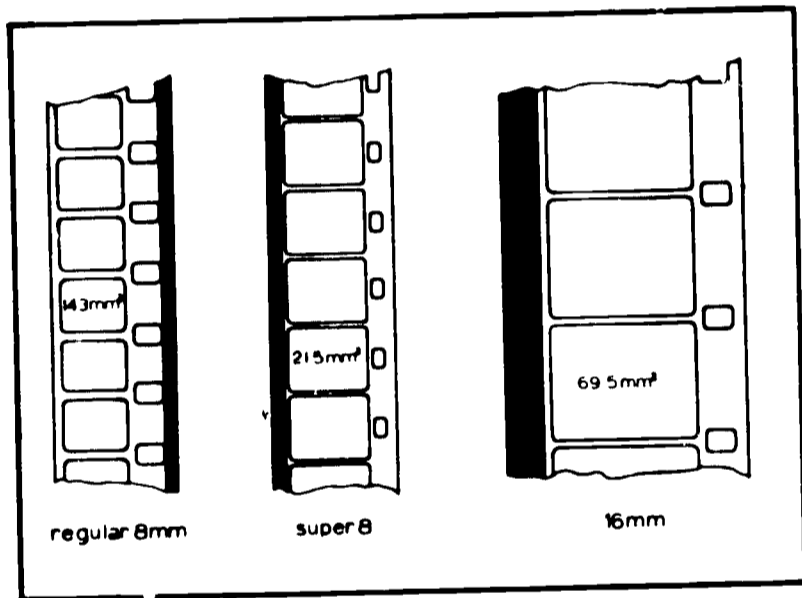

A comparison of regular 8mm, Super 8mm and 16mm film formats. The shaded areas indicate the space available for the sound tracks.

Super-8mm front screen projectors. Here the teacher has a choice of supporting models with improved light sources and lenses. The Eastman M-90, reel type (\$180) or the Bauer (\$179.50) are examples of Super-8mm projector design. The Eastman M-100 projector has magnetic sound capabilities, and, in operation, offers suitable performance in the small classroom. It is comparable in price to 16mm sound projectors. The Technicolor 510-A (\$90.00) is the only Super-8 cartridge load projector on the market at present. It has no sound capability and takes a four-minute cartridge.

16mm front screen projectors. Considerable improvements have been made in loading characteristics and light output of 16mm sound projectors in recent years. These improvements fa-

cilitate immediate classroom use of films and film segments. The simplified operation, and improved picture, will be of interest to those who have not examined the new models. Auto-loading characteristics are such that the inexperienced instructor or teaching assistant can get a picture on the screen in a matter of seconds with an absolute minimum of training. Examples of this equipment include:

Bell and Howell Autoload Model 552	\$ 755.00
RCA Safethreader Model 1600 "Safethreader"	\$ 617.00
Graflex Model 815 (manual loading projector)	\$ 625.00
Bauer P-6 Autoload, incadescent or quartz I ₂ projection bulbs available	\$1250.00

The following projectors offer a combination of optical and magnetic sound reproduction features. They also have a feature which permits the user to add his own sound track to the film (magnetic recording feature).

Bell and Howell Filmsound 302 M	\$950.00
Eastman Kodak Model AV-105M	\$885.00
Victor Mag-3	\$670.00

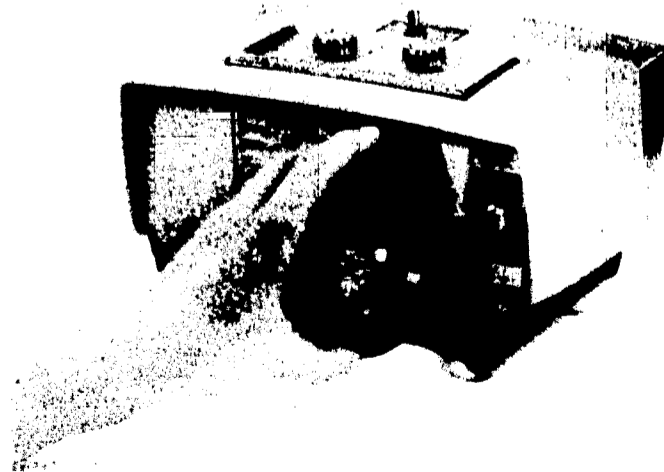

A Technicolor projector and film cartridge.

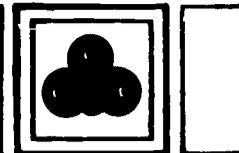

Sound conversion units are available to provide magnetic sound recording and playback capabilities for existing equipment. The Gregory Sound Conversion Unit sells for \$195.00 plus installation. For a discussion of magnetic and optical sound, see below.

8mm rear screen projectors. A self-contained rear screen and projector for 8mm film resembles a small television set. The advantage of rear screen projection is that it can be used in the normally lighted laboratory or classroom. Current model projectors take cartridge film. They are extremely simple to operate requiring a minimum of maintenance. The only projectors of this type now offered in the regular 8mm size, are the Technicolor Model 600AD (\$250.00) and the Fairchild Corporation Mark IV projector (\$495.00). The Technicolor projector uses a four minutes cartridge; the Fairchild projector takes a cartridge which holds up to 22 minutes of color film. Magnetic sound is a standard feature with the Fairchild projector. Color prints of the CHEM study films are available in cartridges for Fairchild projectors. One model of the projector is equipped with a magnetic recording feature (model IVAV).

16mm projectors for rear or front screens. The Kalart-Victor projectors use regular 16mm film in combination which provide both front and rear screen projection capabilities.

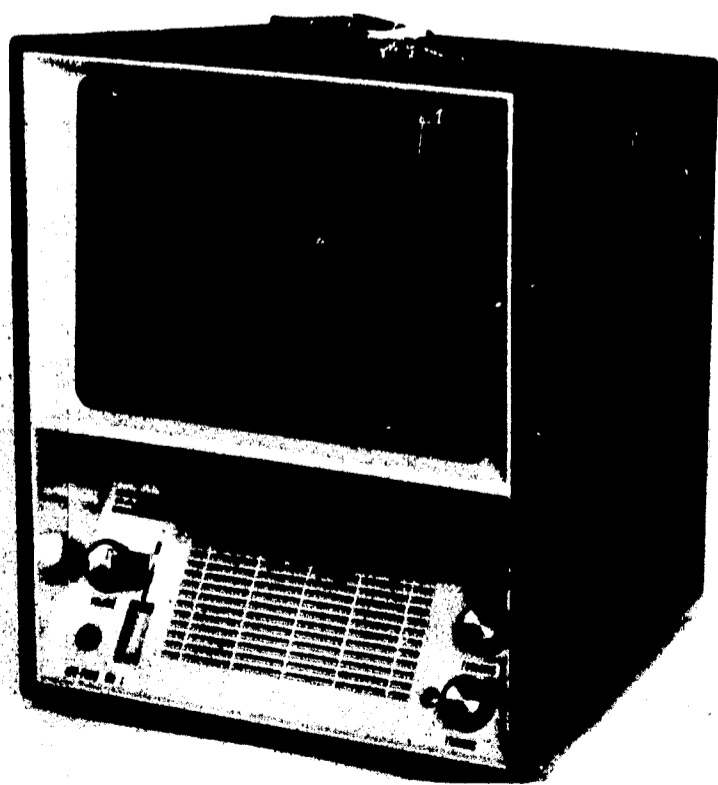

A Fairchild projector and film cartridge

Light sources. The General Electric Mark 300 high intensity light source, available in many new projectors, so increases illumination on the screen that film can be shown under normal classroom lighting conditions.

When considering the purchase of new projection equipment which might be used in a large lecture hall, suppliers should be given the room dimensions, lighting conditions and other features in addition to the projector capabilities desired. All such equipment should be tested in the rooms in which it will be used before a purchase is made.

Rear screen projection cabinets. Good commercial rear screen projection cabinets are available for use with a variety of projectors running from 35mm slide to 8mm and 16mm movies. The Hudson Photographic Industries 8mm screen (\$17.00) and the H. Wilson Corp. 16mm screens (\$150.00) are examples. For the "do-it-yourselfer," the Eastman Kodak Pamphlet No. S-29 REAR PROJECTION CABINETS offers excellent directions on local fabrication.

Sound characteristics of film. Conventional 16mm sound film has an optical sound track in which the sound reproduction is stimulated by light. Films now can be supplied with magnetic sound tracks. Here the sound reproduction is stimulated by the interaction of a magnetized stripe on the film with a charged head in the projector. The magnetic sound stripe similar to that on an audio type can be added to film prior to photographing. Sound can be recorded as the film is exposed in the camera, or it can be added later using projector with a magnetic recording capability. Eastman film, Kodachrome II No. KA558, can be ordered now from dealers. A camera suitable for this use is discussed on page 31. Probably more important to the teacher is the fact that 8mm, Super-8 and 16mm film can be shot silent and the magnetic stripe added when the film is processed. This affords the opportunity of adding a sound track to the film as it is run through the projector. Magnetic striping makes it possible to add a second sound track to films with sound. Magnetic sound tracks can be erased and corrected as with an audio tape recorder.

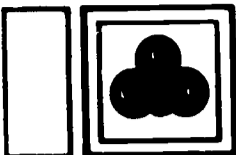

TABLE F-7

Costs of Silent Color Positive Prints and Addition of Magnetic Stripes				
No. of Prints Ordered	Size Negative Substrate	Total Cost per 8mm ft.	Addition of Sound Strips	Addition of Sound from 16mm Negative
Regular-8 or Super-8 1 2-9 25 up	16mm	12-18¢	3-16¢	11-24¢
		8-15¢	3-13¢	
		6¢	8-9¢	3-11¢
Regular-8 or Super-8 1 2-9 10-24 25-49	Super-8	17¢	NA	NA
		17¢	NA	NA
		NA	NA	NA
		NA	NA	NA
16mm 1 2-9 10-49 100 up	16mm	Total Cost per 16mm ft. 19-22¢		(Only recommended source: Eastman Kodak; write for prices and details on Sona- track coatings)
		11-22¢		
		11-16¢		
		5.4¢ (With Magnetic sound)		

Prices do not include costs of internegative, printing effects, prints from A and B rolls, minimum charges, or discounts to schools. Contact the laboratories for specifics.

TABLE F-8

Some Laboratories Offering 8mm Release Print Service		
The Calvin Company 1105 Truman Road Kansas City 6, Missouri	George W. Colburn Laboratory, Inc. 164 North Wacker Drive Chicago 6, Illinois	Hollywood Valley Film Laboratories 2704 West Olive Avenue Burbank, California
Cine-Chrome Laboratories 4075 Transport Street Palo Alto, California 94030	De Luxe Laboratories, Inc. 850 Tenth Avenue New York 19, New York	Technicolor Motion Picture Corp. 6811 Romaine Street Los Angeles 38, California
Cine Magnetics, Inc. 262 East 44th Street New York 17, New York	General Film Laboratories Corp. 1546 N. Argyle Hollywood, California	Western Cine 312 So. Peel St. Denver, Colo. 80202
	Hollywood Film Enterprises, Inc. 6060 Sunset Boulevard Los Angeles, California	

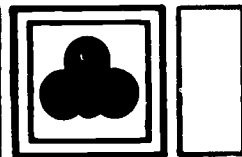

Inquiries concerning magnetic striping processes and costs should be directed to the film processors.

Film costs. For those planning to make their own films, Table F-7 gives approximate current costs for the printing of silent color films and for addition of magnetic sound stripes. Table F-8 lists some laboratories offering release print service.

Cost of cartridge films. Cartridge costs range from one to ten dollars (based upon the kind of projector and on the quality ordered). Technicolor Corporation now will furnish and load cartridges for their projectors at a cost of \$1.00 when suitable 8mm film is furnished. Cartridges for the Fairchild projectors cost from \$6.60 to \$9.95 and special film treatment for films longer than 200 feet is necessary at a minimum cost of \$4.00. Those desiring to have films put in cartridges are encouraged to contact the Technicolor or Fairchild Corporations directly.

Cameras and lenses. Accompanying the introduction of the new film formats and projectors are improved cameras. Cartridge loading of cameras with Super-8 film is simplified since the cartridge need not be turned when half the footage film has been exposed. Zoom lenses permit going from a wide picture to a close-up and vice-versa without stopping or moving the camera. Reflex cameras with "through-the-lens" capability allow precision composing and focusing of close-ups. For photographing close-ups of laboratory equipment or reactions, cameras with a retail price of \$75.00 or less probably will not give acceptable steady picture quality.

Two professional cameras which are available for 8mm film are the Bolex H-8 (\$480.00), and the Pathe DS-8 (\$900). The latter is the first camera to use a 100 foot double Super-8 film spool. The Fairchild Model 900 (\$900) is now on the market as a regular 8mm sound motion picture camera.

Plastic lenses are excellent for some uses; however, experience has shown that glass lenses are more suitable in close-ups for chemistry uses. Cameras with fast lenses (aperture not greater than f/1.9 and able to accept accessory close-up lenses are a necessity for quality film makeup. Slower lenses restrict camera use in

the usual low light situations encountered in the laboratory.

Still projection systems. Several new still projection systems which have appeared recently are described in the following paragraphs.

Filmstrip with magnetic sound. The Execu-gram (\$375.00) uses a film and a sound cartridge: the film cartridge contains up to one hundred 35mm pictures, and the continuous loop sound tape cartridge has a running time up to twenty minutes. This projector has both the front and rear view facility.

Filmstrip with optical sound. The Kalart Sound strip projector (\$400.00) uses a continuous strip of film identical with a sound movie except that the picture and the accompanying sound track are printed on alternate frames. Pictures, or slides with accompanying narration on audio tape can be sent to the manufacturer for conversion to this format.

Slides with sound. The Hughes Video-Sonic (automatic control) projector Model 901 (\$400.00) is a self contained rear screen projector which accepts 35mm slides in 36-slide trays. It has magnetic tape for audio.

Audio attachments for slide projectors. In many cases it is possible to use existing equipment, or combinations of projectors and recorders, to generate automatic presentations of slides and sound. The Kodak Carousel Sound Synchronizer (\$20.00) enables the instructor to combine a stereo tape recorder of any type with a Carousel Model 700 or Model 800 projector. Slide-change signals are recorded on one channel and the narrative on the other track. On playback, slides change automatically; this system is easy to connect and use.

A synchronized sound-film system. This is available for the Technicolor Model 800 Projector, from Ealing Films or Auto-Sell, Inc. (\$255.00 for projector and recorder). Both tape and film automatically stop when the end of the film loop is reached. It is possible to program the film loop for double or triple showing, using up to 20 minutes of narration.

Special effects. The Kodak motion adapter unit (\$24.00) consists of a spinning polarizer which fastens on the front of any 35mm projector lense and requires especially made slides which

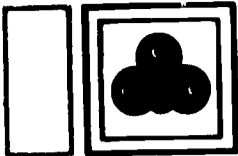

contain elements of polarizing material. An effective motion illusion is possible including continuous or cyclic movement, rotation, vibration, and radiation. Technical Animations, Inc. can prepare motion slides on a custom basis. The American Book Company will be the distributor for motion slide series. Eastman Kodak, Audio-Visual dealers, will handle orders for slides. Experimental kits of Technical Animation polarizing materials are also available from the dealers. Prototype slides showing vibration modes of molecules now are available.

Random access slide projector. One of the disadvantages in using slides to augment lectures has been that the lecturer is tied to an order of projection not easily changed. This disadvantage is overcome with the appearance on the market of random-access, 35mm automatic slide projectors, such as the Dial-A-Slide projector (\$700.00) or Eastman Kodak RA-950 projector (\$785.00). Both projectors have controls which tell the instructor which slide is being projected. Similar units are available for connection to data retrieval systems.

UTILIZATION OF PROJECTED MATERIALS

Regardless of the quality of a motion picture film or slide, or the advanced state of the art in hardware, successful projection techniques remain the key to transferring ideas and concepts from the projected image to the students' mind. By following good practices in setting up a classroom or laboratory for the showing of film, the instructor gains the ultimate flexibility for utilizing a slide or film clip in the lecture with the confidence that the class will receive the maximum benefit from the medium.

This section is intended to help clarify some of the steps necessary to insure that the message reaches the class without interference by the projection process.

For effective projection in the classroom, consideration should be given to the following:

- selection of a screen location, size, and type.
- selection of the optimum projector location.
- providing required image brightness.

*Most of the information on screens was taken from Eastman-Kodak publications.

- general considerations of student comfort in the lecture room including light control, adequate sound facilities, and seating.

For the optimum use of projection during a lecture there should be a minimum of equipment and facility adjustments. For all practical purposes, the screen should be in a fixed position away from direct light sources and from areas used more frequently, e.g., avoid if possible a screen location where a roll-down screen covers the chalkboard.

Under ideal conditions, the instructor should be able to push a button and insert into the lecture a film or slide for seconds or minutes as needed, with absolutely no mechanical distractions to the class.

*Projection screens.** The screen is most often the weakest link in using the projection systems. The efficiency with which the screen can transmit color brightness and contrast to the eye, affects the ease with which the point being made can be understood by the student. Following are brief discussions of screen types and their suitability to classroom or laboratory applications:

Matte screens. Matte screens diffuse light evenly in all directions. Images on matte screens appear almost equally bright at any viewing angle. To avoid distortion because of viewing angle, however, viewers should be no more than about 30 degrees to the side of the projection axis, and not closer than two-image widths to the screen.

Most matte screens are about 85% efficient. A metal finish matte screen will give valuable color correction to pictures where true rendition is important. A form of matte screen can be a smooth wall painted white, although it should be viewed critically before accepting it for classroom use.

Lenticular screens. These screens have a regular pattern of stripes, ribs, rectangles, or diamond shaped areas. The pattern is too small to see at viewing distances for which the screen is designed. The screen surface may appear to be enameled, pearlescent, granular metal, or smooth metal.

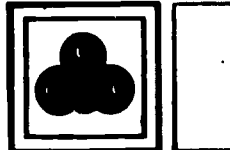

By control of the shape of the reflecting surfaces, the screen can reflect nearly all the light from the projector evenly over a fan shaped area 70 degrees wide and 20 degrees high. Many lenticular screens provide an image three or four times as bright as a matte screen.

Beaded screens. Beaded screens are useful in long narrow rooms or other locations where most viewers are near the projector beam. They are white surfaces with imbedded or attached small clear glass beads on silica chips. Most of the light reaching the beads is reflected back towards its source. Thus, a beaded screen provides a very bright image for viewers seated near the projector beam. As a viewer moves away from the beam, the image brightness decreases. At about 22 degrees from the projector beam, the image brightness on a beaded screen will be about the same as that on a matte screen. Beyond this angle it will be less bright than on the matte screen. Students should sit no closer than two and one half times the image width from a beaded screen.

Rear-projection. Rear-projection pictures have the same requirements for image brightness, size, and contrast as front-projected images. Rear projector screens are made of glass, plexiglass, or flexible plastics with one side of the screen a matte surface.

To reduce space requirements in rear projection, short focal length lenses sometimes are used. A single mirror between the projector and the rear screen is necessary; however large mirrors must be avoided. A special lens with a mirror encased and suitable for this purpose is available from Buhl Optics.

With most projectors, images as wide as 42 or 48 inches will be satisfactory on a dark rear projection screen in moderately lighted rooms. For larger images, a light screen in a darkened room is usually needed. In very brightly lighted rooms, images should usually be no more than 24 or 30 inches wide and the screen material dark.

Front vs. Rear Projection. In considering which projection system is best for given conditions, two common arguments regarding both systems are discussed below.

Shortened projection distances are claimed as an advantage by proponents of each system. While this is true in both cases, a short projection distance often does not give the image sharpness and brightness desired. However, when space is at a premium, short projection distances may be necessary and the equipment can be made to perform adequately.

Visibility in lighted areas also is claimed as an advantage by proponents of both front and rear projection. Either system will do a good job, *depending upon conditions*. When a small image (up to 3 feet wide) is desired, a dark colored rear-projection screen may provide dramatically better image contrast and color saturation than a front-projection screen. Although a rear-projection screen reduces image brightness, the amount of room light reflected toward the audience is reduced by an even greater factor. The back of the screen must be shielded from stray light. Front-projection screens always must be shielded from direct light.

When a large image (wider than 3 feet) is desirable, front-projection systems using a lenticular screen usually give better results than rear-screen systems. Location and control of room lights are important factors to consider here. In any case, more care must be given to the orientation of the projector, screen, and audience than is necessary for a smaller rear-projected image.

Screen Size. This should be such that the back row of viewers is no more than six times the image width (W) from the screen, with the following exceptions:

- a. Certain materials, including many teaching films, are designed with titles and important picture elements bold enough to permit satisfactory viewing at distances of 8 to 10 times the image width. When this is true for the materials to be projected, the projector may be moved closer to the screen to give a smaller and brighter image. Moving the projector enough closer to change the back row from $6W$ to $8W$ will approximately double the image brightness and allow the front row to be moved a little nearer the screen.

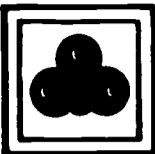

b. In some situations, materials which limit maximum viewing distance to less than 6W are commonly used. Typewritten material projected with an overhead projector is an example. For showing the full area of an 8.5 by 11-inch page, pica type calls for a maximum viewing distance of 3W. The teacher should *critically* test this for his particular situation, perhaps by taking the poorest seat in the classroom.

A discussion of screen size with excellent solutions to common puzzles is available in Eastman Kodak publication *Effective Slides S-22*, and *Legibility Standards for Projected Material, S-4*, and in the ACS publication, *How to Make Slides*.

Image brightness. Required brightness (the amount of light the student sees) depends on viewing angle; screen type; projector design, wattage, life rating, and age of lamp; character of material being projected; image size; line voltage; as well as on the design and cleanness of the optics. Lamp wattage alone gives little indication of image brightness. Using wattage as a measure of image brightness is comparable to rating an engine by the fuel consumed rather than the work done.

The effectiveness of a projector, expressed as image brightness, is defined in terms of lumen output. Lumen output divided by image area (in square feet) gives the foot-candles falling on the

screen from the projector. Foot-candles of illumination multiplied by the reflectance of the screen (about 0.85 for a good matte screen) gives in foot-lamberts, a measure of the brightness of the image seen by the viewer.

Thus, a projector with a 120-lumen output provides 10-foot-candles of illumination for a 3 by 4-foot (12 square foot) screen image; that is, 8.5 foot lamberts of image brightness for the viewer of a good matte screen. With a projector light output of 80 - 100 lumens, and a matte screen in a well-darkened room, an image 3 or 4 feet wide can be viewed easily. As a rough estimate of the image brightness required, there should be as many foot lamberts of light per square foot of screen as there are foot candles of light in the room. For a more detailed discussion of image brightness see Eastman-Kodak publication S-14 "What Can You Do With 100 Lumens?"

Projector location. Optimum projector locations depend upon a variety of factors including the lens and the screen size. Most manufacturers of projectors as well as lens suppliers (Buhl Optical Company) can provide a wide range of lenses for any type of projector. To decide on the lens needed for a given projector and situation, one should first determine the size of the screen to be used and then with the aid of a table such as Table F-9, the correct focal length for the lens can be calculated.

TABLE F-9

Determining Projection Distance, Image Width, or Lens Focal Length*

To determine the projection distance for a desired image width (or the image width for a desired projection distance), find in the following table the factor that applies to the film format and lens you are using. Then position a straightedge on the nomograph so that the edge passes through the points for the two known figures; read the third figure at the point where the edge passes through the other scale. For greater accuracy, add the focal length of the lens to the projection distance determined for a desired image or subtract the focal length from the desired projection distance when determining the image width.

To determine the best lens focal length, position the straightedge so that it passes through the desired image width and projection distance. Now read the figure that is nearest to the point where the edge passes through the left-hand ("Factor") scale and then consult the table to find the lens with the factor nearest to this figure. If screen size is a limiting element in the projection situation, choose the lens with the next larger factor.



Type of Material	Lens Focal Length (Inches)	Factor	Type of Material	Lens Focal Length (Inches)	Factor
16mm Motion Pictures (0.284" x 0.38" projector mask)	1 1/2	3.0	2 x 2" Slides (38mm square or 26.2 x 38mm horizontal mask)	3	2.0
	1 5/8	4.2		4	2.7
	2	5.3		5	3.3
	2 1/2	6.6		7	4.7
	3	7.9		9	6.0
	4	10.5	11	7.4	
Super 8 Motion Pictures (0.158" x 0.211" projector mask)	1.1 (28mm) Zoom (20 - 32mm)	5.2 3.7 - 6.0	Zoom (4 - 6)		2.7 - 4.0
8mm Motion Pictures (0.129" x 0.172" projector mask)	3/4	4.4	2 x 2" Slides (26.5mm square mask) (KODAK INSTAMATIC)	3	2.9
	7/8 (22mm) Zoom (15 - 25mm)	5.0 3.4 - 5.7		4	3.8
Filmstrip (17.2 x 23.0mm projected area)	3	3.3		5	4.8
	4	4.4		7	6.7
	5	5.5		9	8.7
	7	7.7	11	10.5	
			Zoom (4 - 6)		3.8 - 5.7
2 x 2" Slides (23 x 34mm horizontal mask)	3	2.3	Lantern Slides (Mask opening 3" wide)	6 1/2	2.2
	4	3.0		12	4.0
	5	3.7		16	5.3
	7	5.2		26	8.7
				9	6.7
			11	8.2	
	Zoom (4 - 6)	3.0 - 4.5	Overhead and Opaque (Material 10" wide)	14	1.5
				18	1.9

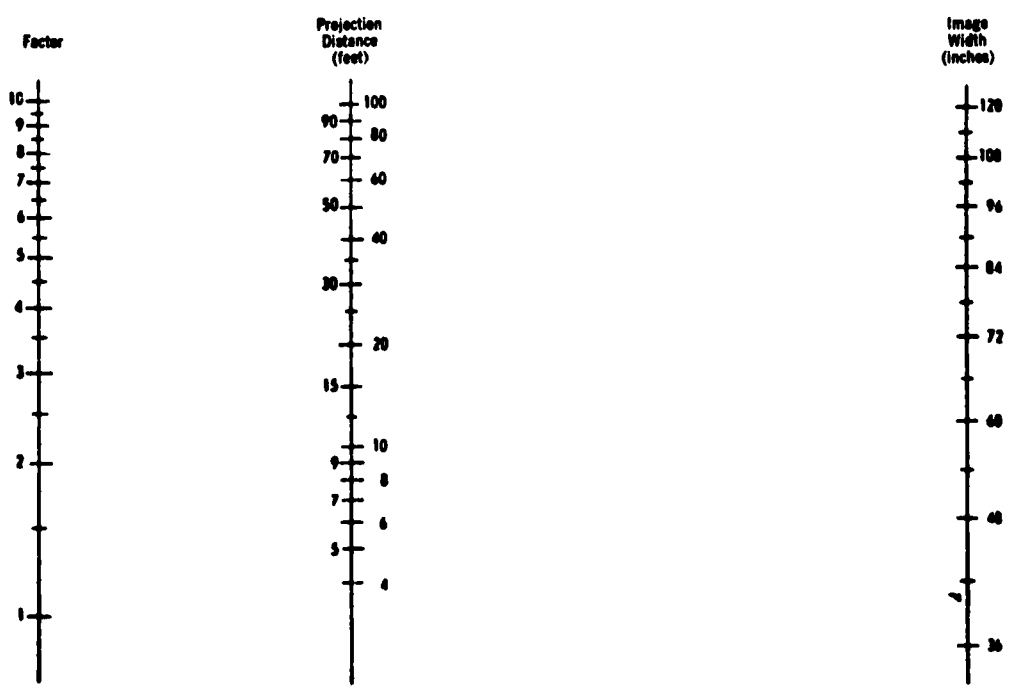

*Reproduced through permission of Eastman Kodak.

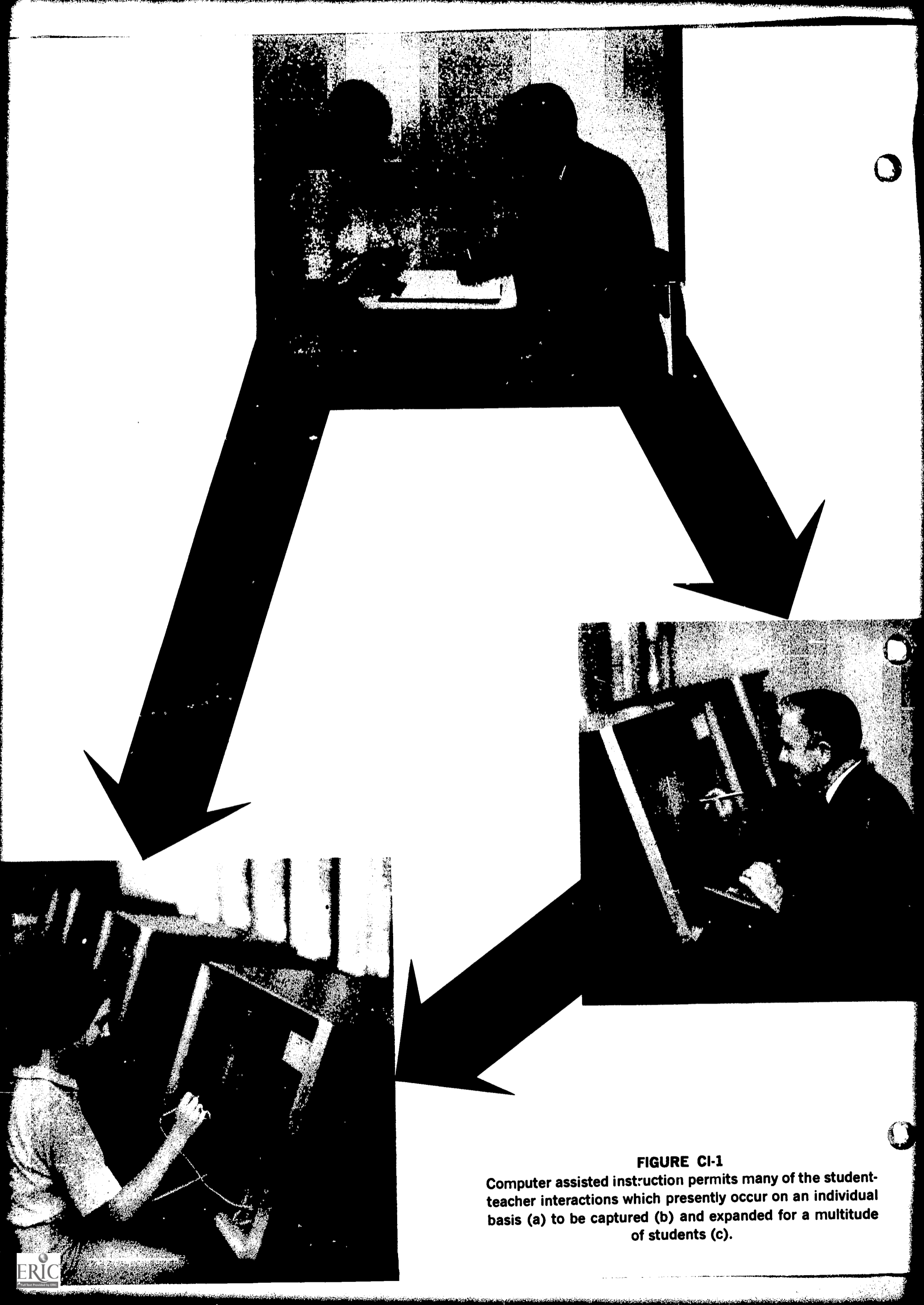
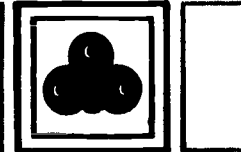

FIGURE CI-1

Computer assisted instruction permits many of the student-teacher interactions which presently occur on an individual basis (a) to be captured (b) and expanded for a multitude of students (c).



COMPUTER ASSISTED INSTRUCTION

Generally, the modern high-speed computer is considered to be an instrument used primarily in the solution of complex numerical problems or the processing of large quantities of data in standard ways. There have been many reports of the use of both digital and analog computers in chemical education. However, it is also possible to use computers to supplement teaching techniques. This report concerns itself primarily with these "non-classical" uses of the computer.

Computer assisted instruction (CAI) can be defined as a Socratic dialogue between a student and his teacher with a computer as an intermediary (Figure CI-1). In essence, the computer serves as a medium to capture the way a teacher approaches his subject. His particular point of view, his bias, as well as the pedagogical nuances he normally employs in teaching his subject, all these can be stored in the computer to be explored at will by one or by a hundred students.

EQUIPMENT

Basically, the computers used in CAI are very fast data retrieval systems which include (Figure CI-2), (a) a central data processing unit, (b) large capacity data storage units, (c) a transmission control (or traffic regulator) unit, (d) other peripheral devices which may be associated with the system but which need not be discussed at this point. The CAI system is designed to receive a set of sequenced instructions and perform them automatically. These instructions can be given to the system by either a typewriter communication unit or by standard punch cards. The former method is usually used by authors initially composing programs.

That part of the dialogue supplied by the computer is not limited to single words typed by a typewriter terminal under the "control" of the computer, although this is currently the predominant mode of presentation. It also may consist of slides or motion picture film illustrating the results of a laboratory investigation, an excerpt from a book, or any other material, restricted only by the imagination of the teacher who prepared the program and the capability of the hardware available to him (Figure CI-3).

Indeed, it is even possible to provide an audio statement by the computer, if required.

Since a computer is capable of making a series of decisions and initiating actions based on these decisions very rapidly, it is possible for a single data processing unit to handle more than one student terminal at once. At present, up to 32 students can interact simultaneously with one computer. The number of students is limited by the sophistication of the computer in which the program is stored. The capability of a given installation is not totally reflected by the number of time-shared terminals, since the latter can be scheduled for student use at any hour of the day. In addition, computer terminals need not all be placed in one location but may be situated in various convenient locations.

Student responses in the dialogue are not necessarily restricted to fixed phraseology since the computer can be instructed to search for key words in the students' portion of the dialogue. Mechanically, student responses may be either typed on a typewriter-communication unit, or the student can communicate with the computer by means of a light pen pointed at a specified portion of a cathode-ray tube.

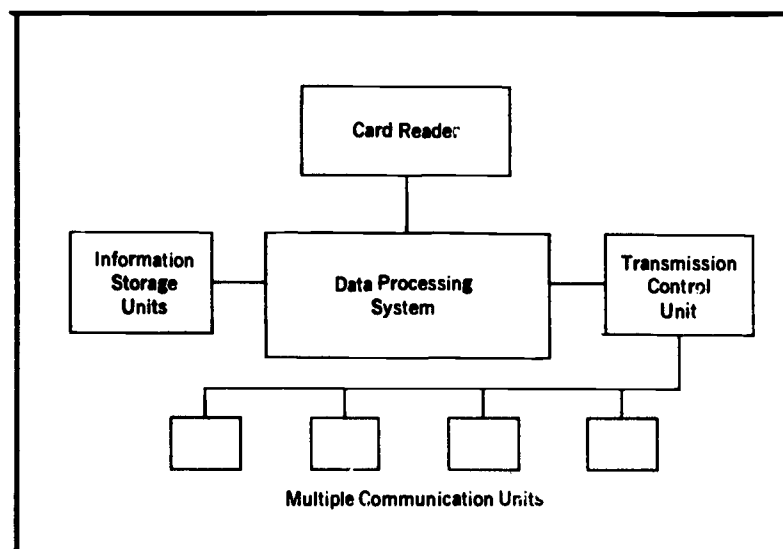

FIGURE CI-2
A conceptual diagram of the basic units which make up a typical CAI system.



FIGURE CI-3

A typical communications terminal for a CAI system. The computer can present information or questions to the student by means of a printed output or by visual displays (either on a cathode ray tube or with a slide projector) while the student may respond to the computer with a typewriter or a light pen.

In summary, the author of CAI material types his program into the computer, specifying information, questions, anticipated correct or wrong answers, and actions to be taken by the computer for a given student response. The program is constructed using standard operation codes. The computer stores the program and performs the operations designated when the student interacts with the CAI system. It is also possible for the system to provide a record of student responses which can be used by the author in refining the program.

At present, only the International Business Machines Corporation offers completely integrated CAI systems (1,2); however several specially designed installations exist which consist of central data processing units and associated equipment manufactured by a variety of companies (3). All of the major computer manufacturers are in the process of developing CAI systems. Persons interested in exploring the possibility of incorporating CAI techniques into their teaching should contact representatives of the firms that service the data processing equipment already available at their institutions, because of the very fluid situation which exists in the design and production of CAI systems. Also, it probably would be advisable to rent CAI

equipment rather than to purchase it outright since all of the units in a system are constantly being improved. For those persons interested in a more modest approach to CAI techniques, terminals connected to computers located as much as several hundred miles away can be rented.

PROGRAMS

The construction of a program for CAI is not difficult for a skilled, experienced teacher, though it is time consuming and has some tedious aspects. The techniques needed often are similar to those used in writing programmed instruction (4).

In essence, a program is prepared by constructing an imaginary conversation in the form of a flow chart (Figure CI-4) between a student and a teacher. The teacher must be continuously aware of *exactly* what he intends the student to learn in *detail* and of the guiding statements he would make to help a student whose responses suggest a misunderstanding. In the construction process, the teacher should assume that *typical* students will deviate from the flow of the subject in a variety of ways. The teacher, therefore, must compose a variety of corrective comments. Often these consist of a short dialogue with the student within the overall major dialogue. While the dialogue is being composed, code-word and format instructions to the computer are added. For example, the function "wa" in the Coursewriter language (5) specifies that the next following sequence of words is an anticipated *wrong answer* to a preceding question. This function causes the computer to compare the student's response to the question with the words which follow the symbol. If a match between the student response and the author's statement is obtained, the computer is directed to make an appropriate statement (or action e.g. change a slide). If no match is obtained, a different action is initiated.

Programs are entered into the computer by the author at a typewriter terminal. After suitable preliminary planning [such as constructing a flow chart (Figure CI-4)], it is most efficient to construct the program at the terminal from notes. Once the program is constructed, inser-

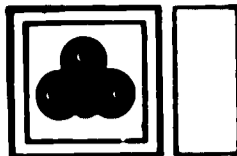

tions, deletions or modifications of almost any kind also can be incorporated into the program from the typewriter terminal. (See Reference 1, 2, and 3 for details concerning terminal configurations.) This procedure usually is necessary since the teacher's imagination and experience often are not sufficiently percipient to encompass all but the more common misinterpretations and outright errors a student will make when he is confronted by the program. Using a terminal in this way, the author can switch to "student" mode at will, testing out the logic and responses incorporated in the program as it is written. Several published examples of CAI programs are available (6).

The validity of CAI as a useful tool in teaching is perhaps best illustrated by an example. The flow chart in Figure CI-4 illustrates the application of CAI to a chemical topic. This chart shows a portion of the logic for a program which is to be used with laboratory work on colligative properties. The computer responses are given in the boxes with rounded corners and the student responses in the squared boxes. Inspection of this flow chart shows that a variety of pathways are available to the student as he proceeds through the program. It must be stressed that no attempt has been made in this flow chart to provide for equivalent or key word responses.

It should be noted that the statements (Figure CI-4) from the computer match the preceding responses of the student. In the construction of a program, it is necessary, in principle, to anticipate every possible response a student might make and to instruct the computer to present suitable statements (as determined by the teacher-program author) to any response made by an individual student. In practice, of course, this is impossible. Thus, in preparing a program, the teacher does the best he can to predict the several probable student responses to each statement in the program, and provides the corresponding statements which should be made to each response. In these cases, one is not concerned with the phrasing of the students' responses, but only with key words in the response which the computer identifies as the clue to the next statement that should be presented to the student.

Not all of the probable responses need be predicted, since the development of a good working program usually involves refinements based on student use. Even a typical student response can then be accounted for in constructing a generalized computer statement to follow the response. Further, it appears in most cases, that though the phraseology, or style, of student response varies, students tend to use a reasonably small number of different, usually synonymous, key words. Hence, with experience in the preparation of instructional programs, the difficulty in anticipating student response becomes lessened.

Since the only readily available language (5) for CAI programs does not commit the teacher to any particular teaching method, it is possible to incorporate a variety of teaching techniques permitting him to retain originality in his presentation. Thus the success of the program is limited by the ingenuity of the instructor. Programs can be written that essentially represent data retrieval systems in the worst sense of the word, i.e. a series of questions is asked by the computer and answered by the student with little interrelationships among successive questions and answers. Alternatively, the program can reflect a rich dialogue between a sensitive teacher and an inquiring student with the computer merely acting as an intermediary. It seems evident that program authors should also be competent, experienced, modern chemistry teachers, or at least such individuals should be associated with the development of chemistry programs in CAI. Although CAI systems have not yet received wide acceptance in chemistry, those anticipating the use of CAI techniques should exercise caution in purchasing commercially prepared CAI programs and should assure themselves that the contents represent modern chemistry standards by requesting to see flow charts of the programs before hand.

Computer-assisted instruction can be adapted to the aptitude of the student in an almost human way. For example, if the student repeatedly makes a wrong selection of possible answers, the computer statements could be made kind and patient at first but after several such responses, more stern comments or suggestions for more

The student has finished a laboratory experiment on colligative properties of solutions; in particular he has performed an experiment on the freezing point of a solution of acetic acid in benzene.

ENTER

Well, now that you have completed the experimental work on colligative properties in the laboratory, perhaps we can discuss your results. In considering the use of colligative properties such as the freezing point depression of a solution to determine the molecular weight of a solute, what factors affect the freezing point of a solution?

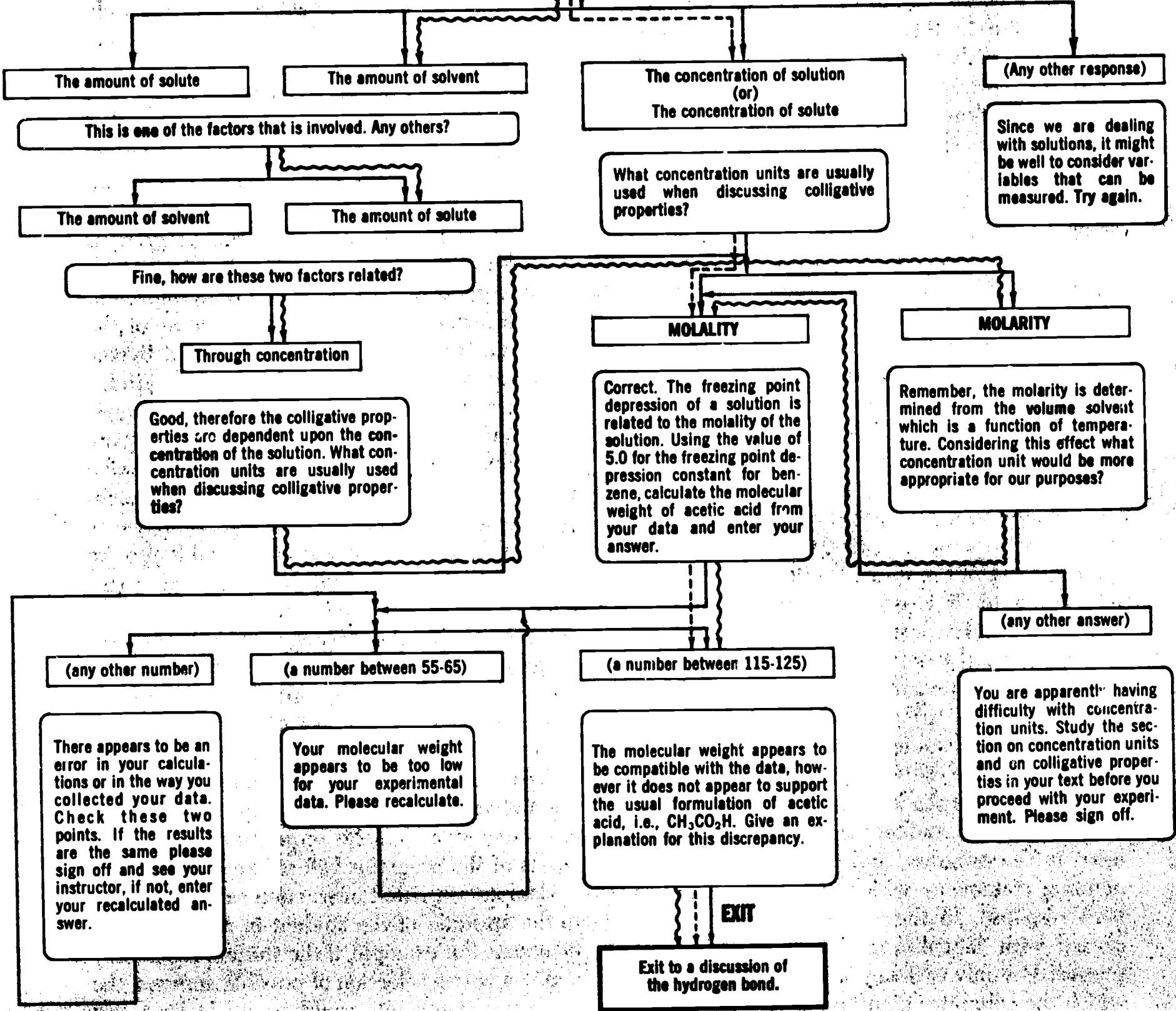
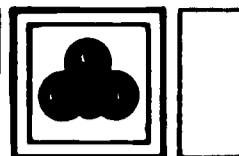

FIGURE CI-4

A portion of a flow chart for a program on colligative properties and hydrogen bonding. Many of the details involving, for example, equivalent student responses and key word responses have been omitted for clarity of presentation. The path that a well-prepared student might follow is indicated by a dashed line (---), while one of the many paths for a less well-prepared student is indicated by a wavy line (~~~~).



intense study of the topic could be programmed into the computer. Conversely, if the student does well, the statements of commendation can vary, at one time calling the student by his last name, but with a compliment attached, and on another occasion with a short complement and the student's first name. There is evidence to suggest that some CAI programs have failed to teach well because the teacher-program authors have used stilted, formal phrases in the statements they prepare for the computer to store and present to the student. A computer can do only what it is told to do! Hence, the statements generated by the computer for the student can, and perhaps should, have a personal quality in many instances. Similarly, trite responses should be avoided as they are not in the normal student-teacher interaction.

THE USE OF CAI IN CHEMISTRY

In some of the literature on the subject, it has been suggested that CAI can, and will soon, replace or minimize the independent utilization of many of the more familiar teaching tools. Other opinions dispute such claims, and support the contention that CAI can eventually become another important and versatile tool — a view supported by this report. The following brief descriptions of different possible uses of CAI (only a few of which have as yet been even tentatively explored) will indicate some of the ways in which this technique might prove useful in chemical education.

Laboratory. In the laboratory portion of a course, students are usually expected to acquire some manipulative technique as well as a facility for handling experimental data. Thus, a technique may be taught in the laboratory (e.g., titration) and then the technique may be belabored endlessly to show the student how it may be used to obtain experimental results directed to a variety of ends. For example, it is not uncommon to have students do acid-base titrations, equivalent weight titrations, oxidation-reduction titrations, etc. However, all these experiments involve a basic titration technique and the student usually spends more than a few afternoons doing essentially the same thing, each time for a slightly different reason. While

some repetition of technique is essential, over-exposure may detract from the learning of data handling and the understanding of principles. To minimize this, CAI methods can be employed to provide (a) supplement laboratory experiments to give him experience in manipulating laboratory data or (b) simulate laboratory experience before the student enters the laboratory. Each of these represent legitimate uses of CAI when properly applied.

For example, the student can be assigned to conduct a trial titration at the computer terminal either before or after he has had laboratory experience. In this instance, the computer may ask the student to decide upon the preparation of a primary standard (or, it can just as readily ask the student to identify the first step of the titration instead of naming it for him). The student then selects a primary standard, and the approximate amount of the substance to be titrated, whereupon the computer gives the student the precise weight of the sample. Next, the student decides to use, say a 100ml volumetric flask, and the computer responds by indicating that the quantity of sample weighed will not dissolve completely in this amount of solvent, whereupon the student will either have to decrease the sample size or increase the size of the flask. After more of this kind of dialogue, eventually the student simulates the preparation of his solution and arrives at the details of the titration. At this time, utilizing pertinent data and a generalized program (which would not necessarily be prepared by a teacher-program author, but would be available to him as a subroutine by calling for it with a code word in a Fortran-like computer language), the computer would calculate the pH of the solution for each increment of titrant added by the student. The data thus provided could be used to plot a titration curve and to calculate the concentration of titrant.

It is possible to write a program that incorporates the experimental error expected for the equipment normally used in this type of experiment. In this case, a second or third computer-generated titration curve using the same sample would give a similar but not identical answer!

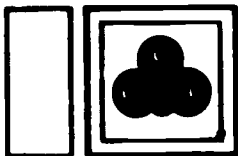

In further dialogue, the student could now elect to use his simulated standardized solution in an appropriate way. For example, a simulated unknown acid could be computer-titrated with the standard solution and the pH of the unknown obtained from the computer for each increment of titrant. The student would then be asked to plot his data and calculate the equivalent weight of the acid. Another sub-routine could simulate a deterioration of a standard solution, if this were chemically realistic and desired by the teacher-program author. The limitations of this type of application is by no means restricted to titrations, but rather reside in the limits of the imagination of those who participate in the preparation of programs for CAI in chemistry.

A different kind of laboratory simulation incorporating visual presentation controlled by the computer is applicable to qualitative analysis (7). In this instance, the student sees on a screen a picture of an unknown solution in a beaker, or perhaps in a test tube. After a dialogue with the computer which terminates in the student's deciding which, and how much, reagent to add, the next picture shows the results of the addition. Then the student might select a separation of a precipitate and a decantate, say by filtration, and after telling this to the computer, the corresponding slide appears and shows the results. Obviously this mode of instruction would require the preparation of the slides in advance. Currently, a maximum of 1000 slides can be stored in a random access projector and their rapid display controlled by the computer.

Tutorial assistance. CAI provides an ideal medium for the presentation of tutorial, drill, or remedial material in subjects where the onus in the teacher-student relationship rapidly shifts from the instructor *teaching* to the student *learning*. Stoichiometry, balancing equations, and formula writing represent a few of the more obvious subjects for initial CAI programs in general chemistry. It is not possible, as has been suggested above, for a teacher-program author to predict all of the possible key words and synonyms that might appear in the responses of a large number of students. Although it is possible

to insert amendments to correct such deficiencies as they occur, it may not always be necessary or desirable to do so. That is, at some points in a dialogue, with the computer, the student may reach an impass, i.e., a point where no statements in the computer are suitable for his response. In such a case, the next computer statement can advise the student to see his teacher personally and even set up an appointment for him). The computer could even advise the teacher that this particular student has understood a topic up to a point, briefly describe the point giving difficulty, and describe the next point to be covered after the difficulty is eliminated. With this type of information, the teacher can, with less time involved, help the student over the hurdle personally, and send him back to the student terminal for further dialogue there.

Evaluation of student ability and progress. While the student is at a terminal, responding to the statements he receives from the computer, a record of individual student responses in summary form can be maintained by the computer for the teacher. Later, when using another program, the computer can readily indicate to the teacher that a student has, or has not, demonstrated an improvement in his proficiency in his studies as measured by a change in responses to perceptive answers to the computer statements.

It has been proved to be possible to generate individualized quizzes on subjects that lend themselves to this technique. Thus, with CAI equipment it is possible to construct a series of examinations on which the student must reach a specified level. These examinations would be available on demand when the student feels he has mastered the material. The computer program can generate the examination, grade it, inform the student of the results, and keep a record of the grade.

Incorporation of other material. It should be clearly understood that few students can tolerate long sessions at a computer terminal, even though the statements presented by the computer may be lively and provocative on occasion. For this and other reasons, it is desirable to require students to seek help periodically from



more familiar sources. Thus, at an appropriate point in the program the computer statement could ask the student to leave the terminal and seek information from his text, a reference in the library, or a brief experimental investigation, querying him about his findings upon his return. Students who are unable to indicate satisfactorily that they obtained the needed information can be given alternate, easier, assignments (and this fact noted in the record) or they can be asked to repeat the assignment. Any option which is elected by the teacher-program author and incorporated into the program can be employed.

The CAI technique can easily require the student to read and study appropriate material before he uses the computer. For example, after a period of study on a given topic, the initial computer interaction could be a short examination. Based on the result of this examination, the computer could then further instruct the student in only those matters for which his answers were unsatisfactory. Completing this, the computer and the student could proceed to a dialogue which develops the topic to the depth desired.

SUMMARY

With the experience available now, it is evident that CAI techniques can be applied to teaching a variety of topics in chemistry often more efficiently than conventional methods. More importantly, the careful application of CAI allows each student to proceed through the subject at his own rate, reworking the material as often as he feels is necessary. CAI may free the instructor to teach topics that are more difficult to handle or those that may have been omitted for lack of time. Although some might be concerned that CAI methods involve the dehumanization of teaching, it can be argued to the contrary that these techniques provide a method for more individualized instruction, a way of capturing the individuality of a teacher and preserving it for *all* students.

It is apparent that CAI can be more useful to those teachers in chemistry who have computers at their disposal if a method could be devised for the efficient exchange of programs. To help catalyze this exchange, it is suggested that persons interested in exchanging ideas on CAI do so through J. J. Lagowski, Department of Chemistry, The University of Texas, Austin, Texas 78712.



REFERENCES AND FOOTNOTES ON COMPUTER ASSISTED INSTRUCTION

1. International Business Machines Corporation, "1500 Operating System, Computer-Assisted Instruction, Coursewriter II, System Summary," White Plains, New York, 1966.
2. For a description of IBM CAI systems see, (a) G. J. Rath, N. S. Anderson, and R. C. Brainerd, "The IBM Research Center Teaching Machine Project," **Automatic Teaching: The State of the Art**, (E. Calander, Ed.) New York, John Wiley and Sons, Inc., 1959; (b) R. P. Kropp, D. L. Hartford, H. W. Stoker, "Quarterly Progress Report," Institute of Human Learning, Florida State University, Tallahassee, Florida, October 1, 1965, December 31, 1965; (c) H. Mitzel and K. H. Wodtke, "The Development and Presentation of Four Different College Courses by Computer Teleprocessing," CAI Laboratory Interim Report, Pennsylvania State University, University Park, Pennsylvania, 1965; (d) V. Bunderson, "The Texas CAI Newsletter No. 1." The University of Texas, Austin, Texas, February 15, 1966; (e) F. M. Tonge, **Computers and Universities**, Irvine CAI System; A Workshop Conference, Newport Beach, California, November 8-12, 1965.
3. For a description of existing CAI systems see, for example, (a) L. M. Stolurow and D. Davis, "Teaching Machines and Computer Based Systems," **Teaching Machines and Programmed Learning, II**. (Robert Glaser, Ed.) Washington, D.C., National Education Association of the United States, 1965; (b) Q. Zinn, "Computer Assistance for Instruction" **Automated Education Letter**, 1, 4 (1965); (c) R. J. Gentile, "First Generation of Computer-Assisted Instructional Systems: An Evaluation Review." Pennsylvania State University Computer Assisted Instruction Laboratory, University Park, Pennsylvania, 1965; (d) D. D. Bushnell, "Computer-Based Teaching Machines," **Journal of Educational Research**, 55, 528 (1962); (e) D. L. Bitzer, P. Braunfield, and W. Lichtenberger, **Plato II: A Multiple-Student, Computer Controlled Automatic Teaching Device**, **Programmer Learning and Computer-Based Instruction**, (J. E. Coulson, Ed.) New York, John Wiley and Sons, Inc. 1962; (f) L. M. Stolurow, "Socrates: System for Organizing Content to Review and Teach Educational Subjects," **Seventeenth Annual Industrial Engineering Institute Proceedings**, University of California, 1965; (g) J. A. Swets, S. H. Millman, W. E. Fletcher, and D. M. Green, "Learning to Identify Nonverbal Sounds: An Application of a Computer as a Teaching Machine," **Journal of the Acoustical Society of America**, 34, 928 (1962).
4. See for example, J. Young, **J. Chem Educ.**, 40, 11 (1963); *ibid*, 400 (1963) and references therein
5. Coursewriter is a language developed for International Business Machines Corporation CAI systems; see (a) A. Maher, "Computer Based Instruction (CBI): Introduction to the IBM Project," IBM Research Report RC1114, White Plains, New York, 1964, and Ref. 1. For other languages see (b) D. L. Bitzer, E. R. Lyman and J. A. Easley, Jr., "The Uses of Plato; A Computer-Controlled Teaching System," Report R-268, University of Illinois Coordinated Science Laboratory, Urbana, Illinois, 1965; (c) J. McCarthy, P. W. Abrahams, D. J. Edwards, T. P. Hart, and M. I. Levin, "LISP 1.5 Programmers Manual," The Computation Center and Research Laboratory of Electronics, Massachusetts Institute of Technology, Cambridge, Massachusetts, February, 1965; (d) J. G. Kemeny and T. E. Kurtz, "Basic," Dartmouth College Computation Center, Hanover, New Hampshire, January 1, 1966; (e) S. Feingold, "A Flexible Language for Programming Computer/Human Interaction," Systems Development Corporation, Santa Monica, California, February 28, 1966; (f) L. M. Stolurow and H. T. Lippert, "Automatically Translating Heuristically Organized Routings: AUTHOR I," Technical Memorandum No. 21, Training Research Laboratory University of Illinois, Urbana, Illinois, February 10, 1966.
6. See, for example, J. A. Swets and W. Feurizig, "Computer Aided Instruction," **Science**, 150, 572 (1965).
7. The first of this type of program was prepared on the group I cations by R. S. Hirsch and B. Moncreiff (56th National Meeting of the American Institute of Chemical Engineers, San Francisco, Calif., May, 1965), followed by a program on the group IV cations (J. J. Lagowski and C. E. Rodreguiz, 152nd Meeting of the American Chemical Society, New York, September, 1966).