

R E P O R T R E S U M E S

ED 010 716

EC 000 005

TEACHING AIDS FOR CHILDREN WITH CEREBRAL PALSY.
BY- SIMCHES, RAPHAEL F. AND OTHERS
NEW YORK STATE EDUCATION DEPARTMENT, ALBANY

PUB DATE 66

EDRS PRICE MF-\$0.18 HC-\$2.60 65P.

DESCRIPTORS- *PERCEPTUAL DEVELOPMENT, *VERBAL DEVELOPMENT,
*INSTRUCTIONAL AIDS, *CEREBRAL PALSY, *CONCEPT FORMATION,
EDUCATIONAL EQUIPMENT, ALBANY

MANY CHILDREN WITH CEREBRAL PALSY HAVE VARIOUS PERCEPTUAL HANDICAPS WHICH RESULT FROM THE NEUROLOGICAL IMPAIRMENT. TEACHING AIDS ARE DESCRIBED BY (1) NAME, (2) MATERIALS NEEDED IN CONSTRUCTION, (3) PICTORIAL REPRESENTATION, (4) EXPLANATION OF USE, AND (5) THE CONTRIBUTOR'S NAME. CATEGORIES OF AIDS INCLUDE (1) SENSORY DEVELOPMENT, (2) VERBAL DEVELOPMENT, (3) NUMBER DEVELOPMENT, AND (4) PHYSICAL EQUIPMENT AND FACILITIES. ADDITIONAL SOURCES ARE LISTED. (GB)

ED010716

TEACHING AIDS

for

CHILDREN with CEREBRAL PALSY

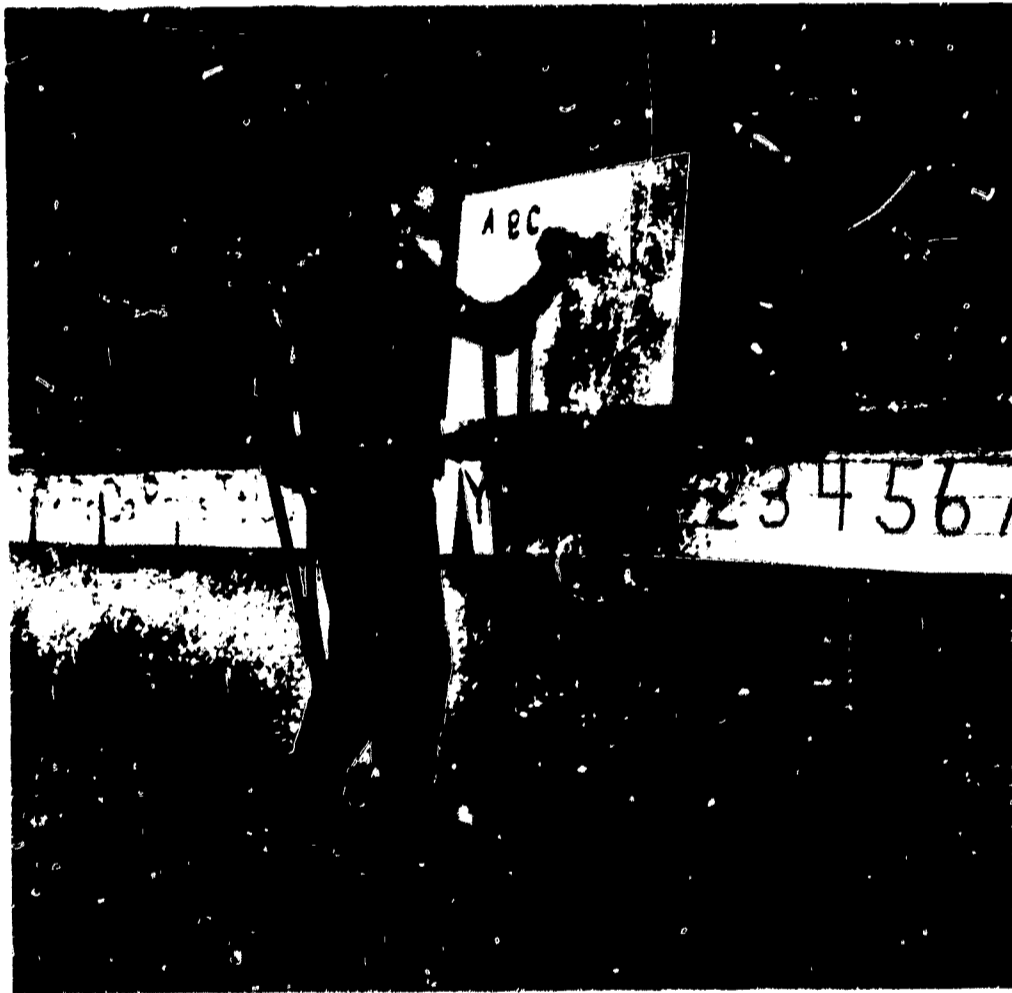

THE UNIVERSITY OF THE STATE OF NEW YORK / THE STATE EDUCATION DEPARTMENT
BUREAU FOR PHYSICALLY HANDICAPPED CHILDREN, ALBANY, 1966

EC 000005

T E A C H I N G A I D S
for children with
C E R E B R A L P A L S Y

U.S. DEPARTMENT OF HEALTH, EDUCATION & WELFARE
OFFICE OF EDUCATION

**THIS DOCUMENT HAS BEEN REPRODUCED EXACTLY AS RECEIVED FROM THE
PERSON OR ORGANIZATION ORIGINATING IT. POINTS OF VIEW OR OPINIONS
STATED DO NOT NECESSARILY REPRESENT OFFICIAL OFFICE OF EDUCATION
POSITION OR POLICY.**

BUREAU FOR PHYSICALLY HANDICAPPED CHILDREN
DIVISION FOR HANDICAPPED CHILDREN,

in conjunction with
TEACHERS OF CHILDREN WITH CEREBRAL PALSY

The University of the State of New York
The State Education Department

Albany

1966

THE UNIVERSITY OF THE STATE OF NEW YORK

Regents of the University (with years when terms expire)

Edgar W. Couper, A.B., LL.D., L.H.D., Chancellor,	Binghamton,	1968
Thad L. Collum, C.E., Vice Chancellor,	Syracuse,	1967
Alexander J. Allan, Jr., LL.D., Litt.D.,	Troy,	1978
Charles W. Millard, Jr., A.B., LL.D.,	Buffalo,	1973
Everett J. Penny, B.C.S., D.C.S.,	White Plains,	1970
Carl H. Pforzheimer, Jr., A.B., M.B.A., D.C.S.,	Purchase,	1972
Edward M. M. Warburg, B.S., L.H.D.,	New York,	1975
Joseph W. McGovern, A.B., LL.B., L.H.D., LL.D.,	New York,	1969
Joseph T. King, A.B., LL.B.,	Queens,	1977
Joseph C. Indelicato, M.D.,	Brooklyn,	1974
Mrs. Helen B. Power, A.B., Litt.D.,	Rochester,	1976
Francis W. McGinley, B.S., LL.B.,	Glens Falls,	1979
George D. Weinstein, LL.B.,	Hempstead,	1981
Max J. Rubin, LL.B., L.H.D.,	New York,	1980
Kenneth B. Clark, A.B., M.S., Ph.D.,	New York,	1971

President of the University and Commissioner of Education
James E. Allen, Jr.

Deputy Commissioner of Education
Ewald B. Nyquist

Associate Commissioner for Elementary, Secondary and Continuing Education
Walter Crewson

Assistant Commissioner for Pupil Personnel Services and Continuing Education
Philip B. Langworthy

Director, Division for Handicapped Children
Anthony J. Felone

Chief, Bureau for Physically Handicapped Children
Raphael F. Simches

FOREWORD

The Bureau for Physically Handicapped Children of the New York State Education Department has for many years stressed the special educational needs of children with cerebral palsy. Local school districts are continually expanding their concepts of special educational services to include more of the multiply handicapped cerebral palsied. The many, varied learning problems of these handicapped children have encouraged special education teachers of such classes to seek information on special teaching aids.

This publication contains materials that have been submitted by teachers who have found them successful in the special education of children with cerebral palsy. It is anticipated that this exchange of experiences will be mutually beneficial to those striving to meet some of the special learning problems of cerebral palsied children.

A spirit of cooperation that exists among teachers of children with cerebral palsy has made this publication possible. Special appreciation is extended to all the teachers who have participated. This publication was prepared under the direction of Raphael F. Simches, Chief, with the assistance of Eugene Plenert and Murray Schubert, Associates, Bureau for Physically Handicapped Children. Special recognition for planning assistance is given to Evelyn Karpel, Special Education Teacher, Cerebral Palsy Class, Schenectady.

PHILIP B. LANGWORTHY
Assistant Commissioner

INTRODUCTION

Success in acquiring skills in school subject matter areas for subsequent intellectual, social and emotional growth and adjustment is dependent upon the development of sensory organs, motor coordination, intellectual level and experiential background. The majority of children with cerebral palsy present multiple handicapping conditions in varying degrees relating to these areas of development. Teaching methods must be adapted to deficiencies involved in any of these factors.

The limitations in mobility and the physical incoordination of most cerebral palsied children prevent development to a level of mental and social maturity consistent with age. They do not possess the normal ability to manipulate objects, explore the house and neighborhood or play with other children. Their background of experiences is more limited and provides less foundation for building new concepts.

A large proportion of children with cerebral palsy have several areas of perceptual handicaps resulting from the neurological impairment. These include visual, auditory and tactile perception difficulties.

Many are lacking in ability for concept formation. They have difficulty in integrating concepts, comprehending relationships and dealing with abstractions of all types.

The neurological impairment often is manifested in behavior dysfunctioning. This may take the forms of hyperactivity, short attention span, high distractibility, disinhibition or perseveration. The emotional status of many cerebral palsied children is affected by the physical limitations imposed. They are often subject to overprotection or rejection and lack of acceptance which may cause severe frustrations.

Due to the multiple handicapping nature of cerebral palsy, many of these children are subject to limited vision, loss of hearing, or speech defects.

Neurological injury or maldevelopment often extends to the intellectual and association areas affecting intelligence. Consequently, a large percentage of children with cerebral palsy function on a mentally retarded level.

A review of all the implications of cerebral palsy makes it increasingly obvious that routine teaching approaches are inadequate for these children. The learning process must be kept as concrete as necessary. Coordinated sensory and kinesthetic approaches must be utilized as much as possible. Extraneous stimuli must be minimized to counter distractibility and short attention spans. Learning materials should be carefully structured to make them as functional as possible.

With such fundamental considerations as a guide, the selected devices and approaches on the following pages were brought together in this booklet.

Teachers are cautioned not to consider these aids as ready-made prescriptions or "cure-alls." What may be useful for one child may not necessarily be practical for another since cerebral palsy is manifested in such a variety of handicapping conditions. Each child's needs must be individually interpreted.

The content of this booklet has been divided into the four general educational categories of I. Sensory Development, II. Verbal Development, III. Number Development, and IV. Physical Equipment and Facilities. It must be recognized that each teaching aid has overlapping elements of more than one category. However, they were placed on the basis of their primary emphasis. In many instances these aids will be applicable to individual educational needs while in other instances they may serve as suggestions for the creation of other adaptations. It is hoped that these suggestions may encourage others to submit additional ideas that can be shared, thereby benefiting the educational process of children with cerebral palsy.

ANTHONY J. PELONE
Director, Division for Handicapped
Children

CONTENTS

Foreword	iii
Introduction	iv
Contents	vi
I. Sensory Development	1
II. Verbal Development	12
III. Number Development	26
IV. Physical Equipment and Facilities	42
Bibliography of Additional Sources	53

SENSORY DEVELOPMENT

Visual, motor, auditory and tactile perceptual difficulties are characteristic in varying degrees of many cerebral palsied children. The teaching aids in the following section have been of value to teachers in their efforts to provide remediation in one or more areas of perception.

Visual Concentration

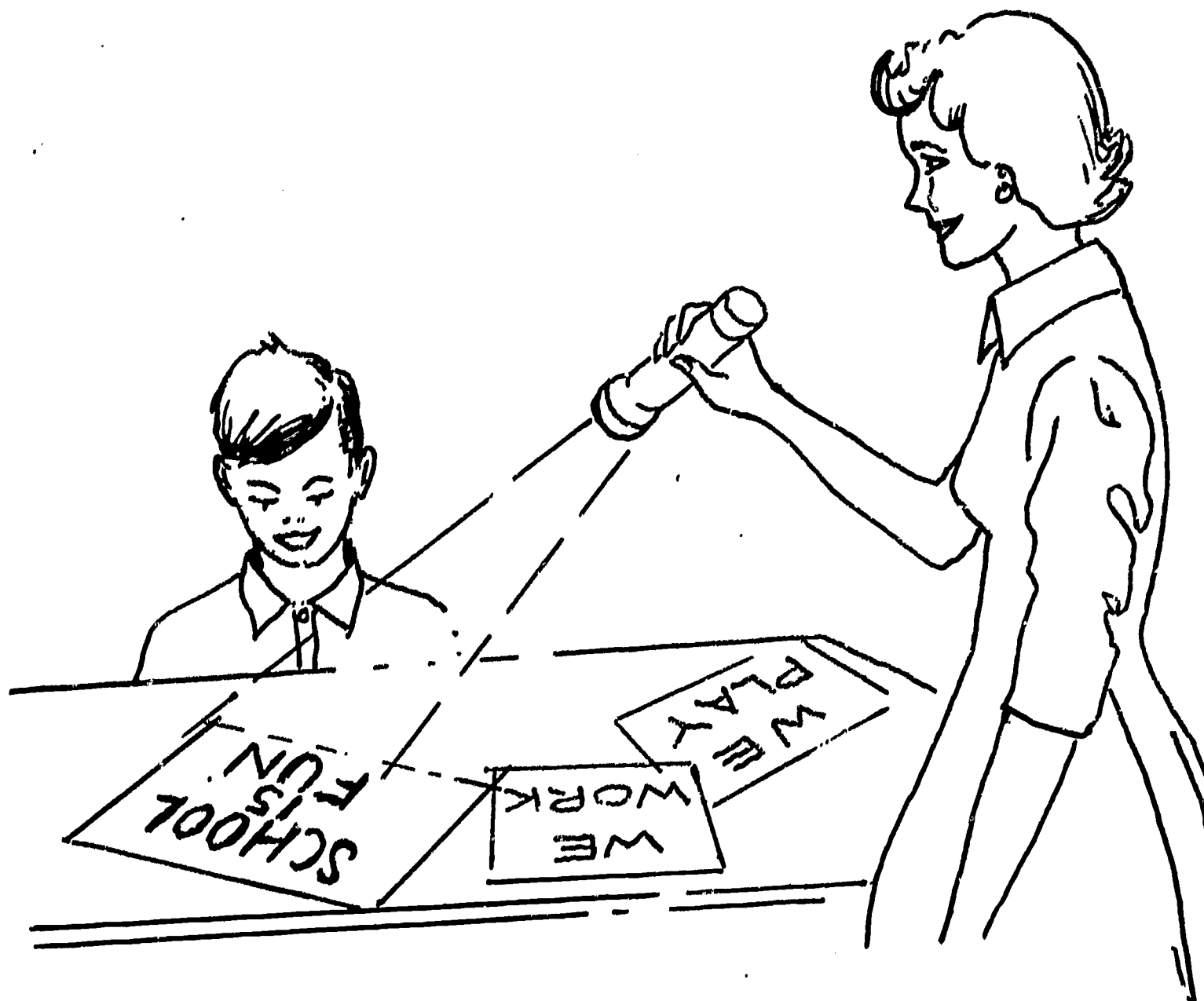

Flashlight, spotlight, or projected materials help to eradicate unwanted visual stimulation and enable child to concentrate on subject projected.

Submitted by:

Sarah Reed
C.P.A. of Western N.Y., Inc.
Buffalo, New York

Visual Memory



Place several objects on a table. Let children look at them. Have children close their eyes while teacher removes one object. See if they can tell which one is missing.

Submitted by:

Mrs. Mary Plumb
Yates School
Schenectady, New York

Tactile Guessing Game



Put ten objects such as a grater, sponge, pan scraper, eraser, etc. in a paper bag. Children handle items one at a time, eyes closed, and guess identity of objects. This game aids in development of tactile perception.

Submitted by:

Mary Plumb
Schenectady, New York

Sponge Blackboard Writing

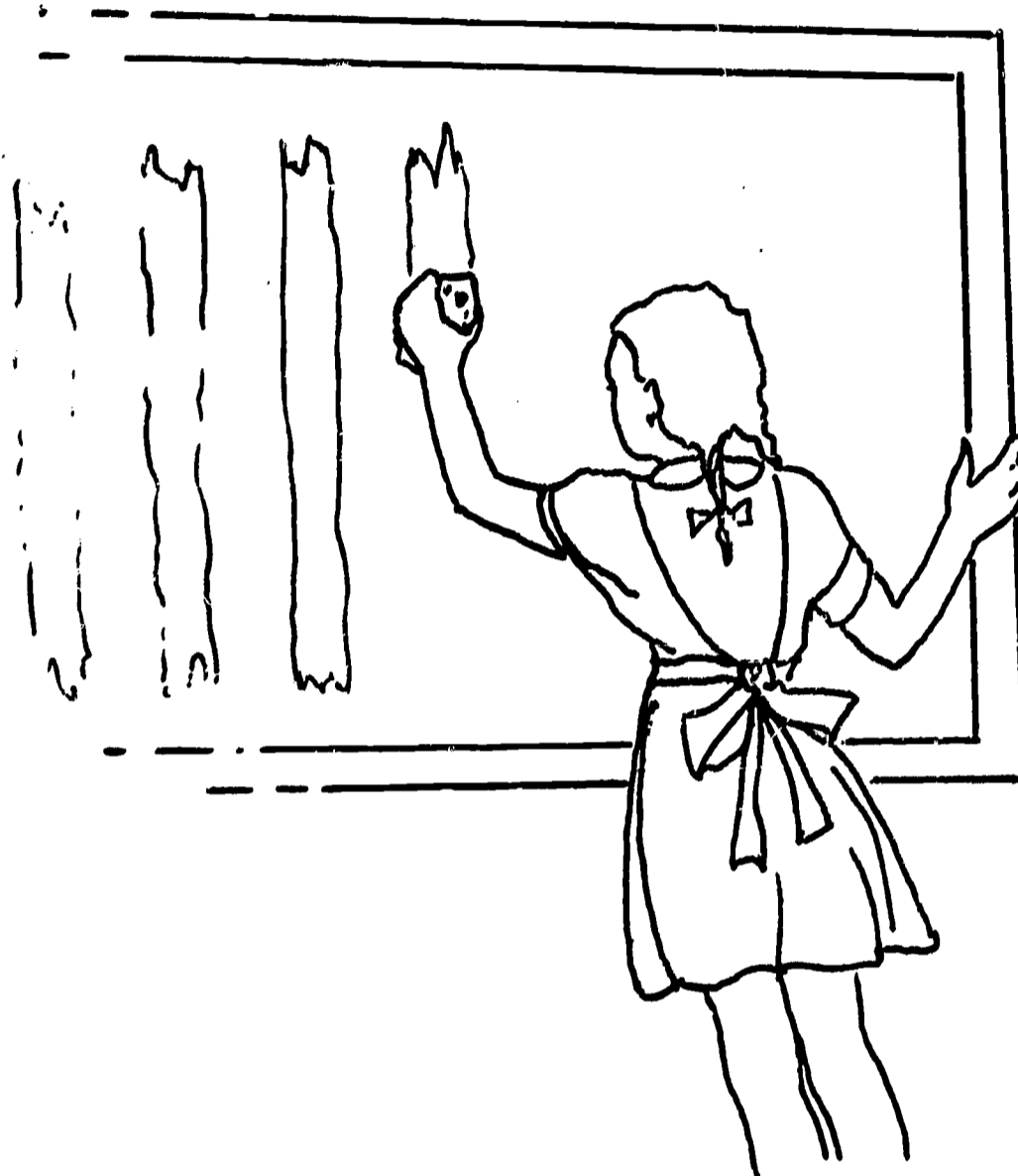

The child practices long strokes with a wet sponge. This helps to improve muscular coordination. This method has been especially helpful with left-handed cerebral palsy children.

Submitted by:

Mrs. Eva D'Agostino
New York City Board of Education
New York, New York

Geometric Stencils

AREAS TO BE COLORED BY CHILD

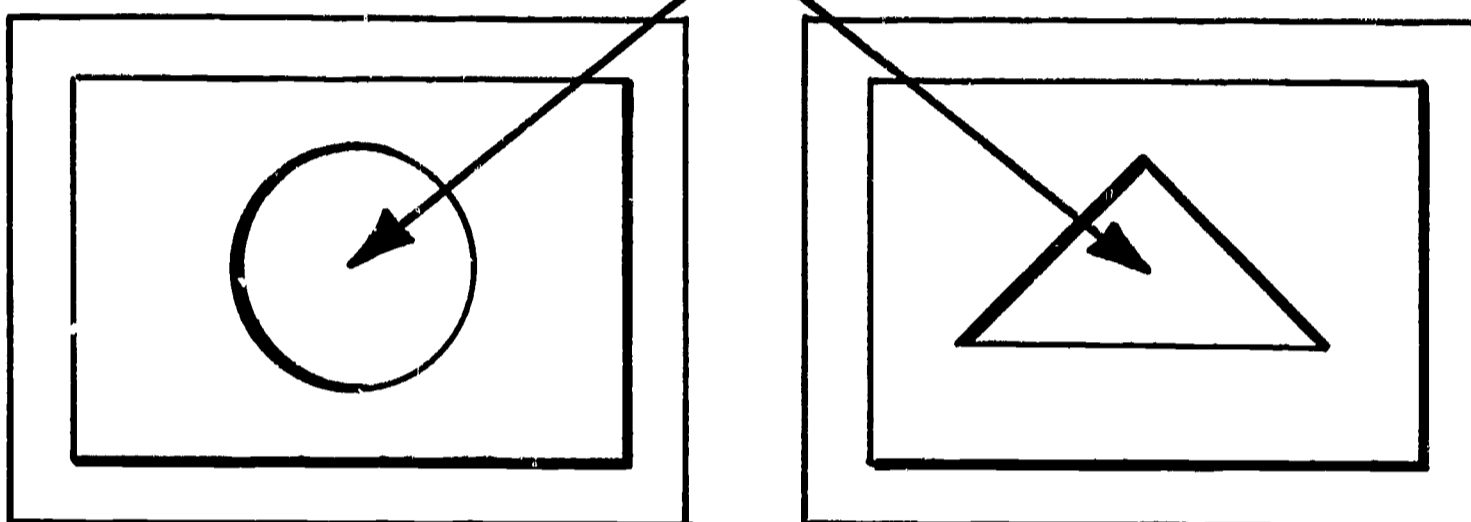

Basic shapes, circle, triangle, square, are cut out of heavy cardboard. The cardboard stencil is then taped over a piece of paper. The child uses a crayon to color in the shape. As the crayon goes around the geometric form, the child feels the outline of the shape. The stencil also helps to confine the child's attention to one area. Device gives child a feeling of depth perception as well as perception of shapes.

Submitted by
Laura Gagliardi
Special Orthopedic Unit
P.S. 85, Bronx, New York

Memory of Visual Sequence

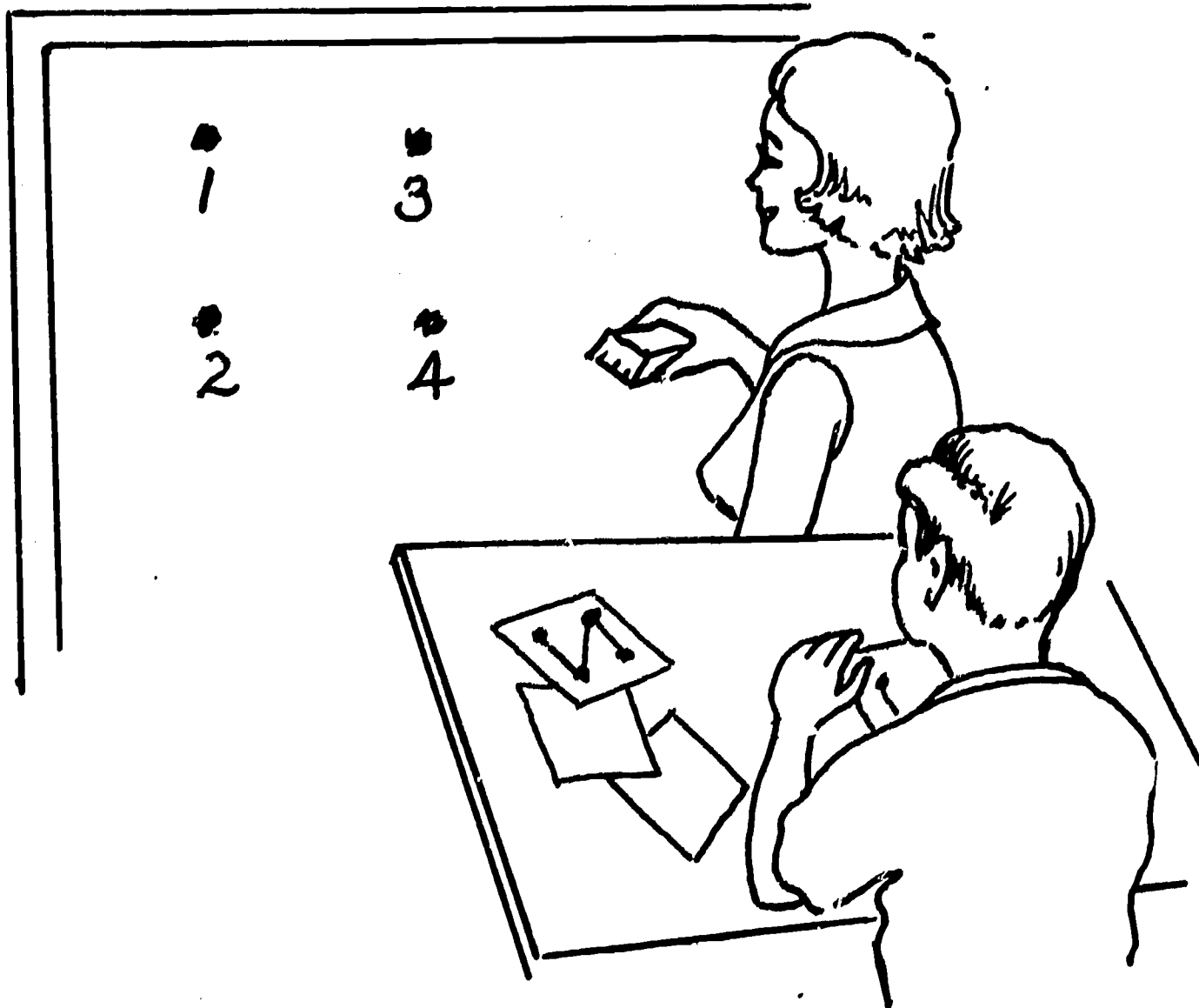

Teacher writes consecutive numbers with a dot above each number on chalkboard. Children study pattern and then the teacher erases numbers. Children try to remember pattern of numbers and connect dots on paper in accordance with the numbered sequence.

These number and dot patterns can be placed on 3" x 5" cards enabling pupils to do individual work at desks.

This test of perceptual ability develops visual sequence memory useful in problem solving and reading.

Submitted by:

Evelyn Karpel
Schenectady, New York

Nest of Cans

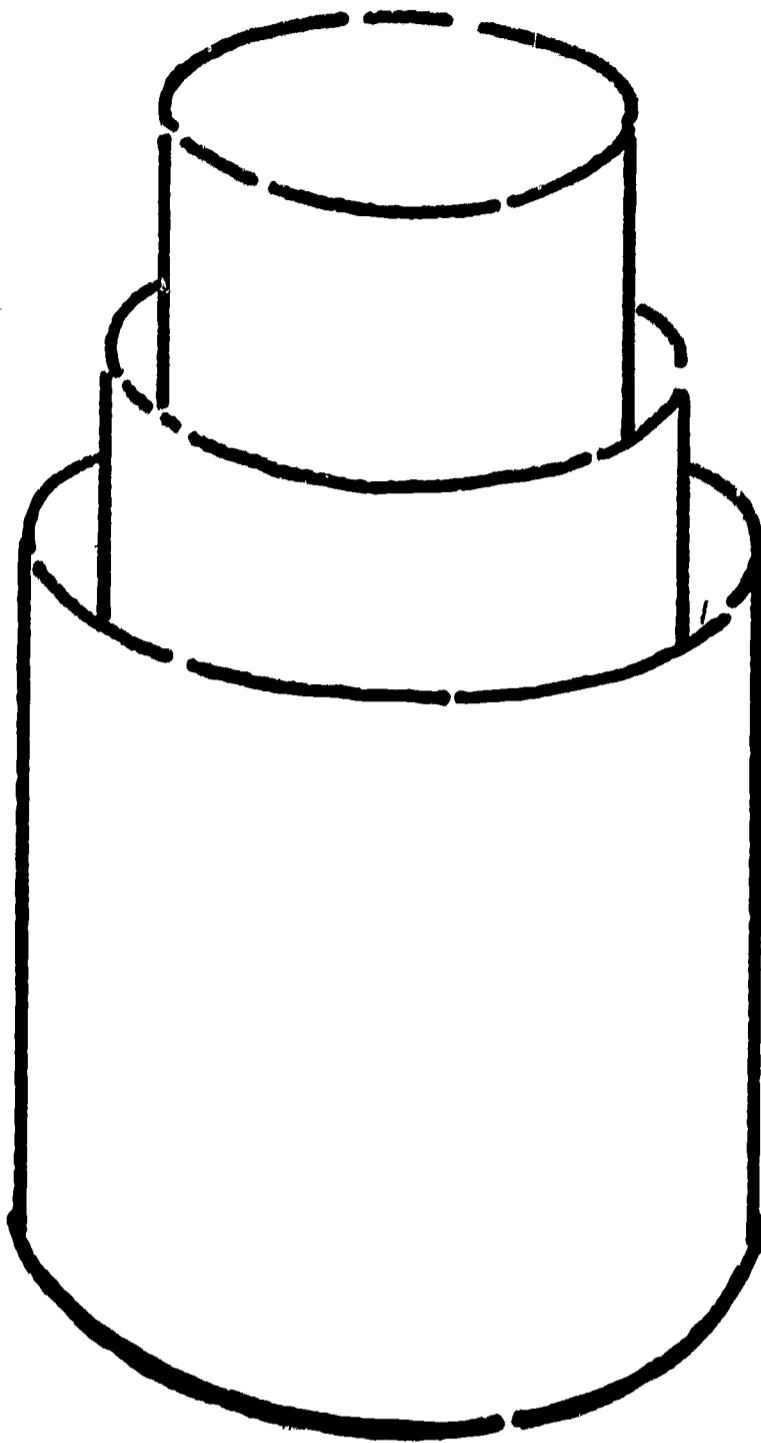

Nest of cans - A graduated set of vegetable cans, from size 2½" up, is also excellent for size and form perception. Remove tops with can opener for a smooth edge, clean, and paint cans in various colors.

Older children can learn size number of cans as a prevocational activity.

Submitted by:

Alpha Chi Omega
Kansas City
Missouri

Concept Aids

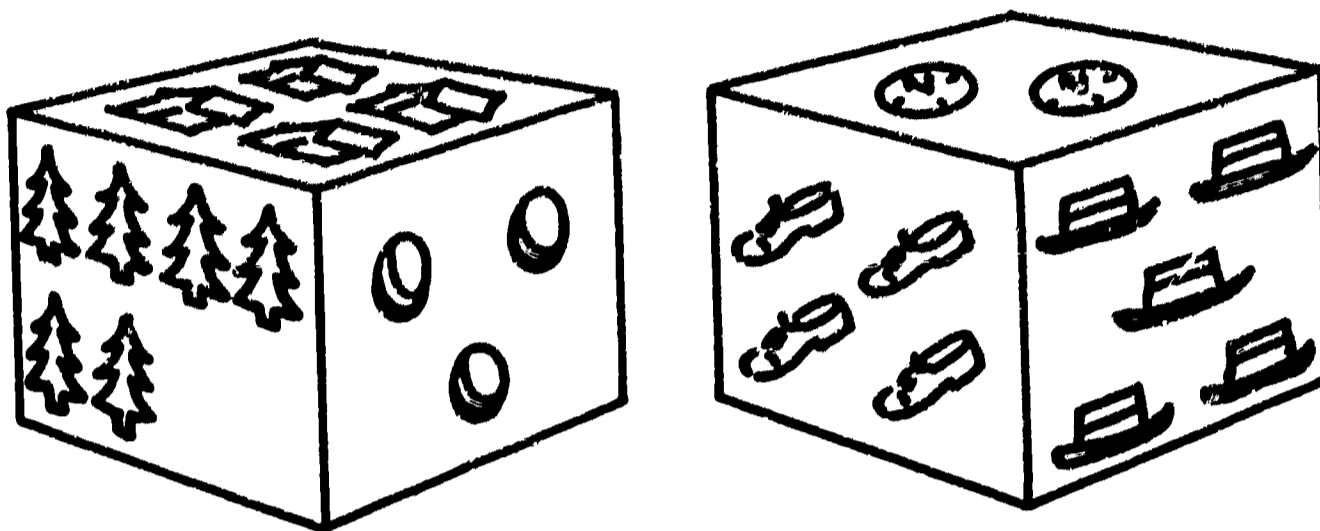

Pictures of houses, balls, butterflies, etc. are glued to several wooden blocks, two inches square or larger, and covered with shellac.

The blocks may be used to follow directions either orally or on work sheet---as "Find the block that has 4 trees."

Arrange like blocks and one different in a row and find the block that is different, or devise other games.

Children with severe handicap can point or indicate answer.

This game develops visual acuity, discrimination in finding like and unlike. It is excellent for reading readiness.

Submitted by:

Evelyn Karpel
Pleasant Valley School
Schenectady, New York

Lotto Type Game

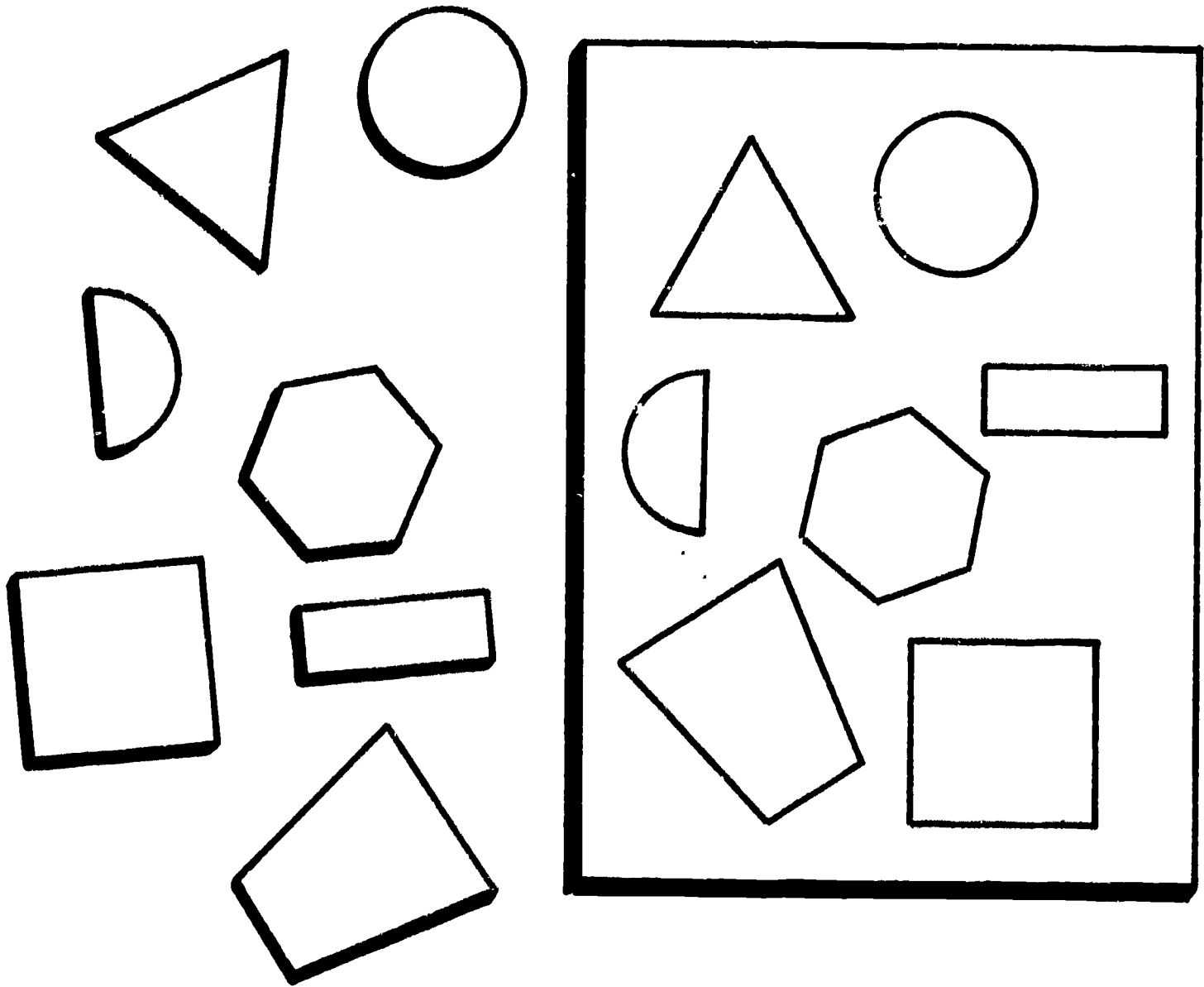

Cut out geometric shapes (two of each) using colored paper or color each shape with crayon. Glue one set on a 9" x 12" cardboard. Shellac, lacquer, or cover the board with clear plastic. Glue the other set of shapes on individual squares. The child pairs separate shapes with the shapes on the 9" x 12" cardboards, matching colors as well as shapes. The separate shapes could be raised about $\frac{1}{2}$ " and mounting would be unnecessary.

Submitted by:

Evelyn Karpel
Schenectady, New York

**Peg Boards
for Problems in Visual-
Motor Perception**

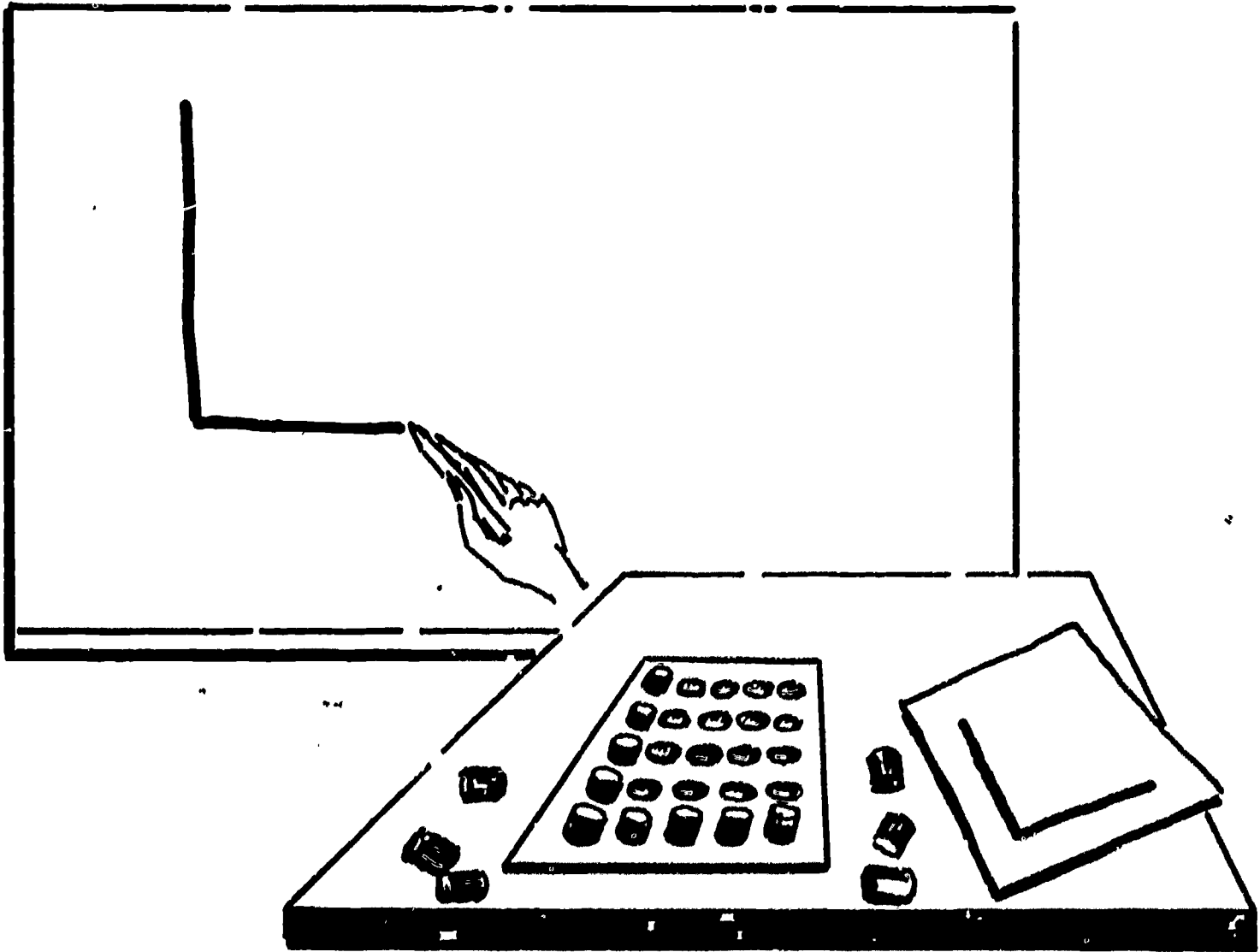

The teacher draws a design. The child is given a 6" peg board and wooden or plastic pegs with which to copy the design. The teacher gives the pattern to the child (near the peg board) and has him copy it. Then the teacher gives the child a blank paper and crayon to draw the same design.

Submitted by:

Mary Wischnacht
P.S. 84
Buffalo, New York

VERBAL DEVELOPMENT

Development of the socially essential skill of verbal communication by reading, writing, spelling, speaking and listening is a difficult and continuing challenge for most cerebral palsied children. The items submitted by teachers for this important developmental task are illustrated in this section and should prove beneficial in teaching verbal skills.

Matching Consonants

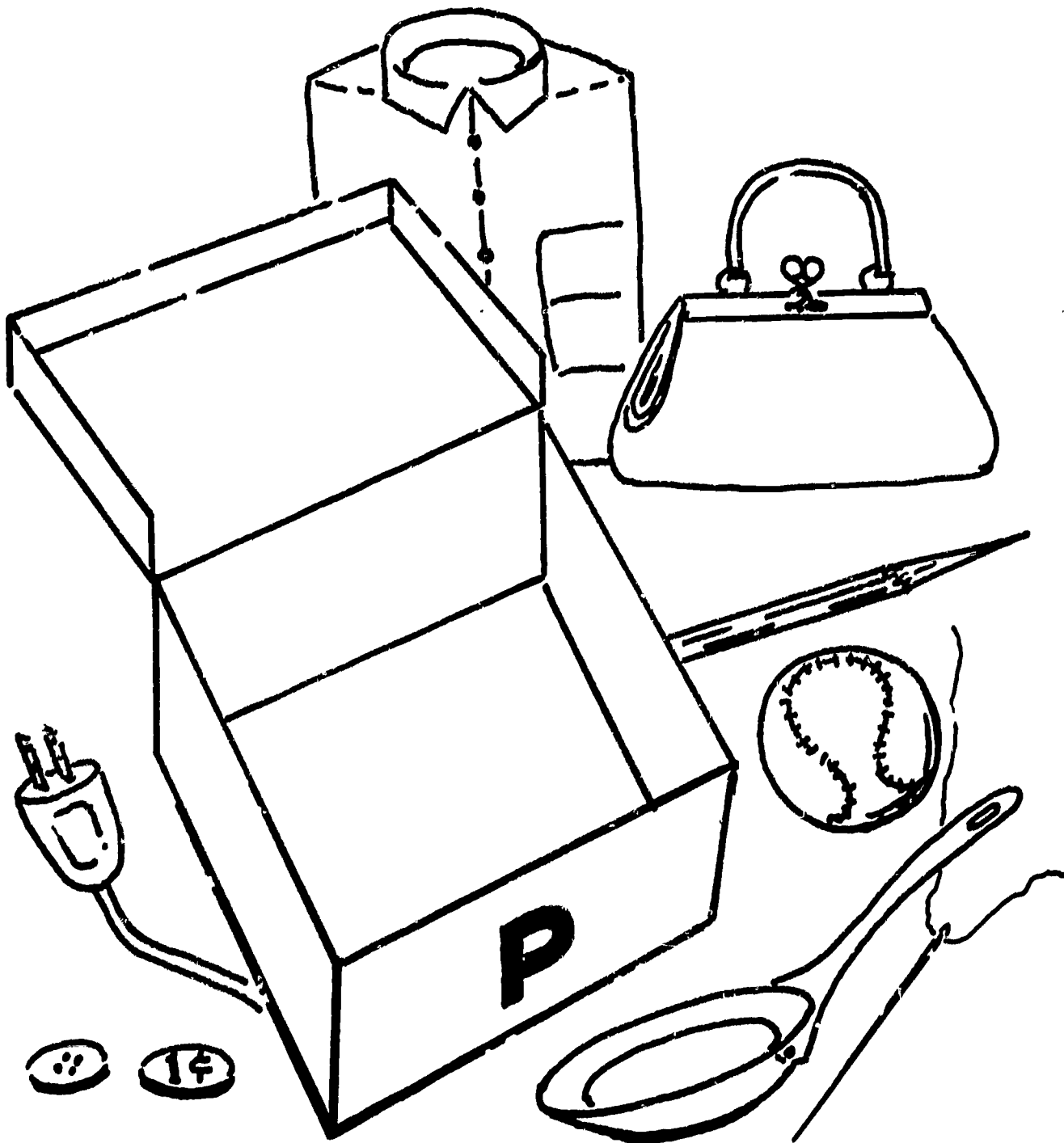

A large painted tin box with a cover is marked by taping on a lettered card. A variety of small plastic objects, toys, and common household articles are collected. The children place all the items starting with the same initial consonant in the box. The teacher and children also repeat initial consonants and names of items as they place the items in the box.

Submitted by:

Mrs. Mildred Hathaway
Yates School
Schenectady, New York

Phonics Boxes

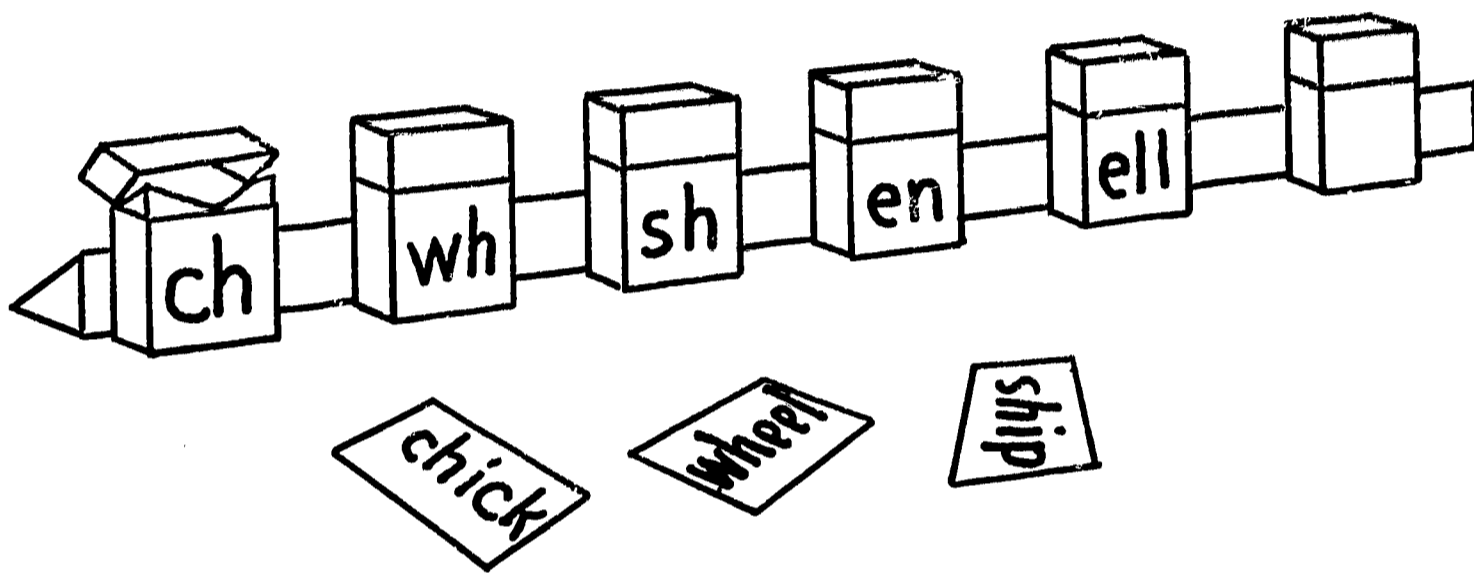

This device has been developed for independent work in phonics. Cardboard cigarette boxes are covered with plain contact paper. They are labeled with letter combinations. They are then attached to a triangular form (corner of cardboard card or wooden stick).

Word cards are placed in appropriate boxes by children.

Submitted by:

Dewey Johnson
Jr. H.S. 133
Bronx, New York

Enlarged Storybook



Cumulative storybook made from enlarged pictures used in beginning reading and for cerebral palsy children with visual perception problems.

Submitted by:

Anne Remis
Rochester Board of Education
Rochester, New York

Word Bingo

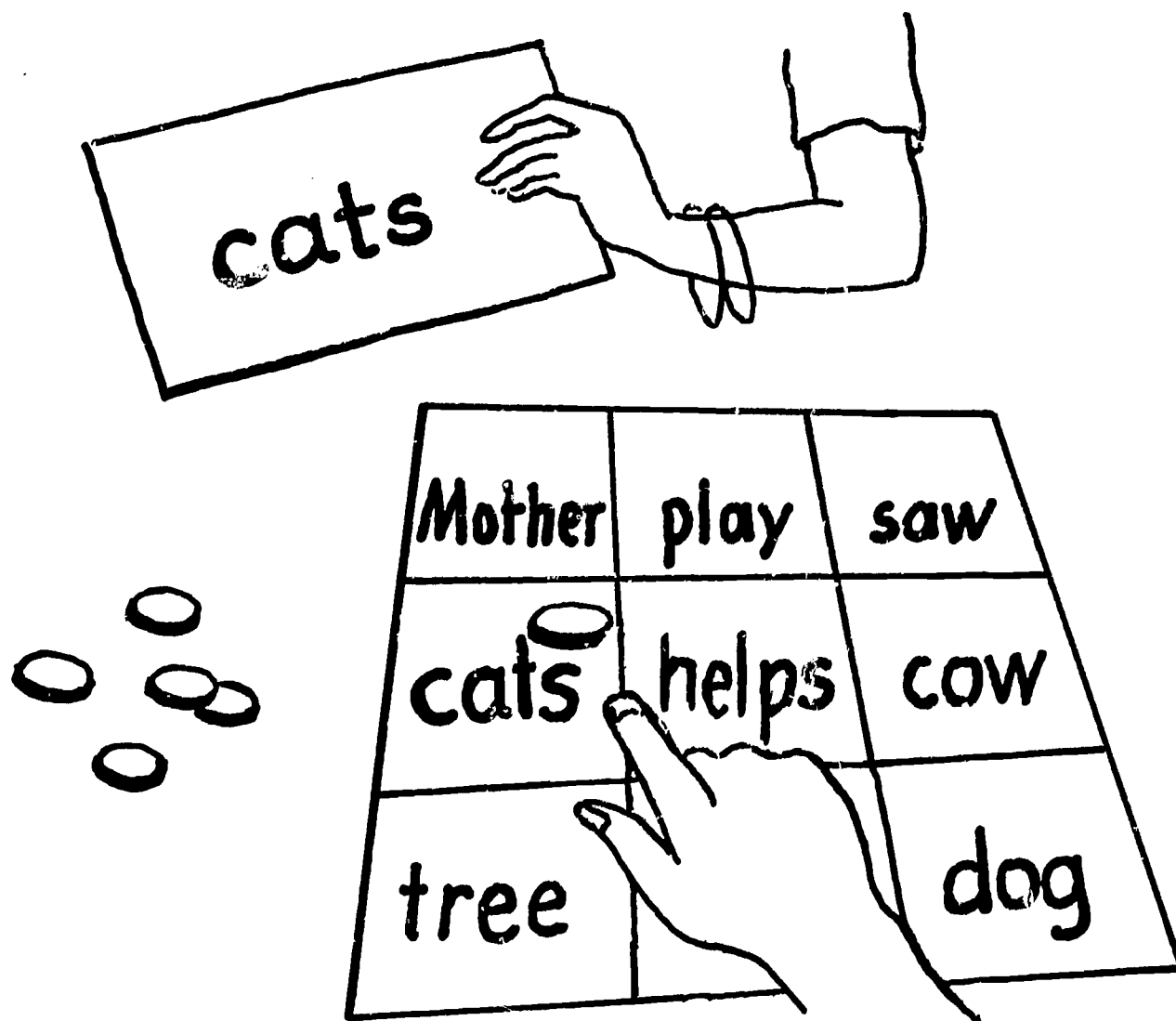

An excellent game for word study. Words are printed on oak tag, 9 on a card for younger children, 15 on a card for older children.

Flash cards are made for these same words. These flash cards are shuffled, cut and turned over in order. The game is played like any real bingo game. The flash cards are turned over one at a time, and if the word appears on the bingo card, the child must cover the word with a wooden disc. The winner is the child who first covers a straight line of words, makes an X, covers the card, etc.

With young children just learning the words, the flash cards can be held up so that they may be seen for comparison, as indicated in the picture. If the words are fairly well learned, the leader who is holding the flash card, reads it, not permitting the child to see the printed side of the card.

Submitted by:

Adele D. Montean
P.S. No. 135
New York, New York

Nursery Rhymes

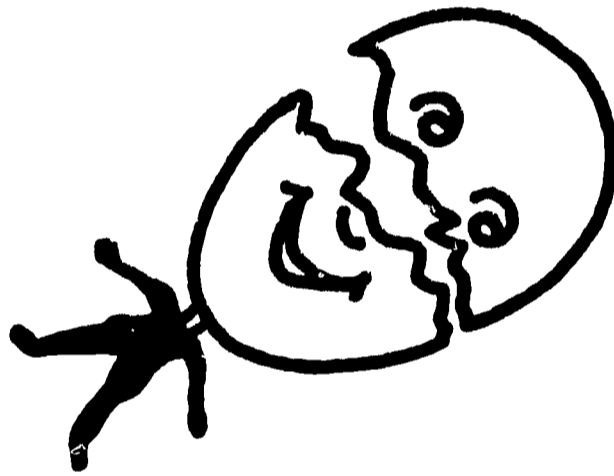
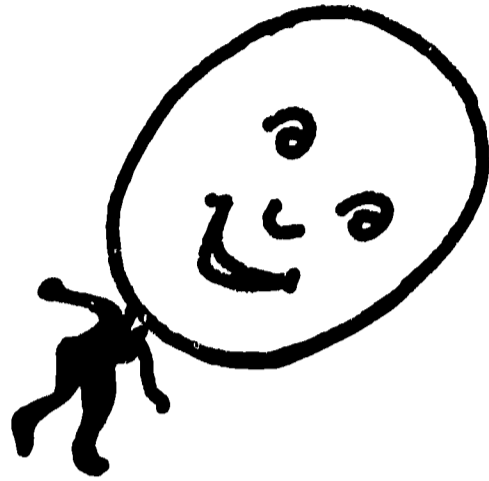
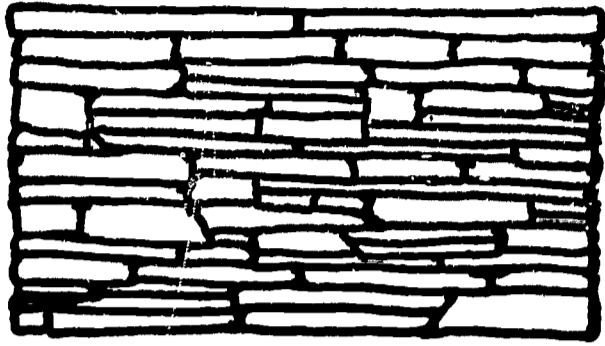

Three dimensional, miniature objects are made for various nursery rhymes. Wood, cloth, or clay may also be used. The child picks up or indicates figures as he says the rhyme. This device develops speech, memorization, hand coordination and attention span. It reduces distractibility by keeping the child's attention focused on the object. It may also be used in music or dramatization.

Submitted by:

Naomi Hooker Chamberlain

Speech Teacher

Formerly of Pleasant Valley School

Schenectady, New York

Reading Comprehension Chart

CINDERELLA	
HER SISTERS WERE NICE	<input type="checkbox"/> N
SHE WENT TO THE BALL	<input type="checkbox"/> Y <input type="checkbox"/> 1
SHE MET THE PRINCE	<input type="checkbox"/> Y <input type="checkbox"/> 2
SHE LOST HER SLIPPER	<input type="checkbox"/> Y <input type="checkbox"/> 3
SHE FOUND HER SLIPPER	<input type="checkbox"/> N

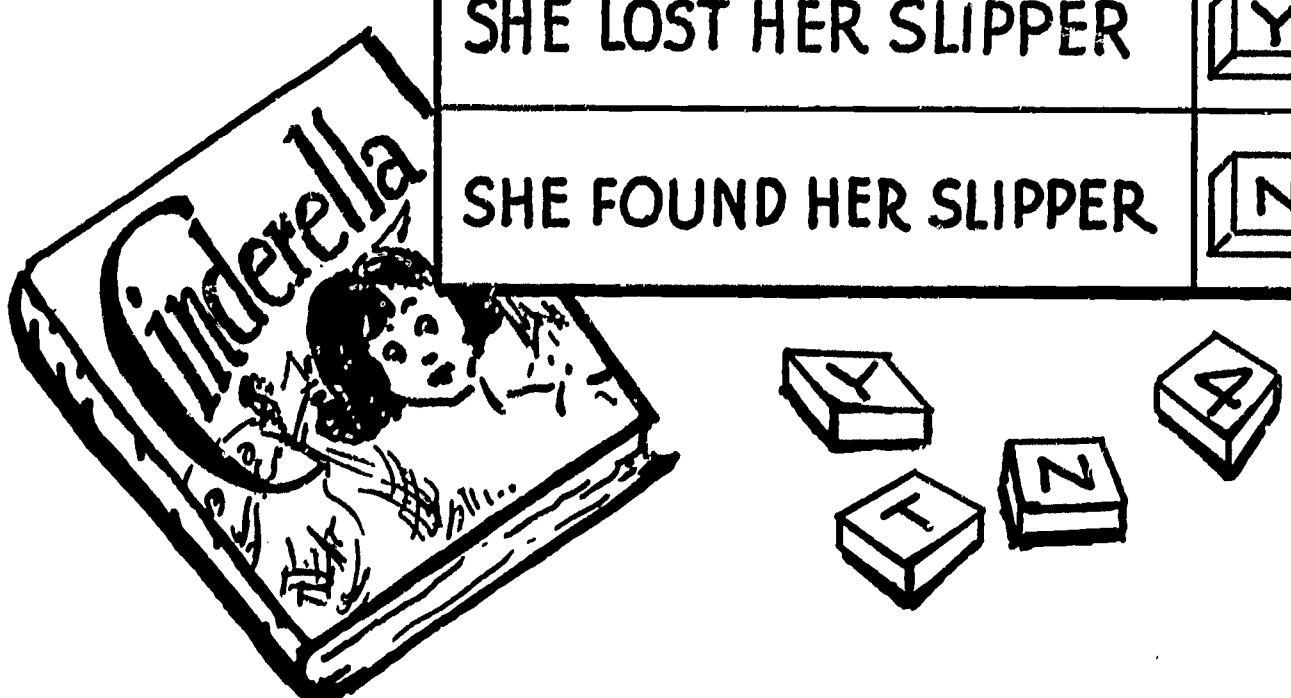

Questions or statements about material that child has read are written by the teacher on large paper. The child has cubes, 1½" blocks, with "Y" or "N" signifying yes or no. The child places a cube at the end of the sentence indicating an affirmative or negative answer.

Number cubes may also be used to signify sequence of events.

Submitted by:

Mary Swart
P.S. 84
Buffalo, New York

Keyboard Chart

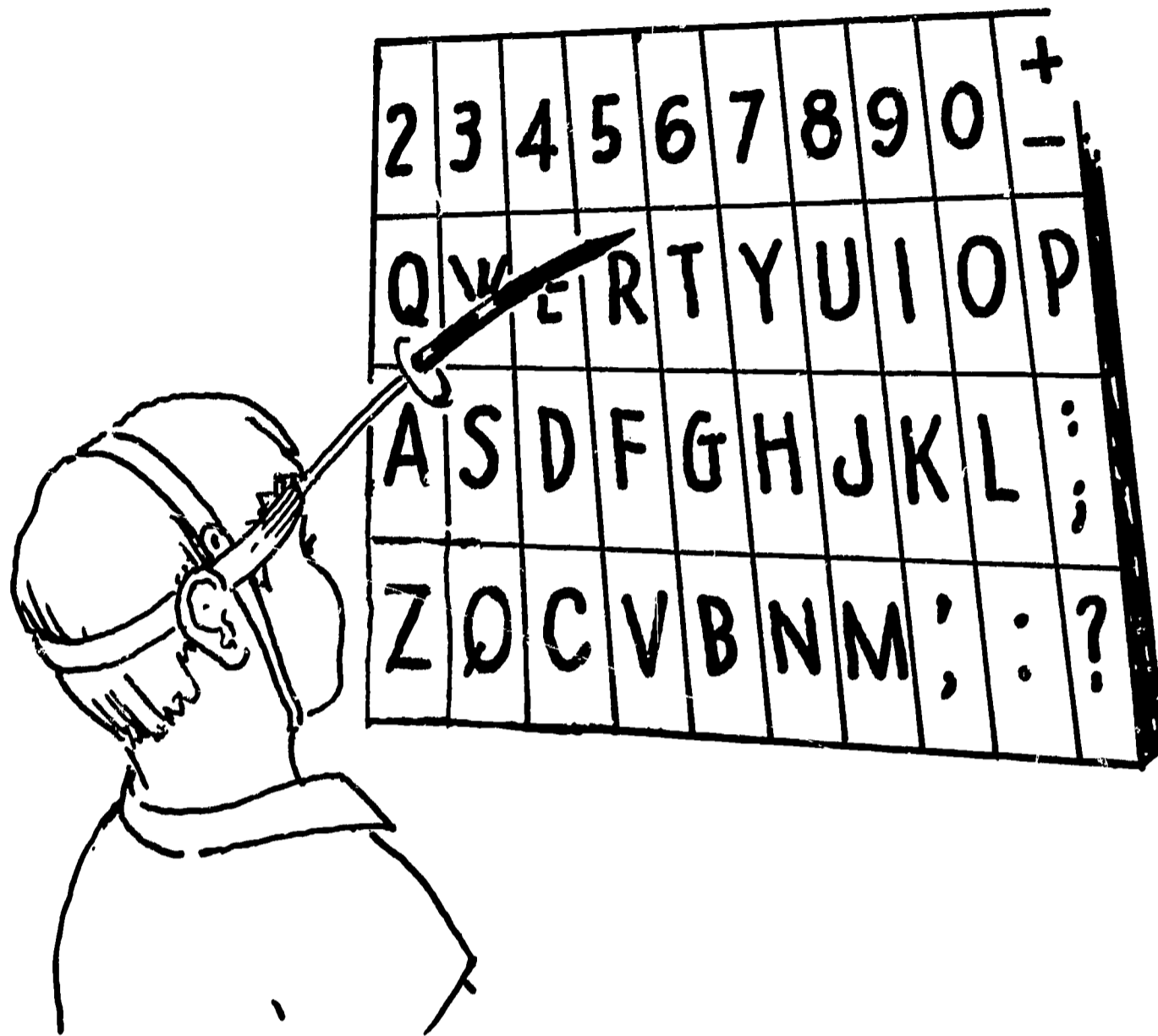

This chart is recommended for a child with little communication and poor coordination. Transpose the letters of the typewriter keyboard on heavy cardboard or on a checker board. Child points to the letters of the word he wishes to express with helmet and attached pointer. This chart aids in communication, spelling, and learning of keyboard for typing.

Submitted by:

Ruth A. Mass
Special Orthopedic Unit
P.S. 85, Bronx, New York

Word Cards

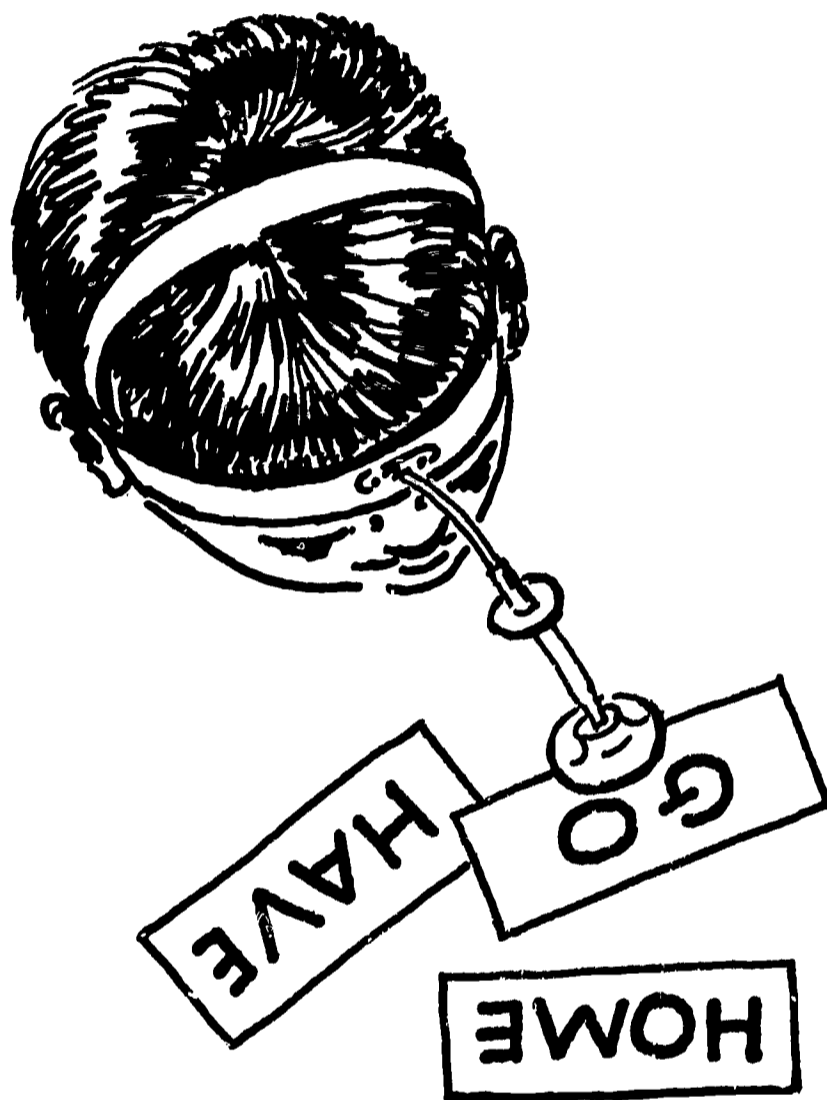

Child moves the word cards with pointer of the helmet alphabetizing and placing words in sentence form.

This technique enables child to communicate when he has no speech or writing ability.

Submitted by:

Ruth A. Mass
Special Orthopedic Unit
P.S. 85, Bronx, New York

Individual Language Board



Each language board content is designed for a particular child. The child learns to express his wants by pointing to a picture. As he advances, the language board will contain more pictures and then will gradually be replaced with words as his control, reading and comprehension increase. The language board is only used extensively when all other methods of teaching speech as a method of communication have failed.

The language board is constructed by placing a plastic sheet over the wood board. Oak tag is cut to size and inserted between the wood board and plastic top. The oak tag may be replaced with different pictures and words.

Submitted by:

Reginald Feltham
Director of Special Education
Suffolk County
Second Supervisory District

Conversation Board

here	it		go	make	want	
	we		help	play	work	
where	you	can	is	run		
	my	come	jump	said	maybe	
why	me	find	look		yes	
green	red	orange	yellow	blue	purple	black
1	2	3	4	5	6	
7	8	9	0	Thank	you	please
My name is Gerald Jones. the this that						

The conversation board consists of a series of charts constructed of heavy paper. Letters, basic words and illustrations (at the child's own developmental level) are placed on these charts. The charts are covered with clear plastic and mounted securely on a desk or plywood board. The conversation board offers a means of expression for those whose ability to do so in other ways is limited. The student uses his fingers or clenches a small dowel stick to point to the letters, words or numbers on the chart he wishes to use. If he has no hand use, he directs his eyes to the words.

A guide for the development and use of a conversation board is available in the publication, Aphonic Communication for those with Cerebral Palsy, published by the United Cerebral Palsy Association of New York State, 220 West 42 Street, New York, New York 10036. (Information on new findings developed since publication of the booklet may be obtained from Miss Anne I. Remis, Special Class Teacher, City School District, Rochester, New York)

Submitted by:

Anne I. Remis
Rochester, New York

Word Color Recognition

blue	○
yellow	○
red	○
brown	○
green	○
black	○
purple	○
orange	○

OAK TAG
18"

A.

red	orange	black
green	blue	yellow
brown	purple	red

12"

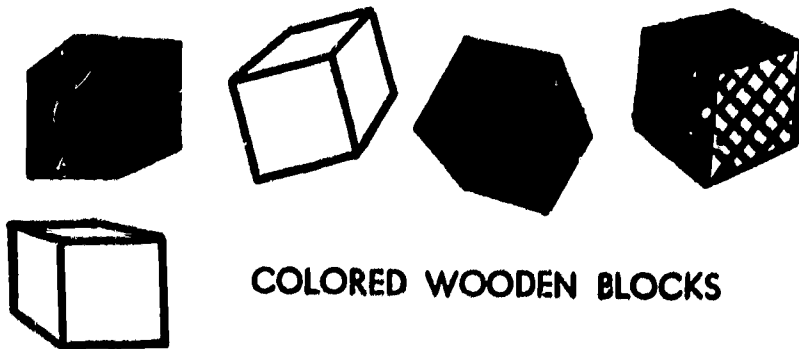

COLORED WOODEN BLOCKS

This device may be used as an aid in determining reading readiness of children with little or no speech.

The purpose of the activity is to check word matching ability and to teach color words. The child puts a block on the correct color words (A). The device provides a manipulative activity to hold a distractible child's interest. It indicates a child's ability to match words. It is a self-tutoring device for teaching color words. It provides work most cerebral palsy children can do independently, thus freeing the teacher to help others. This device may be used as an aid in determining reading readiness of children with little or no speech. The lettering should be at least one inch in size if used with primary children.

Submitted by:

Louise Sullivan
Syracuse Board of Education
Cerebral Palsy School

Kinesthetic Learning



A kinesthetic approach is provided by tracing letters and words over teacher's copy with finger, chalk, crayon, or pencil.

Submitted by:

Evelyn Karpel
Special Class Teacher
Jayne B. Rycheck
Supervisor of
Special Education
Schenectady, New York

Pegboard

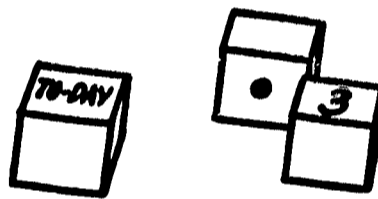
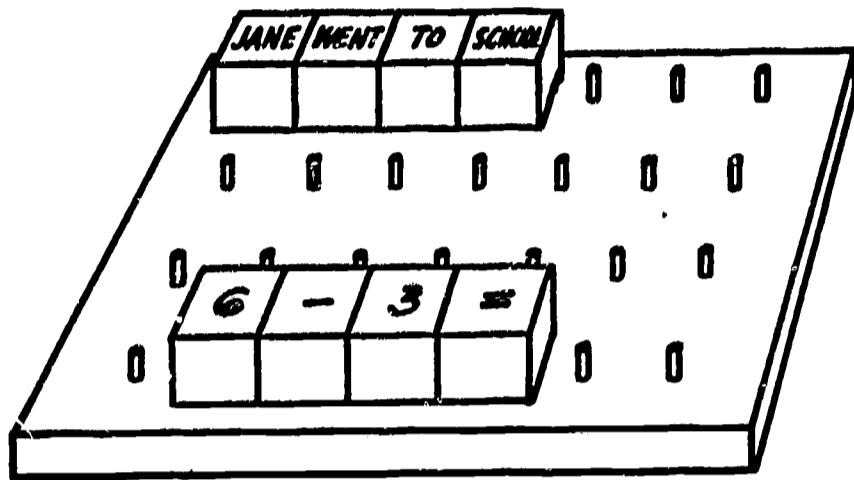

Holes are bored in bottom of blocks, one inch square or larger, to fit 10 to 15 wooden pegs on 12" x 12" x 1½" wooden board. Space pegs 2" apart to enable child to grasp block easily. Paint blocks bright colors and paint board neutral colors. Scotch tape words, letters or numbers on blocks. Child can arrange numbers, spell words, make sentences etc. The device is excellent to follow through with occupational therapist in grasp and release exercises.

Submitted by:

Evelyn Karpel
Pleasant Valley School
Schenectady, New York

NUMBER DEVELOPMENT

The quantitative concepts required for the cerebral palsied child's adjustment to the demands of society, particularly in the vocational area, have encouraged teachers to develop many concrete and manipulative aids for learning number skills. The teaching aids in the following pages have been suggested by teachers for this purpose.

Poker Chips

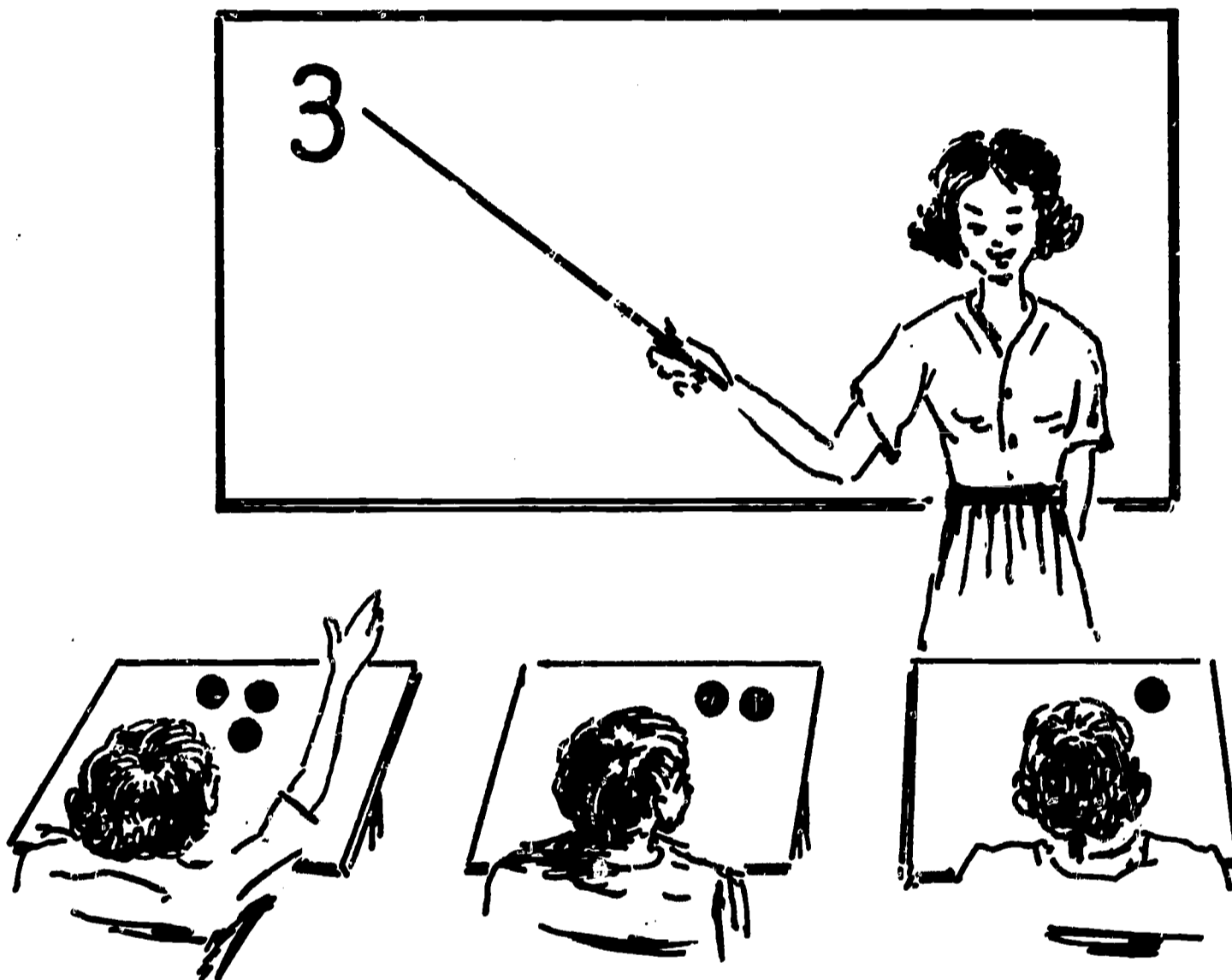

A different number of poker chips are distributed to each child. The teacher asks a child having a certain number of chips, e.g. 3, to raise his hand. The teacher writes number on chalkboard and the child with the corresponding number of chips calls out the number or raises his hand. Teacher writes number, 1 through 10 on the chalkboard. A child circles a number and other children place that number of chips in a group.

Submitted by:

Evelyn Karpel
Schenectady, New York

Screw Board

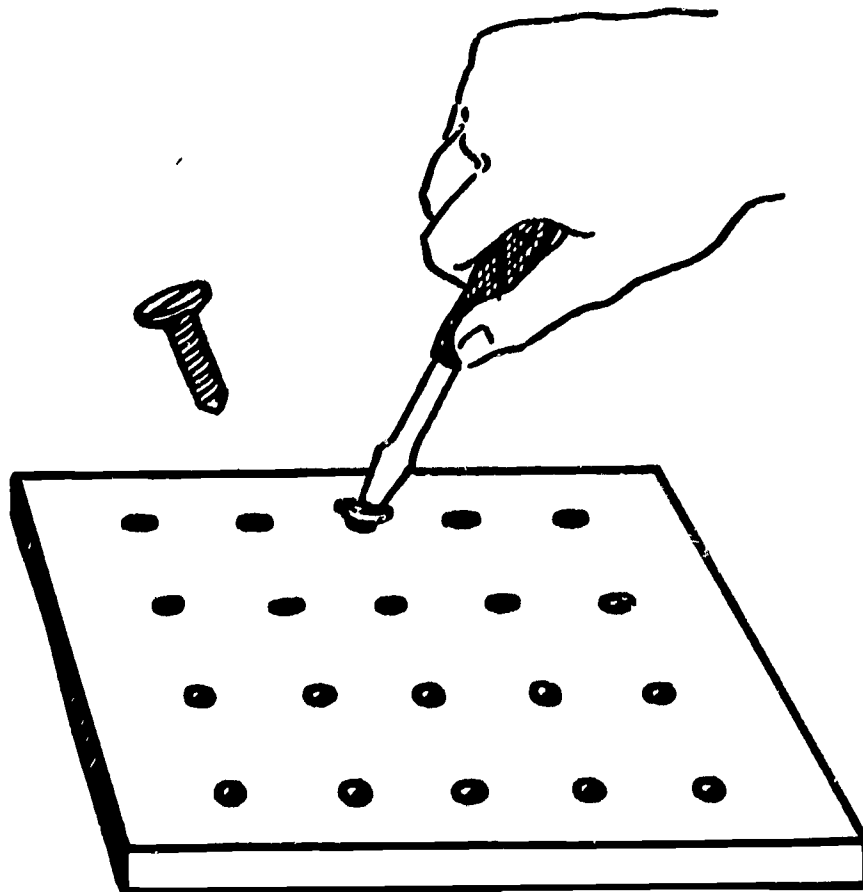

Ten holes are bored 2" apart in a painted board 12" x 16" x 1 3/4". Wood screws are obtained to fit the bored holes. The screws must have large heads for ease in handling. The screwdriver must have a large firm handle. Paint a different color around each hole. It is used mainly in counting as a device to slow disinhibition tendency. It helps to focus the attention of a distractible child by use of a manual device.

Submitted by:

Evelyn Karpel
Pleasant Valley School
Schenectady, New York

Number Concept Aid

A

4	7	3
1	5	8
6	2	9



PEGS

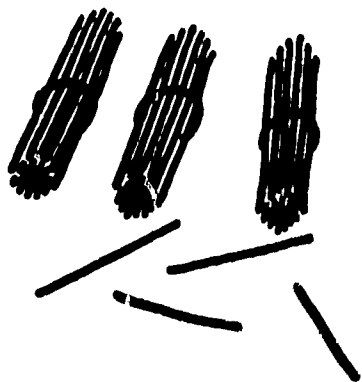

SMALL COLORED STICKS
BUNDLES OF TEN AND SINGLES

10	16	13
18	12	15
11	19	20

The purpose of this aid is to check child's cardinal concept of numbers (1-10), (10-20), (20-100). It does not require as fine hand coordination as drawing circles or squares etc. to indicate 1-10. It is possible to check concept of value of larger numbers. This provides a concrete method (very important to C.P. child) of teaching the value of numbers. The child puts the correct number of sticks on each section of the card after the child has observed the teacher putting some of the colored sticks into bundles of 10. A variation may utilize pegs in the squares as (A) above. This device occupies the child motorically. Counting sticks helps to slow down the disinhibited child. It is used also to achieve integration of visual, verbal and motor functions. Through concrete means, it not only checks child's cardinal concept of the numbers to 100 but promotes greater insight into the structure of our number system. It is an activity which children can do independently, thus freeing the teacher to work with other individuals.

Submitted by:

Louise Sullivan
Syracuse Board of Education
Cerebral Palsy School

Beads on Wire

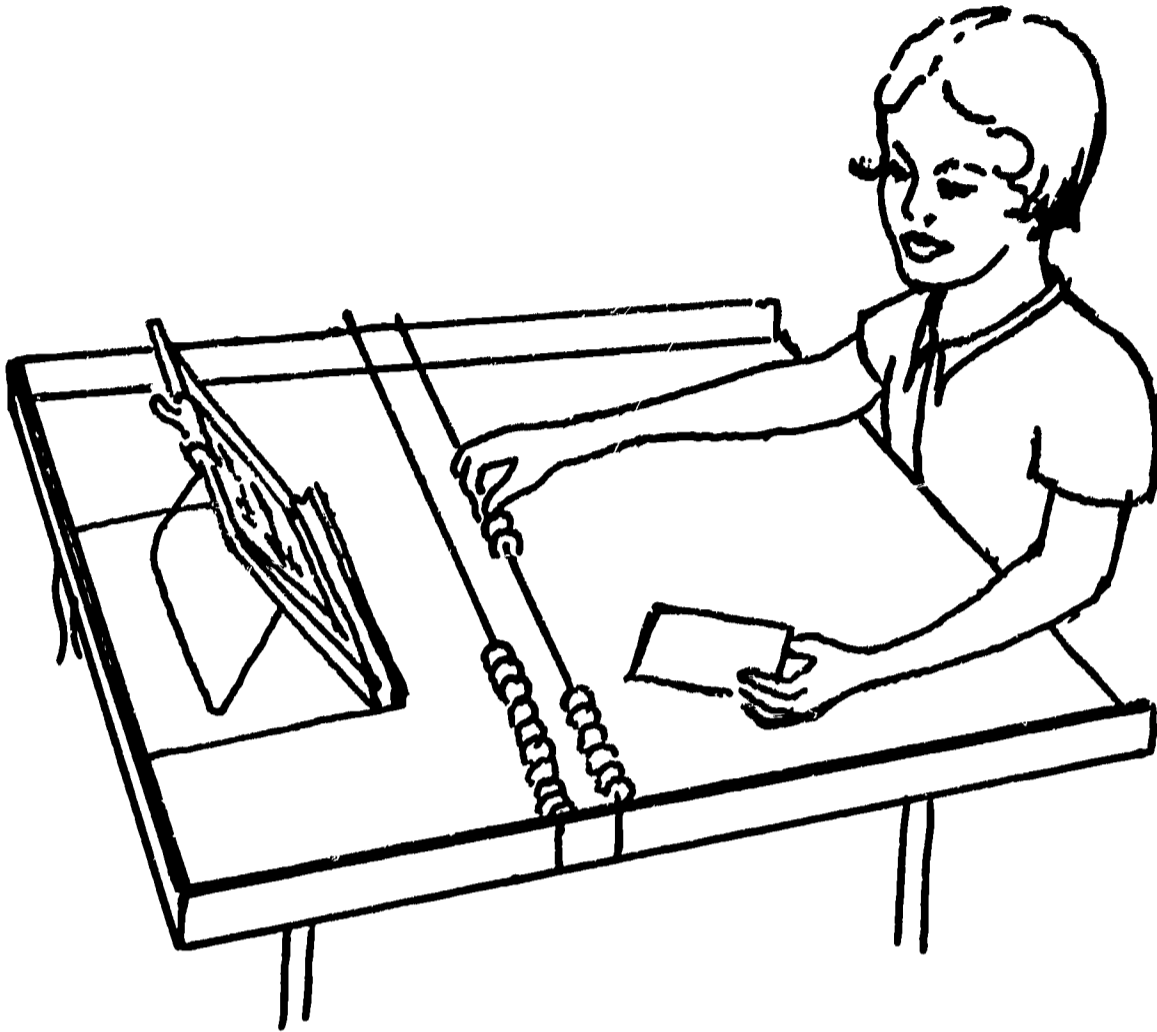

A device used by children who cannot handle the materials suggested in the developmental mathematics program. (Rows of beads on a cardboard, plastic discs, sticks etc.)

Ten wooden beads are strung on rigid wire long enough to fit over the child's table. Two or more rows are used; depending on the child's level. In answering "How many" the child can push the required number of beads from left to right.

In addition of two and three, he can push over two from one row and three from another and count.

In indicating the "fourth" bead he can push the beads apart and leave a space on either side of the "fourth." Dividing beads into groups can be done in the same way.

Answers in subtraction can be indicated by pushing over the required number of beads and taking away the number indicated. The addition may also be used.

Submitted by:

Adele D. Montean
P.S. NO. 135, New York, New York

The Arithmetic Board

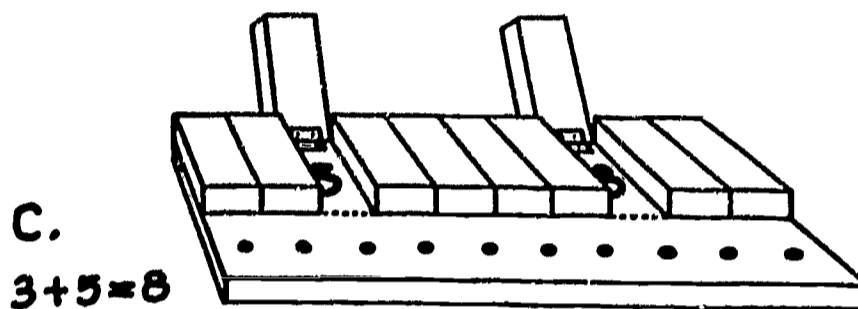
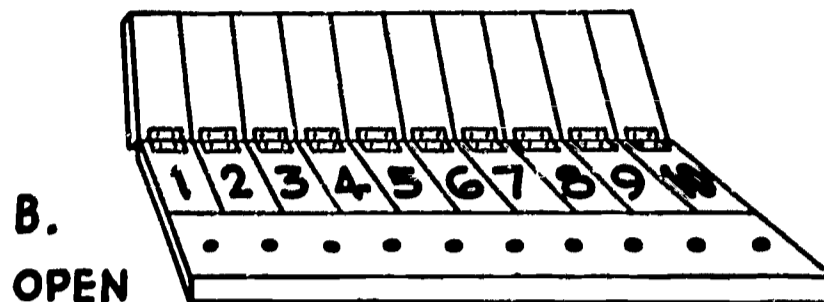
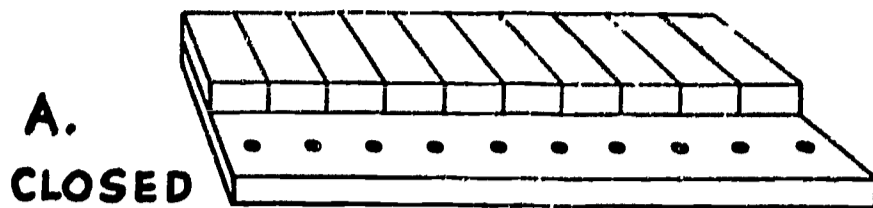

A. The Arithmetic Board is used principally to help children with addition and subtraction problems. It is good for children with cerebral palsy because it is concrete, manipulative and holds their attention for longer periods. It can be made of material heavy enough to withstand rough usage. Basswood, balsa wood and hinges are inexpensive. It is simple enough in construction so that a parent can make one for use at home.

B. Under each flap are the numbers from 1 to 10. Below each flap is a blue circle. If the child is to find that $3 + 5 = 8$, he counts three blue circles and raises the flap to find an 8; saying as he does this, "3 and 5 more are 8."

C. Subtraction problems are done the opposite way. For example: $8-5=3$. The child opens each flap until he has eight opened; then saying, "8 take away 3," he closes three flaps and finds there are five left. Not until the addition procedure is well established and the child has begun to need "The Arithmetic Board" less, should subtraction be started. The Board can also be used for learning to count and recognize the number in its printed form.

Submitted by:
Candace Latham
Eldredge Park School
Binghamton, New York

Arithmetic Table Device

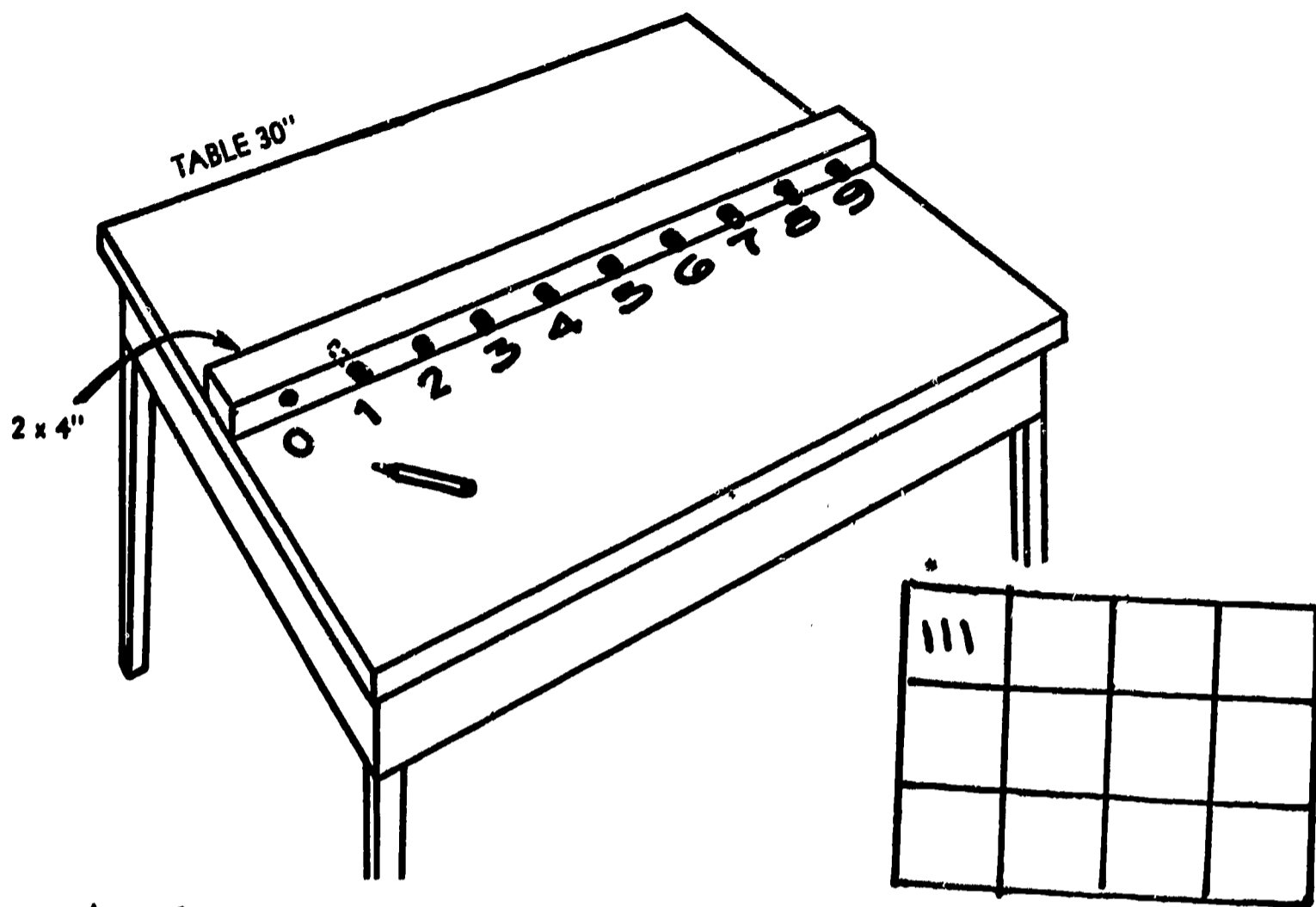

A small substantial table board is constructed with 10 holes large enough to accommodate kindergarten size crayons easily. Each number is represented by a color.

0----Dark blue
 1----Green
 2----Purple
 3----Grey

4----Brown
 5----Yellow
 6----Red

7----Light blue
 8----Orange
 9----Black

Note: Device can also be used to indicate true-false, yes-no, or 1-2-3 answers.

Children unable to write numbers legibly use this device to do their arithmetic assignments. Answers are indicated by marks of color.*

This device permits a child with illegible handwriting to do arithmetic assignments independently. Color marks which do not require finer hand coordination indicate clearly to the teacher the child's number answer.

Submitted by:

Louise Sullivan
 Cerebral Palsy Class
 Syracuse, New York

Number Concepts

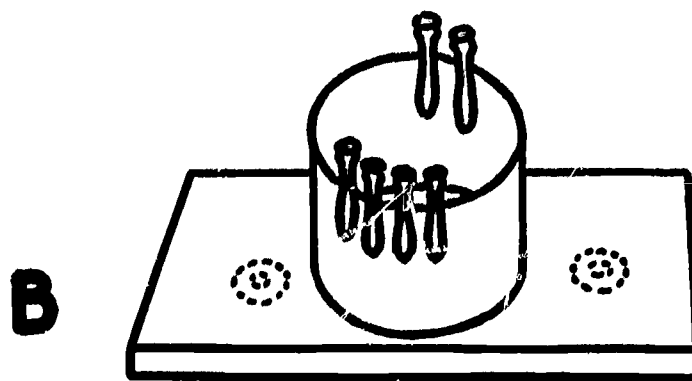
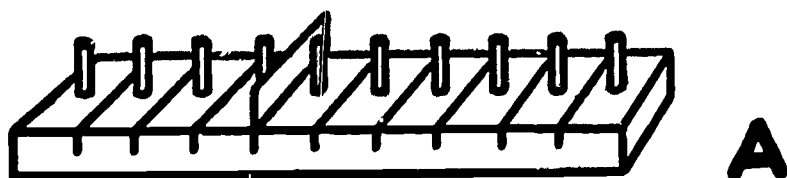

A. This method of teaching number skills allows children to help themselves in understanding number facts and simultaneously experience progress in hand use. The small board with the card inserted in the slit is useful in many other ways.

B. A coffee can is painted a bright color and fastened to a board. Suction cups are fastened underneath the board to hold firmly to the table. It is helpful for children with poor hand coordination. Colored clothespins are used to represent number concepts.

Submitted by:

Anne Remis
School NO. 5
Rochester, New York

Number and Spelling Boxes

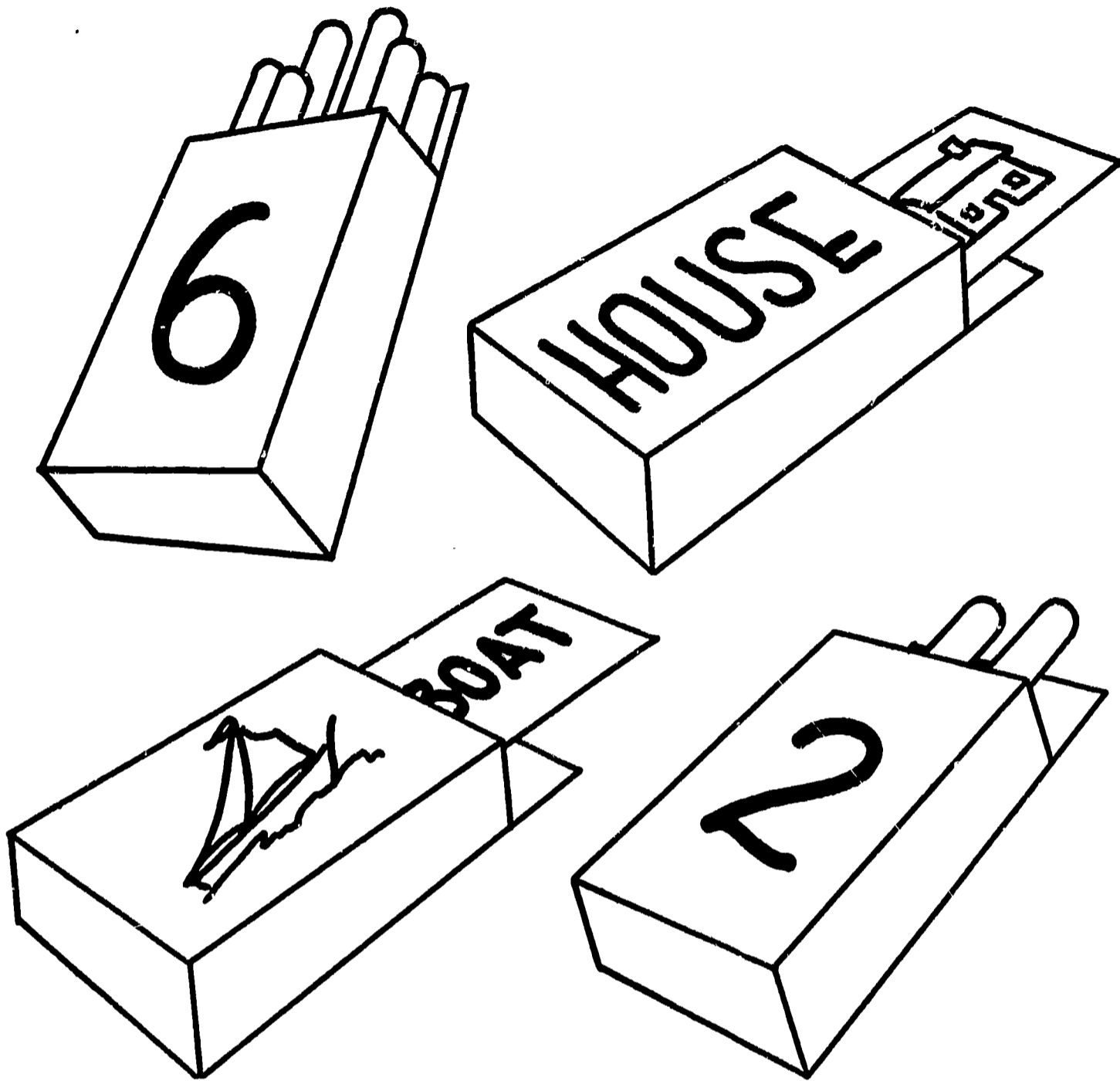

Materials require sample boxes that contain standard brands of cigarettes, poster paper, bright colors, crayons, pictures for spelling words. The box is covered with poster paper. Numbers, pictures, or words are put on the box and shellacked. For numbers, the child inserts correct number of pegs into the box. For spelling, child matches word to picture, matches like pictures, and matches word to word. He may find beginnings of words. Learnings include counting, grouping, adding, spelling, reading, matching, discrimination, and word recognition.

Submitted by:

Evelyn Karpel
Pleasant Valley School
Schenectady, New York

Number Board

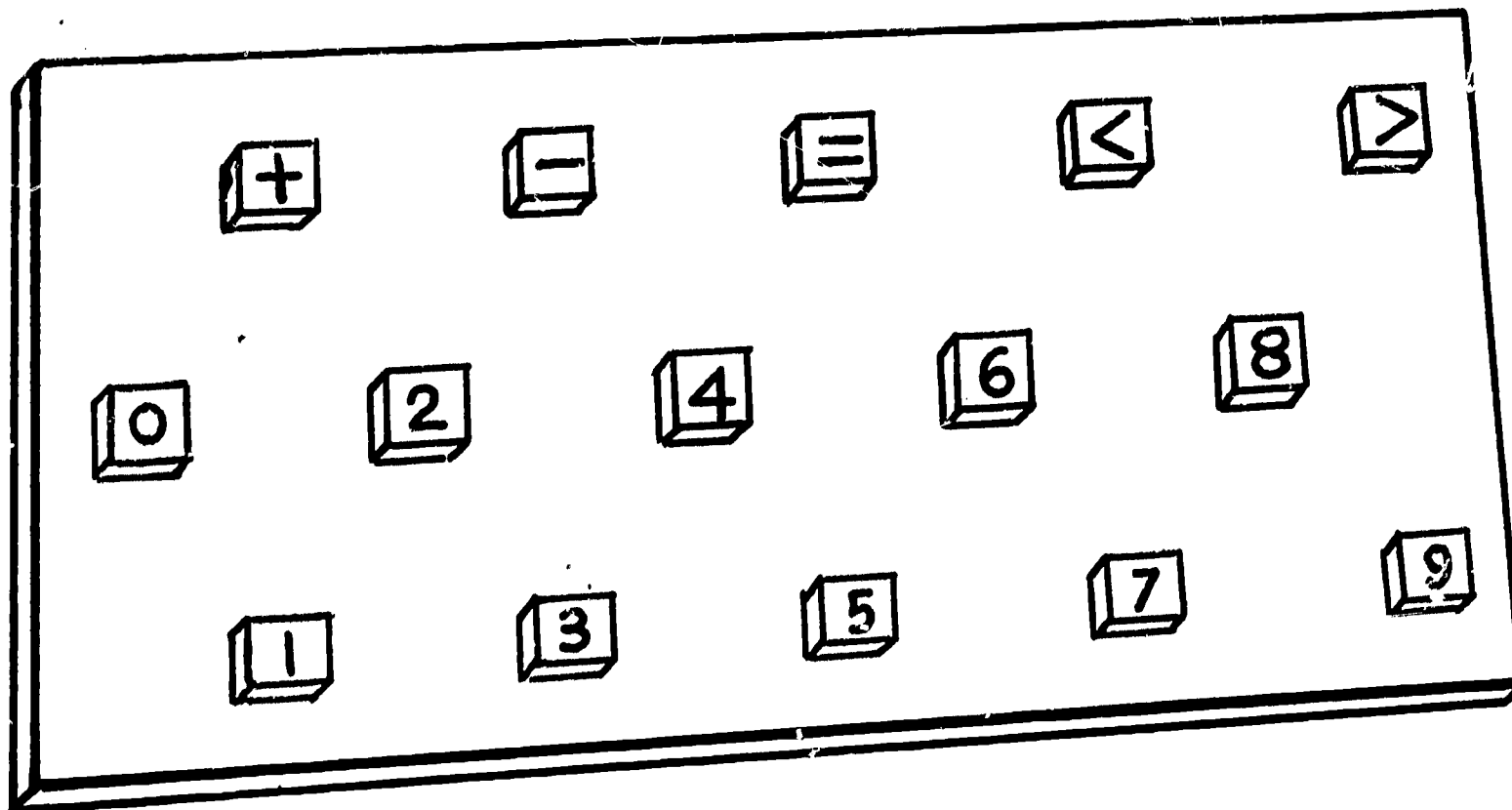

The raised numbers are on blocks attached to a board and spaced approximately two inches apart. The raised numbers eliminate much involuntary hand movement and help the child indicate more clearly where he is pointing.

Submitted by:

Libby Erlitz
Cerebral Palsy School
Roosevelt, New York

Number-Picture-Word Cards

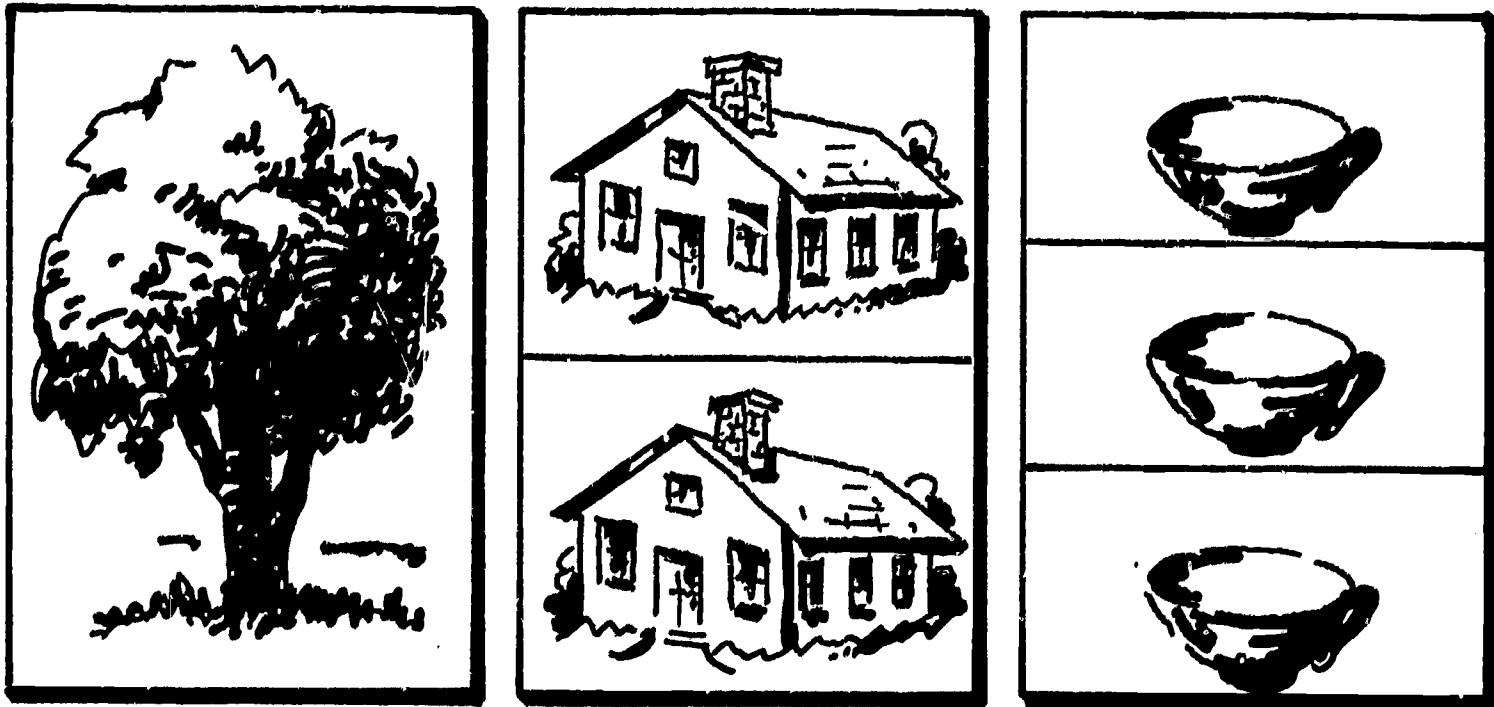

TREE

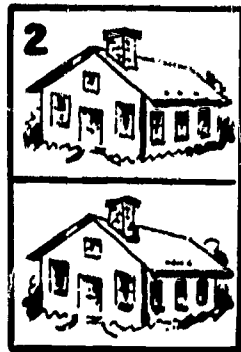

HOUSE

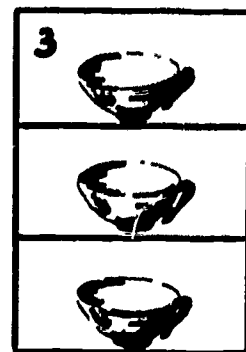

CUP

Large poster cards, 9" x 12" are illustrated with simple pictures of easily recognizable objects; one item on the first card, two identical illustrations on the second card, three identical illustrations on the third card, etc. up to ten cards. Matching picture cards, 3" x 5", are numbered according to amount of items on card and the name of the item is also imprinted on the card. Small cards are distributed to children. The teacher flashes large poster cards. The children having matching cards discard them. It may be played as a game or used as a lesson in learning number values and/or words.

Submitted by:

Evelyn Karpel
Schenectady, New York

Montessori Sticks

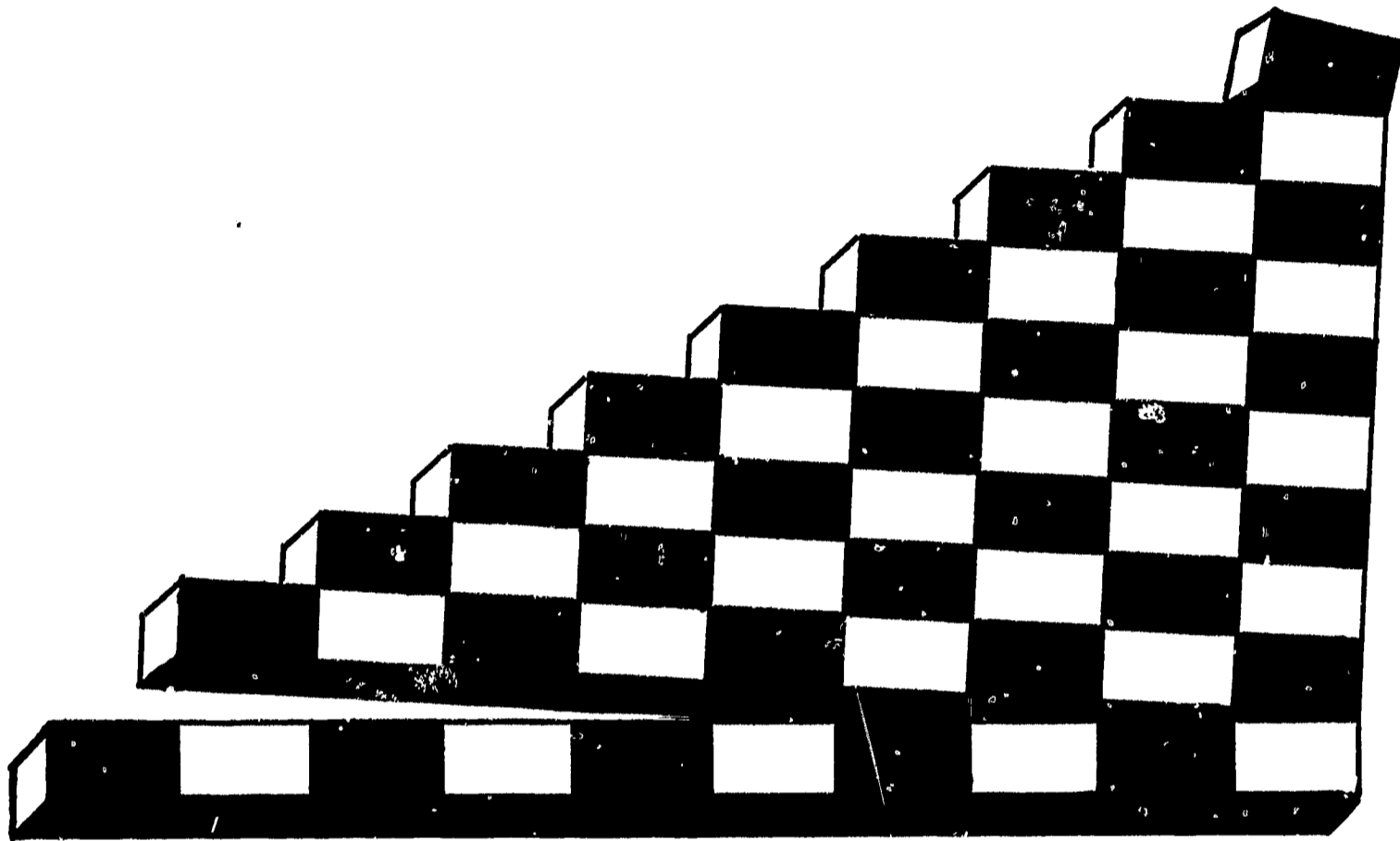

This method may be used to teach the 1 to 10 sequence to children who skip numbers in counting and who require a concrete presentation of the relationship between numbers. Development of addition, subtraction and multiplication may be aided through the use of visual and tactile senses involved in the manipulation. The bottom of the stick is painted a solid dark color for subtraction.

Submitted by:

Evelyn Karpel
Special Class Teacher
Schenectady, New York

Take Away Board

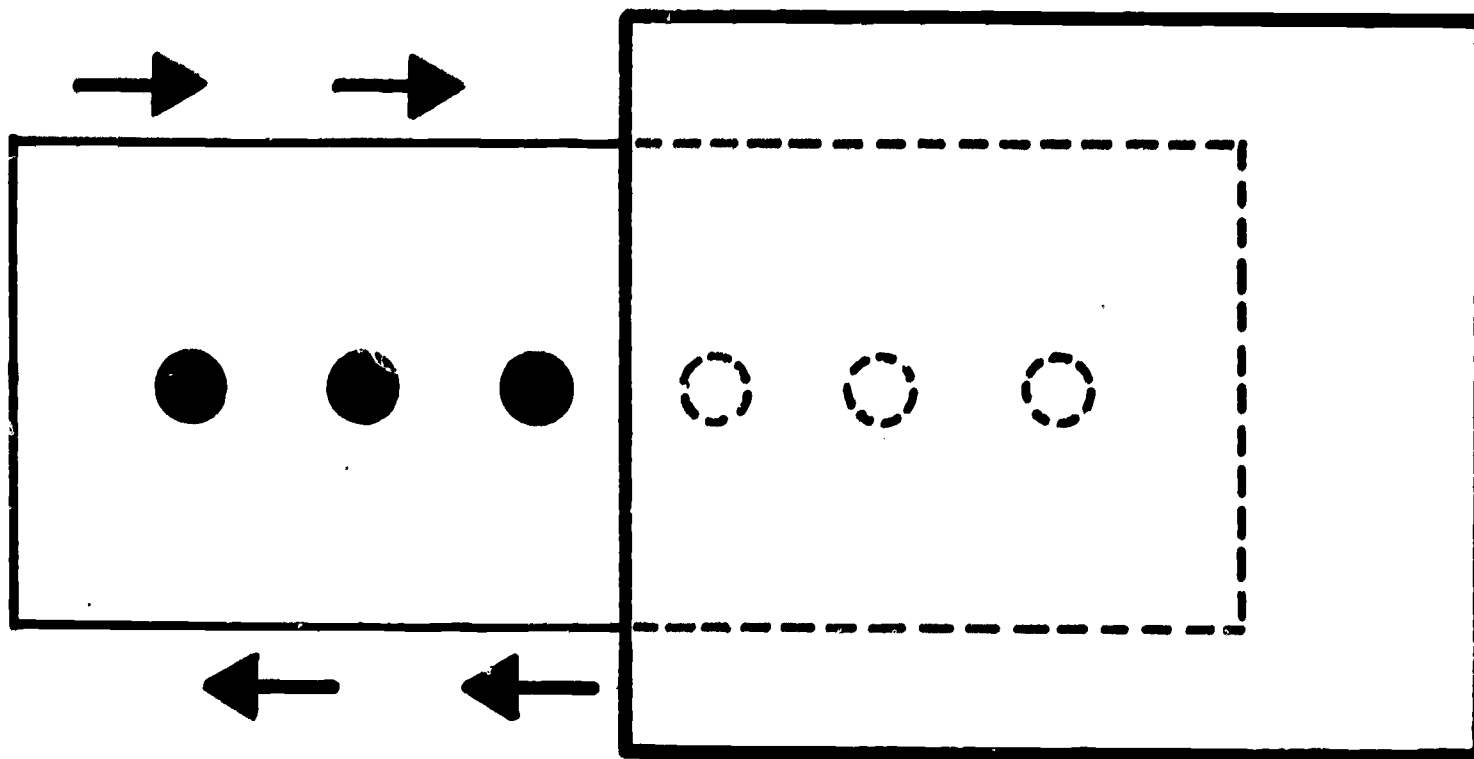

How many is 6 take away 3?

Have a child slide the middle section out until he sees 6 dots. Then have him move it back until 3 dots are missing. He can see his answer very clearly. Number of dots can be increased to subtract larger numbers.

Submitted by:

Mary Wischnacht
P.S. 84
Buffalo, New York

Weather Calendar

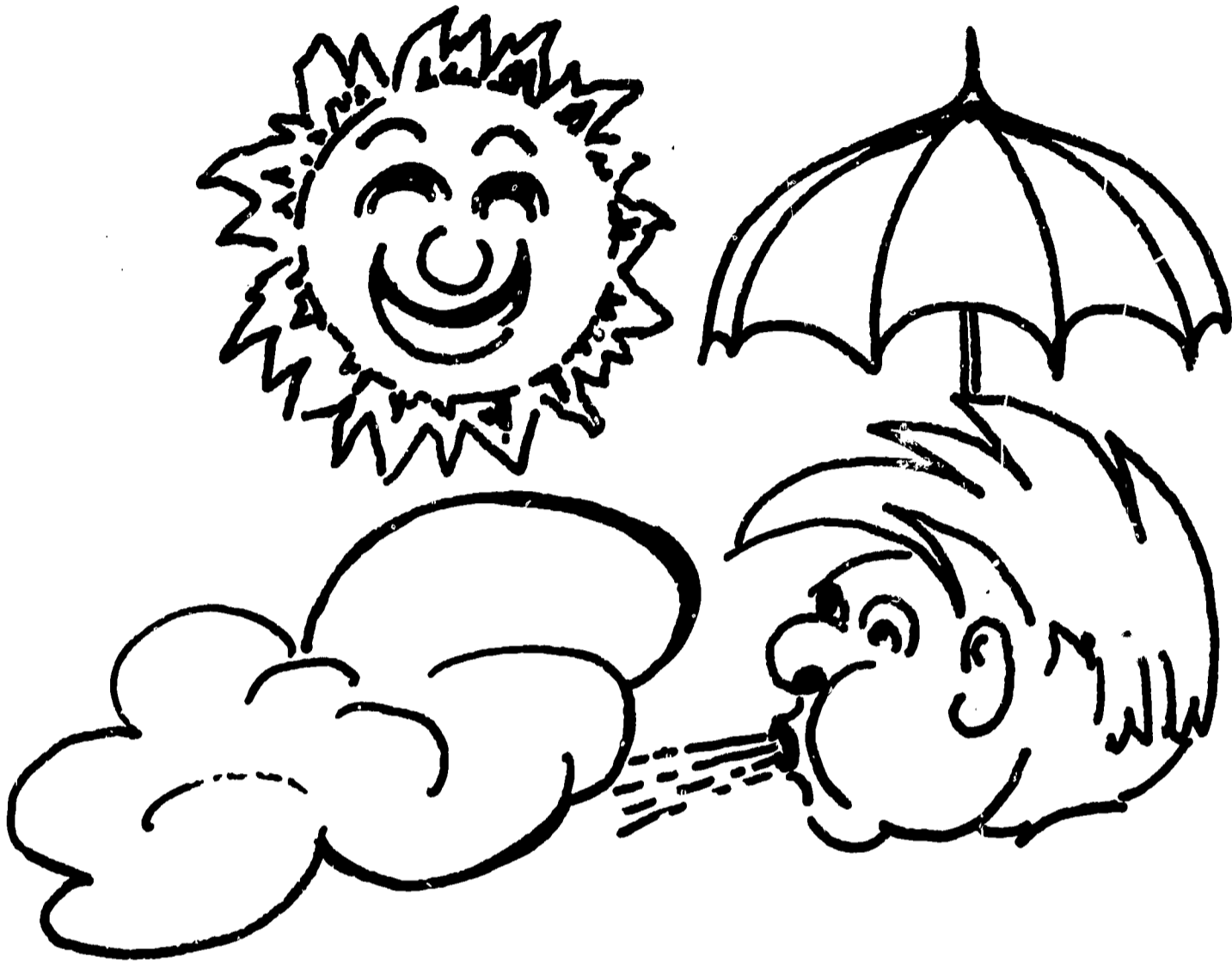

Pictures of sun, cloud, umbrella, etc., to indicate the daily weather forecast are glued to small magnets. A calendar with large numbers, days of the week and name of the month and year is placed on a metal board. Each day the children place correct forecast on date with pictures. Materials may be shellacked for durability.

Submitted by:
Evelyn Karpel
Pleasant Valley School
Schenectady, New York

Visual Math Cards

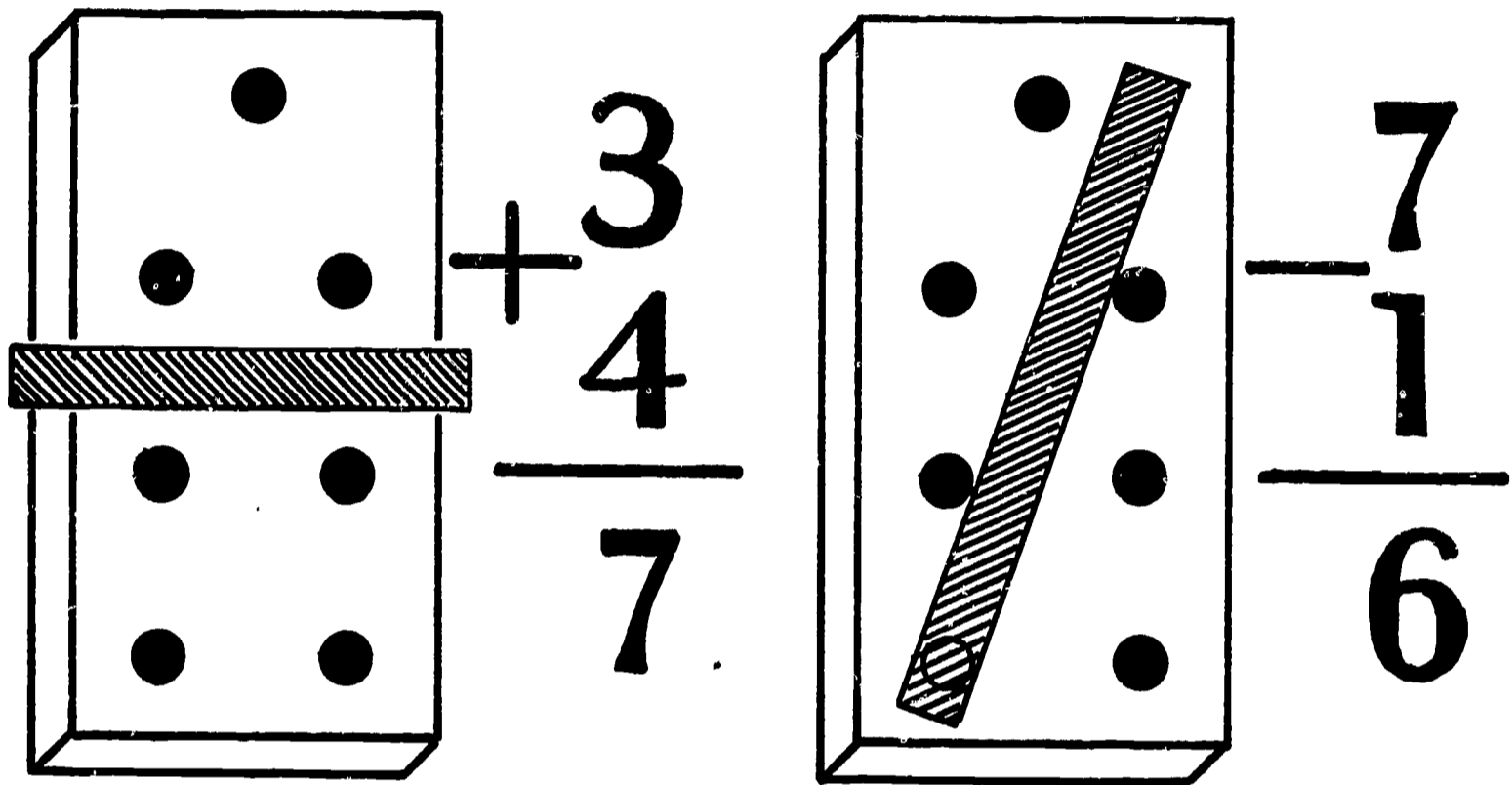

Draw a different number of circles on each 5" x 8" card like dominoes. Use a cardboard liner to separate the circles. Write the top and lower number of circles on chalkboard or at the child's desk. Add or subtract by using a cardboard liner to separate or cover circles.

Submitted by:

Evelyn Karpel
Schenectady, New York

A Method of Eliminating Distractions

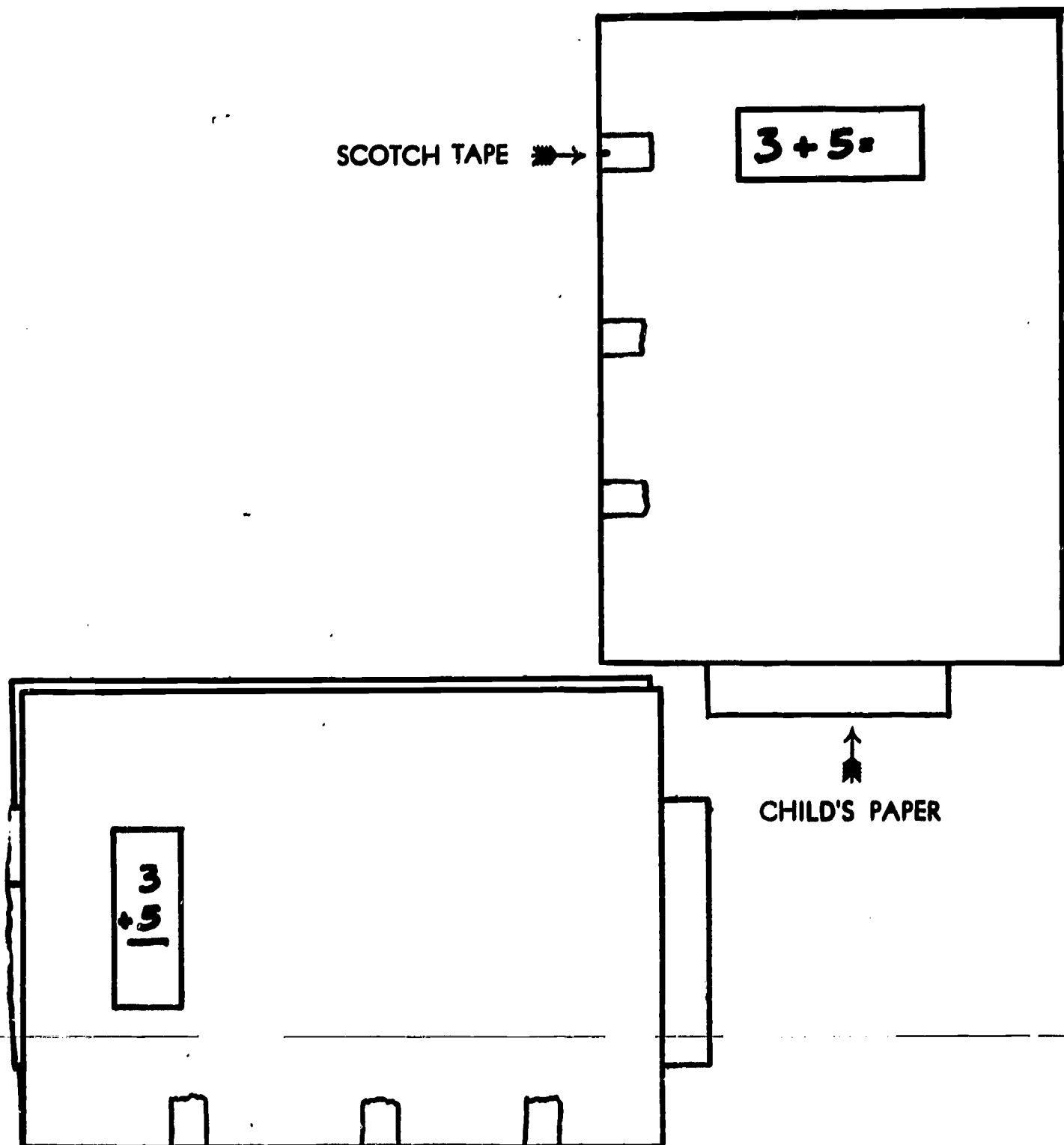

This folder is used to go with an arithmetic board. Only one combination is visible at a time. After several weeks the child prefers to discard this device. It can also be used for word or phrase study.

Submitted by:
Candice Latham
Eldredge Park School
Binghamton, New York

PHYSICAL EQUIPMENT AND FACILITIES

The limited mobility and poor coordination of the child with cerebral palsy require the creative development of devices that may assist the child in his participation in the instructional process. The items submitted for the section on Physical Equipment and Facilities will be helpful to teachers of the cerebral palsied when utilized with adaptations to individual needs.

Pencilholders

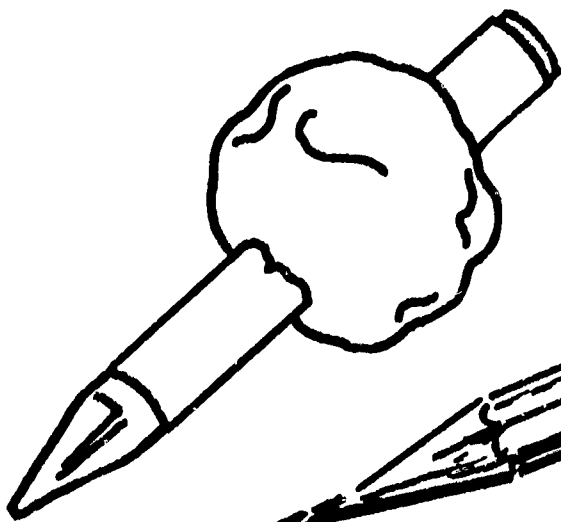

Sponge or clay is wrapped around pencil for better grasp.

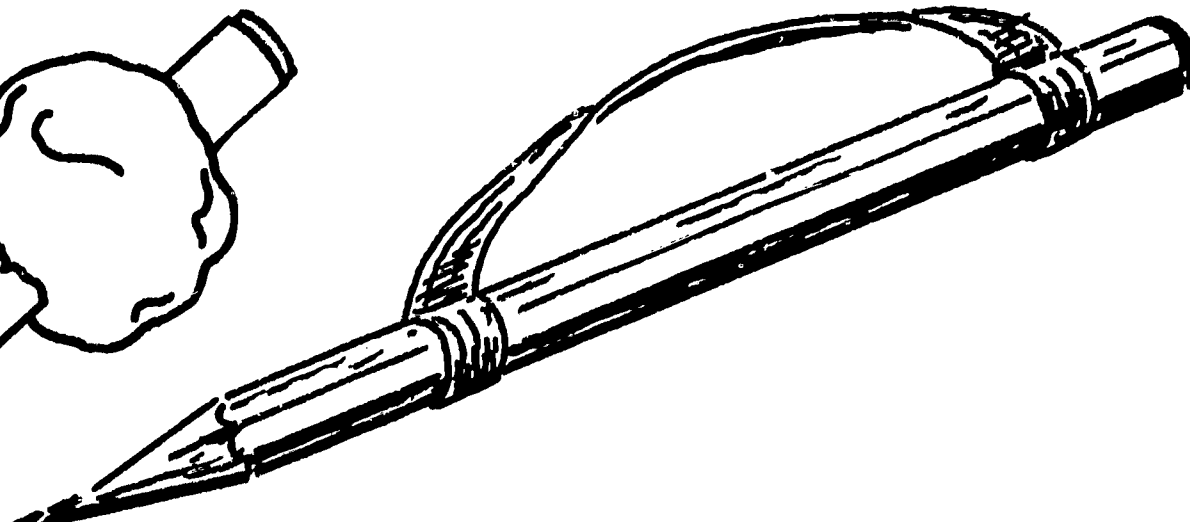

Endloops are sewed to cotton elastic to hold pencil.

Submitted by:
Mrs. Dina C. Ehrlich
Coordinator P.S. 67
Brooklyn, New York

Submitted by:
Mrs. H. Hamburger
Cerebral Palsy School
Roosevelt, New York

(A) Bound Crayons

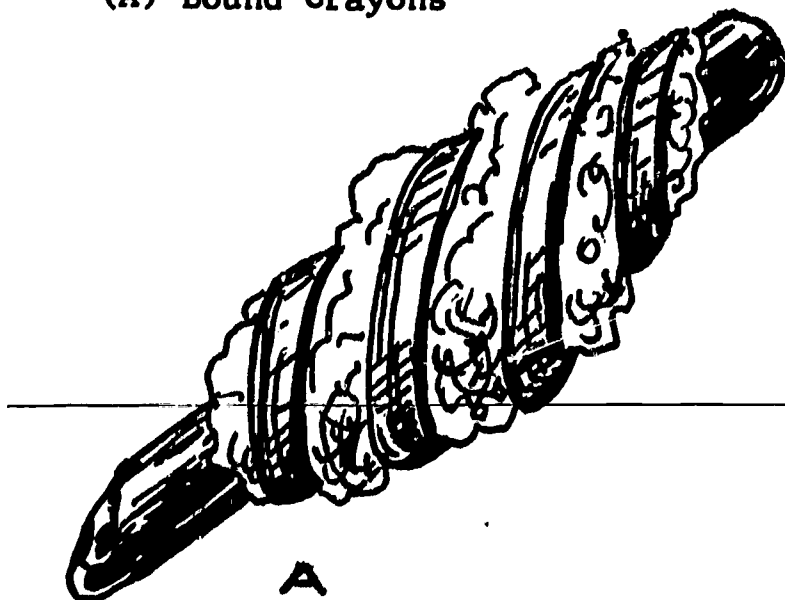

(B) Attached Pencils or Crayons

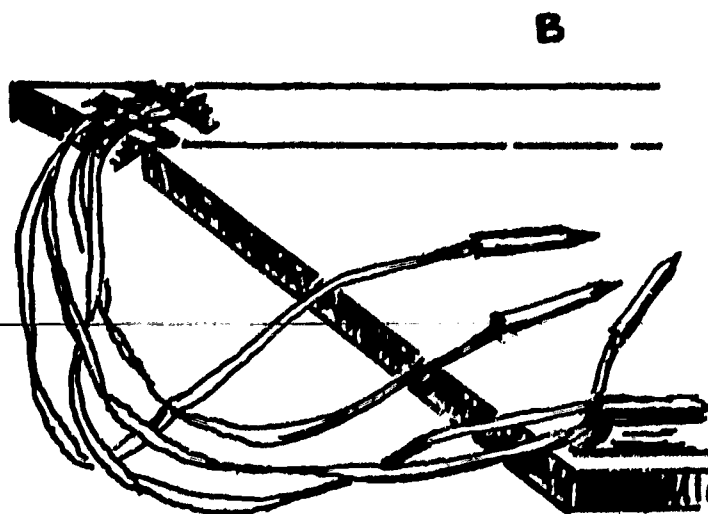

(A) Kindergarten crayons and pencils are bound at point of grasp with cotton covered by adhesive tape.

(B) A 24" length of seam binding is attached to pencils or crayons. The other end of the binding is attached to desk, table, or lap board with masking tape to facilitate retrieval of pencils or crayons.

Submitted by:
Eleanor Crosby
Brentwood, New York

Pencil, Crayon and Chalk Holder

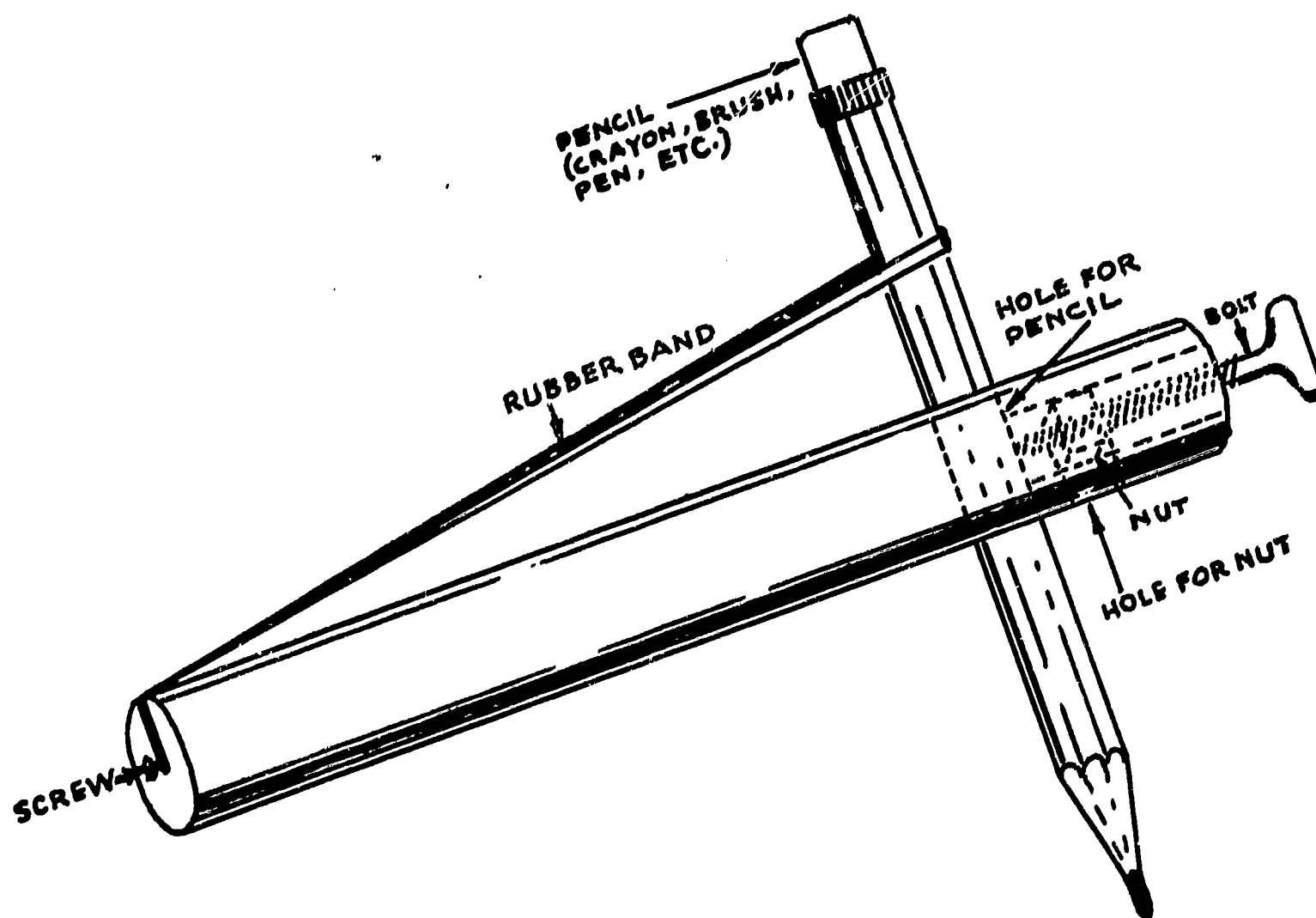

A piece of wood, broom handle or dowel five or six inches long is bored about half an inch from one end to make a hole to fit a pencil. The pencil is made secure by a bolt passed through nut which has been inserted in a hole made for it midway between pencil hole and bolt end. At the opposite end of the dowel a small screw is inserted from which an elastic band is stretched to cover the pencil.

This device secures the pencil and assists the athetoid or spastic with unsteady grasp in holding on to the pencil.

Submitted by:

P. Johnson

P.S. 103, Bronx, New York

From:

Self-Help Devices for Rehabilitation

and

Mary Bouton

Fifth Ward School

Amsterdam, New York

Chalk Holder for Blackboard Work

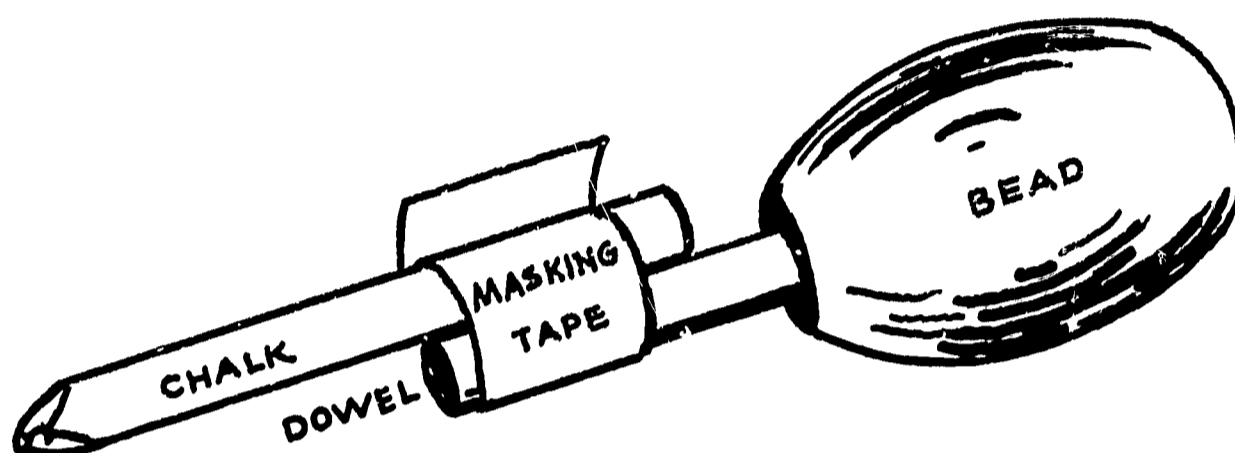

A dowel is glued into the hole of a wooden bead. The bead may be round or elongated and of a size the child finds most comfortable. The exposed portion of the dowel should be about $1\frac{1}{2}$ ". A piece of chalk is attached to the dowel with masking tape.

Submitted by:

Edna Bambay, O.T.R.
HCSO Unit
PS 103X
New York, New York

Non-Skid Desk

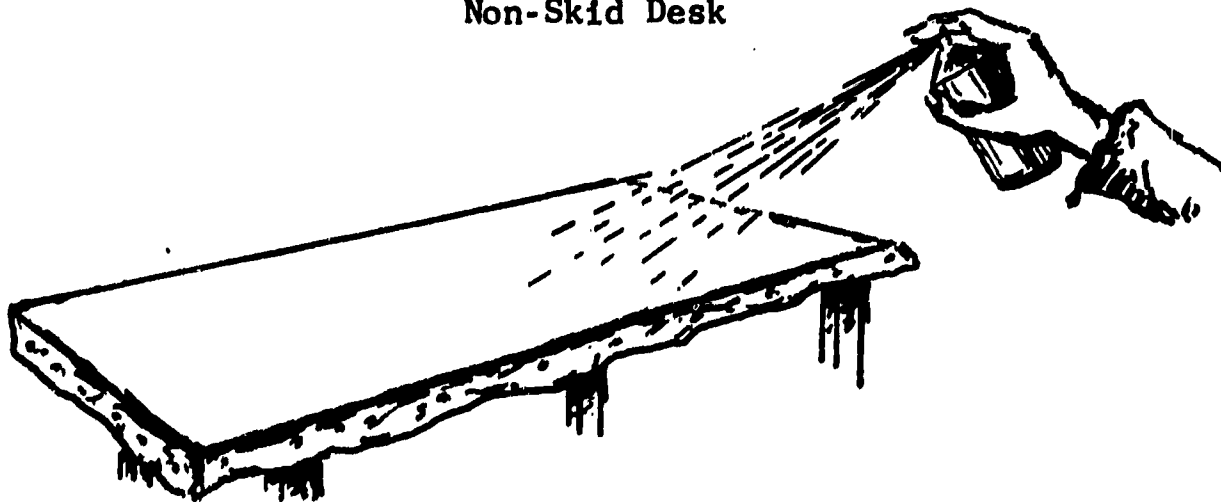

This desk is useful for child with poor coordination who needs paper held in place.

Nail unbleached muslin to desk. Spray muslin with non-skid fluid. Paper placed on muslin remains stationary.

Submitted by:
Lillian Stern
P.S. 85
Bronx, New York

Stationary Paper

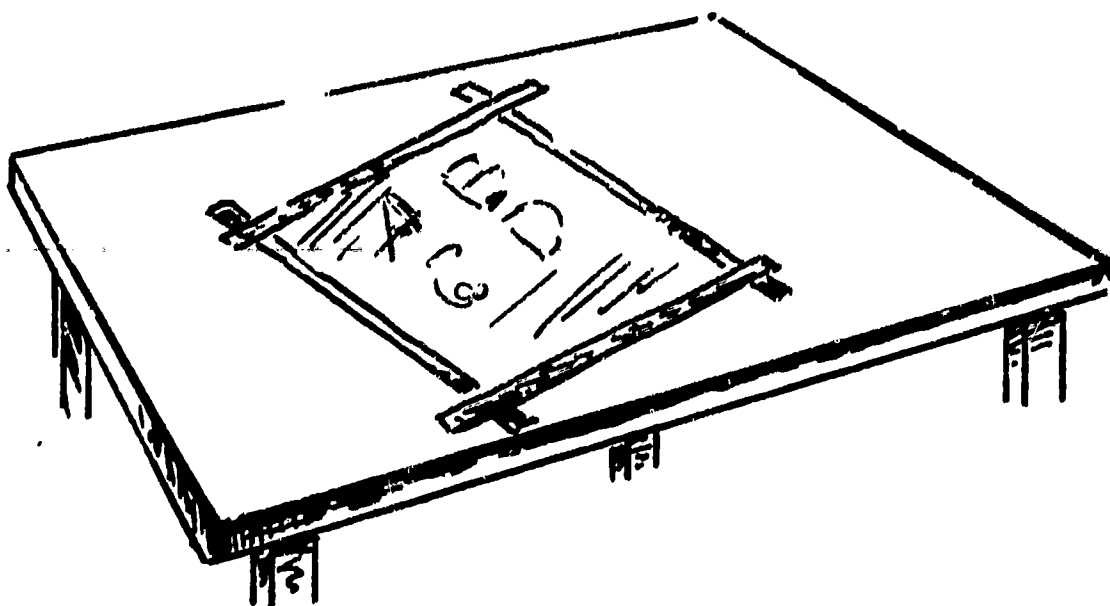

Tape paper to table, desk or lap board with masking tape for the child with involuntary hand movements.

Submitted by:
Eleanor M. Crosby
Southeast School
Brentwood, New York

Paint Water Holder

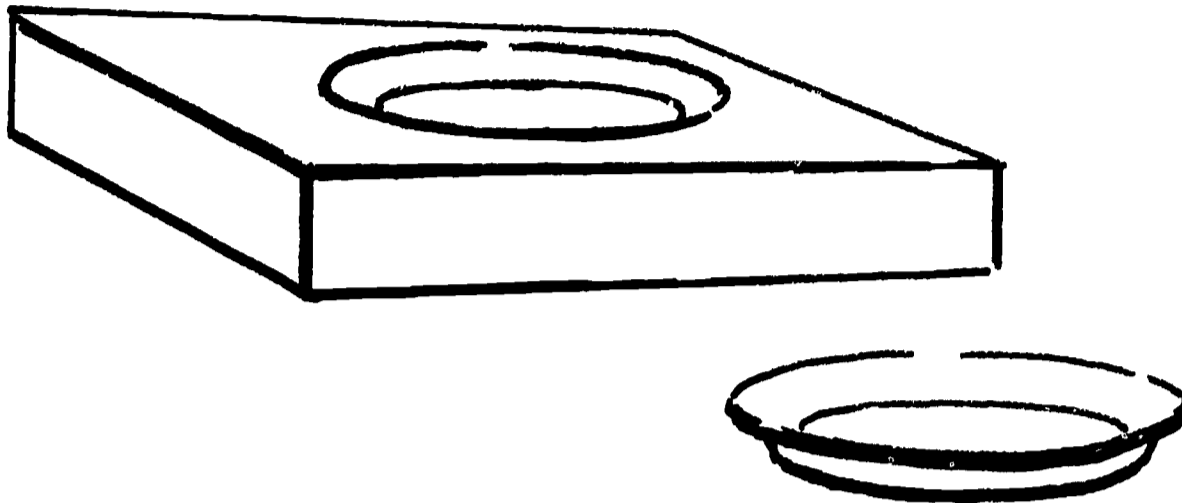

Large shallow pans, 7" x 2½", used for paint water will hold a large amount of water and not tip. Small paint pans are likely to tip. However, small pans can be used when placed in 5½" squares of wood, 1" thick, with a tapered hole to fit the small pan.

Weighted Bracelet

SHEET LEAD DISCS SEWED BETWEEN LAYERS OF CLOTH

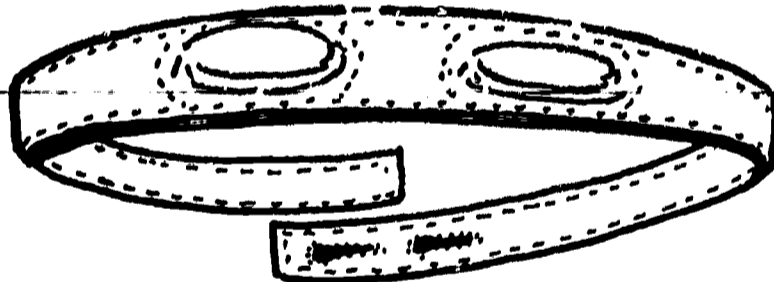

Child wears weighted bracelet on dominant hand. This serves as a reminder to the child of his dominant hand. It aids in motor coordination and helps develop motor skills necessary in writing.

Submitted by:

Evelyn Karpel
Schenectady, New York

Cut-Up Textbook

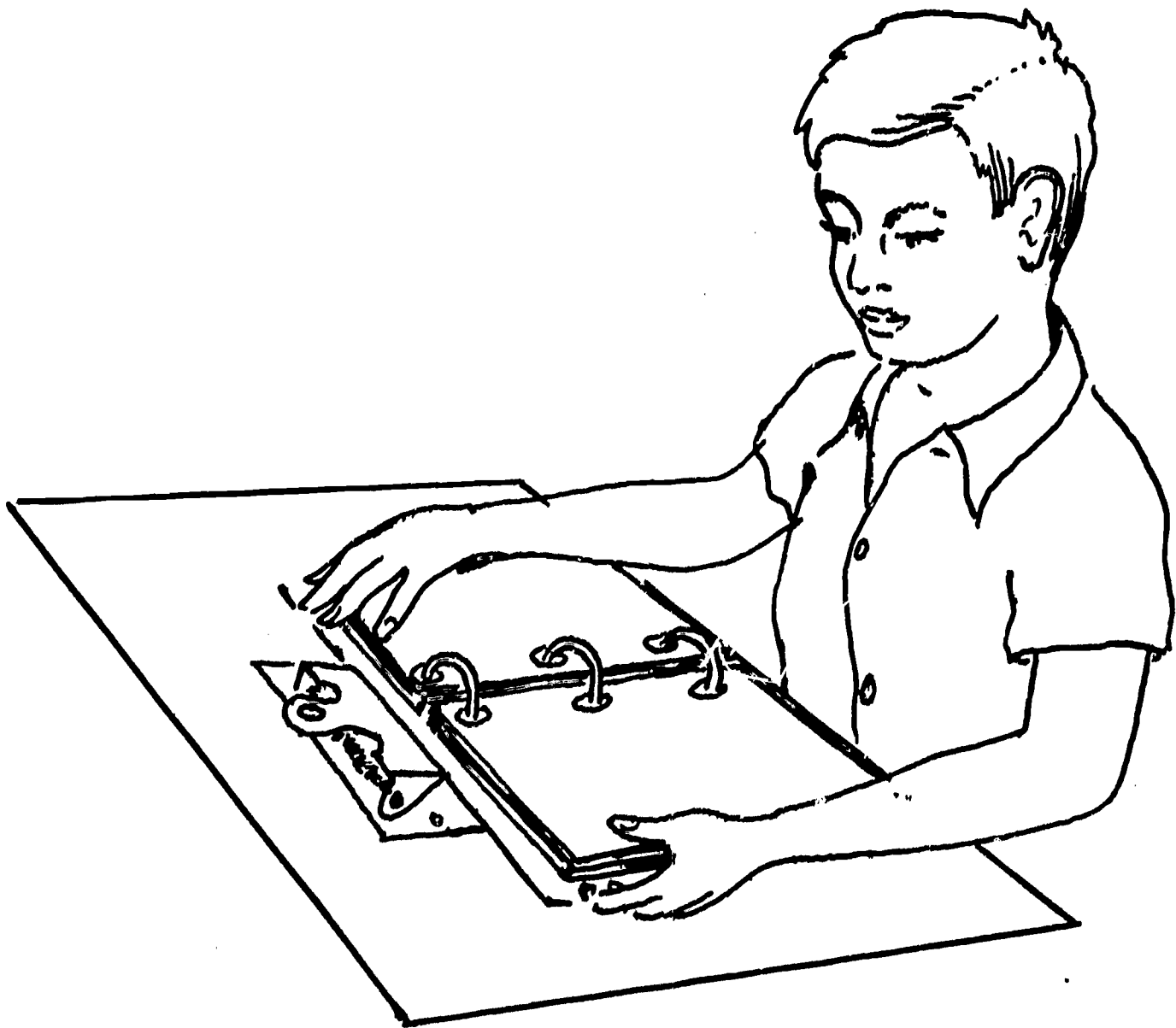

Children who have poor use of hands can turn pages much more easily if the textbook is cut from its binding and holes punched to fit a looseleaf notebook. The book then can be clamped tightly to a heavy bookstand with large clips. If necessary, the stand can then be clamped to the table. The advantage of looseleaf readers is that the pages will lie flat after they are turned, instead of flipping back again as so often happens if the binding is new and stiff.

Some children can turn the pages more easily by using a pencil or short stick to which a piece of rubber sponge has been glued.

Submitted by:

Adele Montean
P. S. No. 135
New York, New York

Plastic Covered Pages

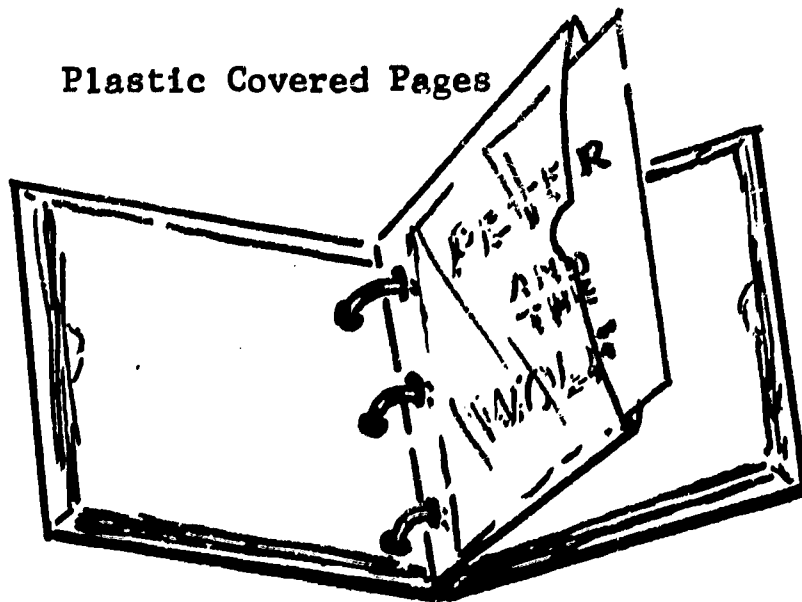

Pages from basic readers are mounted on construction paper and are enclosed in plastic sheets. They are then bound together loosely with three large rings which are inserted in holes punched in each paper and sheet. Pages mounted on construction paper helps child to focus attention on printed words.

Submitted by:
Eleanor Crosby
Brentwood

Study on Reading Stand

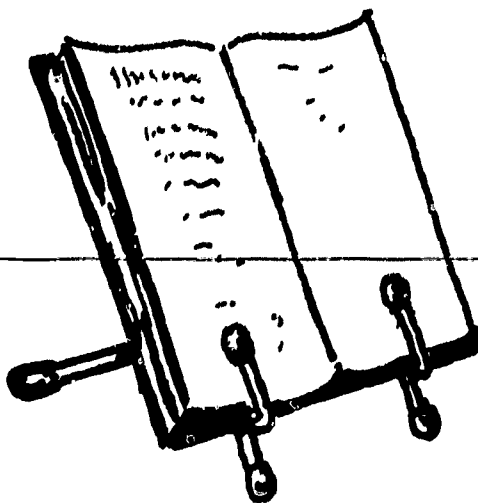

This stand holds small or large book easily. It reduces eye strain for those spastics who cannot hold a book still enough to read, also for those who have little or no use of hands. Stand is adjustable. The folding legs make it easy to set up and store away. It fits brief case or desk. It can be purchased through: Protecto Mfg. Co., 237 East Front Street, Owatonna, Minnesota, Price \$.50.

Submitted by:
Mary Wischnacht
P.S. 84
Buffalo, New York

Tilt-Top Desk-Table



This Tilt-Top Desk-Table was specially built for use with cerebral palsied children by the Schenectady City School District. This tilt-top desk can be raised so papers can be held up by masking tape as a child tries to write if one hand is involved. It also can be arranged for book work or art activity. Wheel chairs can be pushed under it. It is adjustable and can be adapted to the size of children. Plans and specifications are available from the drawing on page 51.

Submitted by:

Jayne B. Rycheck
Supervisor of
Special Education
Schenectady, New York

Tilt-Top Desk-Table (Specifications)

TILT-TOP TABLE - Desk	
SUNNYVIEW HOSPITAL-School	
SCH'BY DEPT. OF EDUCATION	
CKED. Mrs. Jayne B. Rycheck	DR. BY <i>JRC</i>
BY Supervisor Special Education	DATE 6-29-30-65

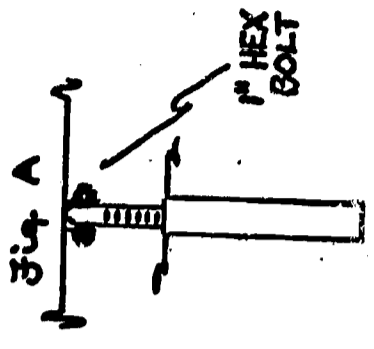
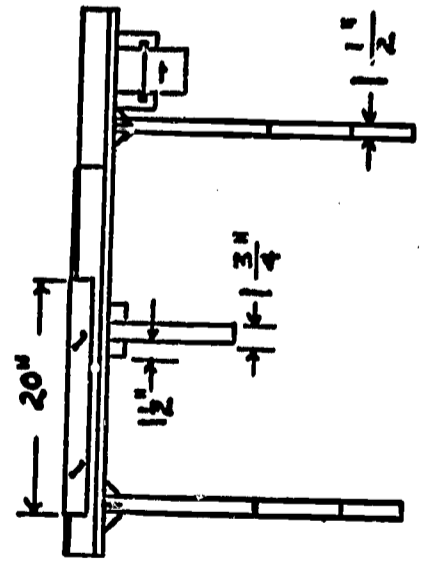
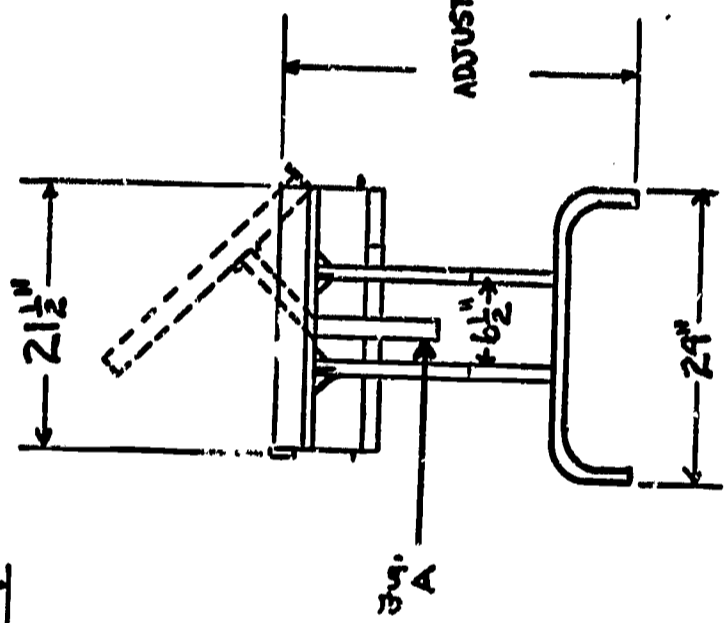
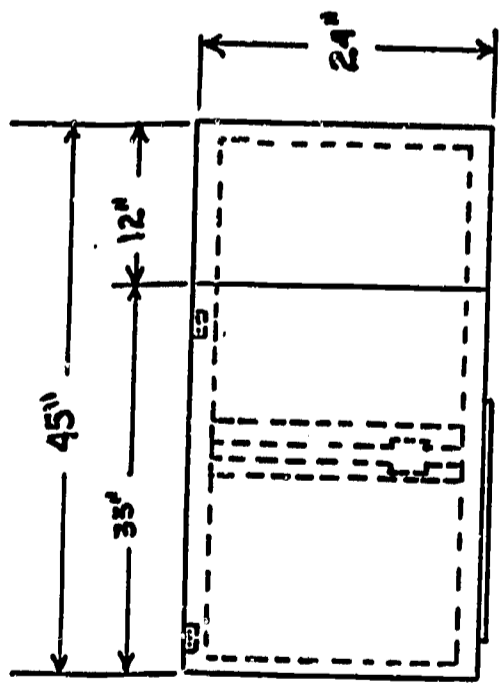

50A

Shenandoah, N.Y.
Shenandoah City School District

10

Electric Typewriter



Reading and writing is aided by the use of the electric typewriter. The child with weak muscles is able to operate it because of the light touch required. A keyboard attachment helps those with poor muscles control.

Submitted by:
Evelyn Karpel
Special Class Teacher
Jayne B. Rycheck
Supervisor of
Special Education
Schenectady, New York

Tape Recorder

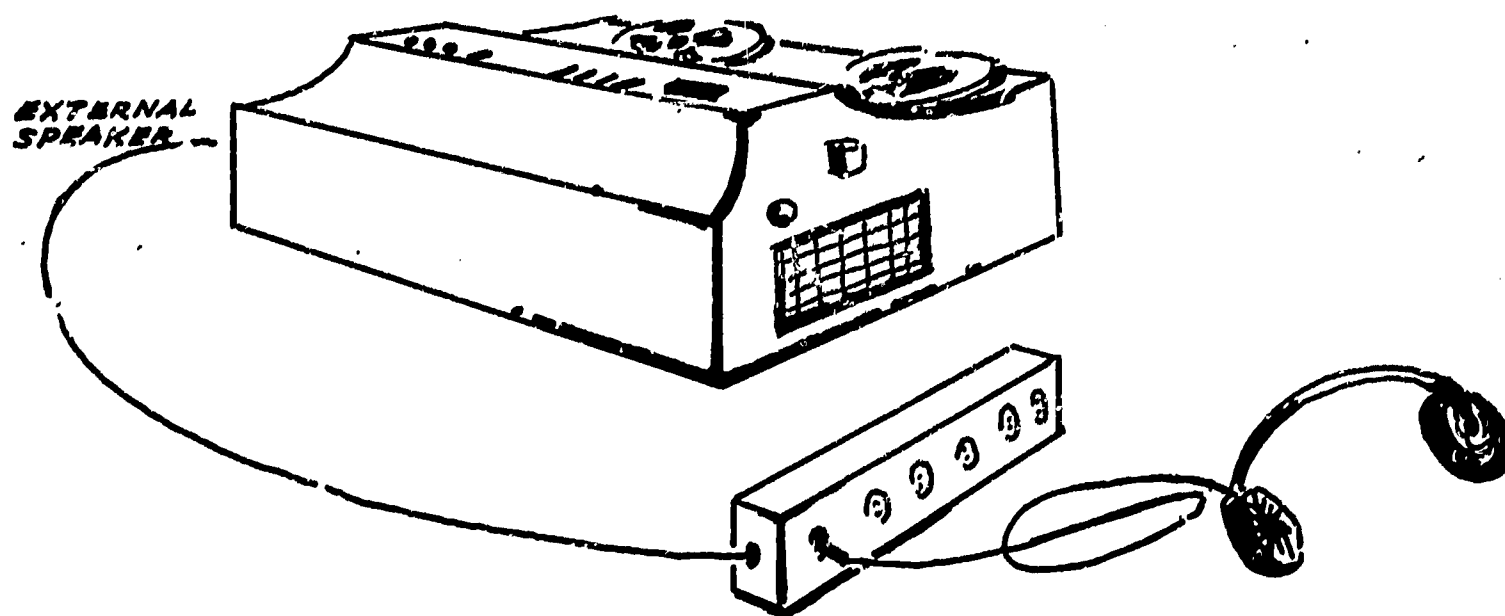

The tape recorder can be used in language development, spelling, auditory discrimination, phonics, plays, etc. A helpful attachment is a box-like device that is attached to the external speaker. It has six outlets to plug in individual earphones.

A pre-recorded lesson can be set up for a group of children, some with slight hearing losses, without disturbing the other children in the class. If an individual child needs work in any of the above areas, he can record and listen on an individual basis.

Submitted by:
Marion Mattimore
Albany Board of Education
Cerebral Palsy Class

BIBLIOGRAPHY OF ADDITIONAL SOURCES

This revision of Teaching Aids for Children with Cerebral Palsy does not purport to be all-inclusive in presenting concrete devices and techniques employed by teachers. Rather it is descriptive of teaching aids used successfully and may be helpful and suggestive to other teachers in presenting their instructional programs. The bibliography that follows provides some additional sources for teachers seeking ideas regarding the use of other teaching aids. How teachers will employ teaching aids and what modifications they will make to meet the varying needs of their pupils will depend on the particular teacher's creativity and understanding of the children in her classroom.

BIBLIOGRAPHY OF ADDITIONAL SOURCES

- Academic Aids, Grades 2-8. Creative Playthings, Inc. P.O. Box 1100, Princeton, New Jersey
- Adams, William. Educational Aids for Developing Perceptual Abilities Necessary for Learning to Read and Write. Perception Aids, Inc., 930 Penobscot Building, Detroit, Michigan
- Alpha Chi Omega. Toy Book: Self-Help Toys to Make for Handicapped Children. Alpha Chi Omega National Headquarters, 3445 Washington Boulevard, Indianapolis, Indiana 46205
- Aphonic Communication for Those with Cerebral Palsy. Anne Remis, Study Group Chairman, United Cerebral Palsy Associations of New York State, 220 W. 42nd Street, New York, New York 10036
- Buckley, Isabelle. Play N Talk. School of Education, P.O. Box 46666, Hollywood 46, California
- Cheves, Ruth. Visual-Motor Perception Teaching Materials. Teaching Resources Inc., 334 Boylston Street, Boston, Massachusetts 02116
- Children's Music Center, Inc. 5373 West Pico Boulevard, Los Angeles, California 90019
- Community Playthings. Rifton, New York
- A Curriculum Focus for the Child with Cerebral Palsy and Mental Retardation. Joseph Fenton, Study Group Coordinator. United Cerebral Palsy Associations of New York State, 220 W. 42nd Street, New York, New York 10036
- Developing Listening and Speaking Skills with Materials. The Judy Company. 310 N. Second Street, Minneapolis, Minnesota 55401
- Dorward, Barbara. Teaching Aids and Toys for Handicapped Children. Publication Sales Section, N.E.A., 1201 Sixteenth Street, N.W., Washington 36, D.C.
- Folding Perception Cards #227 Number Facts 1-9. Ideal School Supply Company, Chicago, Illinois
- Frostig, Marianne and Horne, David. Program for the Development of Visual Perception. Follett Publishing Company, Department D.M., 1010 West Washington Boulevard, Chicago, Illinois 60607
- Gallagher, A.M. & J.J. Keyboard Town Story. R.W. Parkinson and Associates, 704 Mumford Drive, Urbana, Illinois
- Instructo #55, Flannel Board. Instructo Products, Philadelphia, Pennsylvania

- Interesting Things to Do for Grades 1 and 2. Scott, Foresman and Company, Chicago, Illinois
- Kirk, Samuel A. and McCarthy, James J. The Illinois Test of Psycholinguistic Abilities. Urbana: University of Illinois Press, 1961
- One Hundred Twenty-Five Low-Cost-No Cost Projects for Home, School and Hospital. Dixon State School, 2600 Brinton Avenue, Dixon, Illinois
- Playground Corporation of America. 524 W. 43rd Street, New York 36, New York
- Rosenberg, Charlot. Simple Self-Help Devices to Make for the Handicapped. Damon and Kay Printing Company, 1734 Wildwood Road, N.E. Atlanta, Georgia 30306, 1965
- Tactile-Kinesthetic Educational Aids. Young Playways, 3404 Connecticut N.W., Washington 8, D.C.
- Tactile-Kinesthetic Safety Word Packet. No. 11 and No. 8A. Webster Publishing Co., 1154 Reco Road, St. Louis, Missouri
- Teaching Typing to Mentally Retarded Children. R. W. Parkinson and Associates, 704 Mumford Drive, Urbana, Illinois

The above list does not constitute an endorsement by New York State Education Department of any commercial products or firms.